



Cathodic Protection

Course Number: EE-02-802

PDH: 4

Approved for: AK, AL, AR, GA, IA, IL, IN, KS, KY, LA, MD, ME, MI, MN, MO, MS, MT, NC, ND, NE, NH, NJ, NM, NV, OH, OK, OR, PA, SC, SD, TN, TX, UT, VA, VT, WI, WV, and WY

New Jersey Professional Competency Approval #24GP00025600

North Carolina Approved Sponsor #S-0695

Maryland Approved Provider of Continuing Professional Competency

Indiana Continuing Education Provider #CE21800088

This document is the course text. You may review this material at your leisure before or after you purchase the course. In order to obtain credit for this course, complete the following steps:

1) Log in to My Account and purchase the course. If you don't have an account, go to New User to create an account.

2) After the course has been purchased, review the technical material and then complete the quiz at your convenience.

3) A Certificate of Completion is available once you pass the exam (70% or greater). If a passing grade is not obtained, you may take the quiz as many times as necessary until a passing grade is obtained (up to one year from the purchase date).

If you have any questions or technical difficulties, please call (508) 298-4787 or email us at admin@PDH-Pro.com.



UNIFIED FACILITIES CRITERIA (UFC)

CATHODIC PROTECTION



APPROVED FOR PUBLIC RELEASE; DISTRIBUTION UNLIMITED

UNIFIED FACILITIES CRITERIA (UFC)

CATHODIC PROTECTION

Any copyrighted material included in this UFC is identified at its point of use. Use of the copyrighted material apart from this UFC must have the permission of the copyright holder.

U.S. ARMY CORPS OF ENGINEERS (Preparing Activity)

NAVAL FACILITIES ENGINEERING COMMAND

AIR FORCE CIVIL ENGINEER SUPPORT AGENCY

Record of Changes (changes are indicated by \1\ ... /1/)

Change No.	Date	Location

This UFC supersedes TM 5-811-7, dated 22 April 1985. The format of this UFC does not conform to UFC 1-300-01; however, the format will be adjusted to conform at the next revision. The body of this UFC is a document of a different number.

FOREWORD

v1\

The Unified Facilities Criteria (UFC) system is prescribed by MIL-STD 3007 and provides planning, design, construction, sustainment, restoration, and modernization criteria, and applies to the Military Departments, the Defense Agencies, and the DoD Field Activities in accordance with [USD\(AT&L\) Memorandum](#) dated 29 May 2002. UFC will be used for all DoD projects and work for other customers where appropriate. All construction outside of the United States is also governed by Status of forces Agreements (SOFA), Host Nation Funded Construction Agreements (HNFA), and in some instances, Bilateral Infrastructure Agreements (BIA.) Therefore, the acquisition team must ensure compliance with the more stringent of the UFC, the SOFA, the HNFA, and the BIA, as applicable.

UFC are living documents and will be periodically reviewed, updated, and made available to users as part of the Services' responsibility for providing technical criteria for military construction. Headquarters, U.S. Army Corps of Engineers (HQUSACE), Naval Facilities Engineering Command (NAVFAC), and Air Force Civil Engineer Support Agency (AFCEA) are responsible for administration of the UFC system. Defense agencies should contact the preparing service for document interpretation and improvements. Technical content of UFC is the responsibility of the cognizant DoD working group. Recommended changes with supporting rationale should be sent to the respective service proponent office by the following electronic form: [Criteria Change Request \(CCR\)](#). The form is also accessible from the Internet sites listed below.

UFC are effective upon issuance and are distributed only in electronic media from the following source:

- Whole Building Design Guide web site <http://dod.wbdg.org/>.

Hard copies of UFC printed from electronic media should be checked against the current electronic version prior to use to ensure that they are current.

AUTHORIZED BY:



DONALD L. BASHAM, P.E.
Chief, Engineering and Construction
U.S. Army Corps of Engineers



DR. JAMES W. WRIGHT, P.E.
Chief Engineer
Naval Facilities Engineering Command

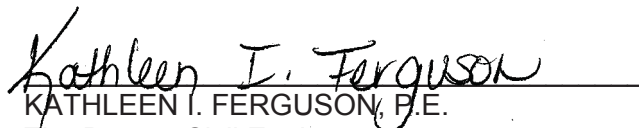

KATHLEEN I. FERGUSON, P.E.
The Deputy Civil Engineer
DCS/Installations & Logistics
Department of the Air Force



Dr. GET W. MOY, P.E.
Director, Installations Requirements and
Management
Office of the Deputy Under Secretary of Defense
(Installations and Environment)

REPRODUCTION AUTHORIZATION/RESTRICTIONS

This manual has been prepared by or for the Government and, except to the extent indicated below, is public property and not subject to copyright.

Copyrighted material included in the manual has been used with the knowledge and permission of the proprietors and is acknowledged as such at point of use. Anyone wishing to make further use of any copyrighted material, by *itself and apart from this text* should seek necessary permission directly from the proprietors.

Reprints or republications of this manual should include a credit substantially as follows: "Department of the Army, USA, Technical Manual TM 5-811-7, Electrical Protection, Cathodic Protection."

If the reprint or republication includes *copyrighted* material, the credit should also state: "Anyone wishing to make further use of copyrighted material, *by itself and apart from this text*, should seek necessary permission directly from the proprietors."

ELECTRICAL DESIGN, CATHODIC PROTECTION

	<i>Paragraph</i>	<i>Page</i>
CHAPTER 1. INTRODUCTION TO CATHODIC PROTECTION		
Purpose	1-1	1-1
References	1-2	1-1
Corrosion	1-3	1-1
Cathodic protection	1-5	1-1
Types of cathodic protection systems		
2. CATHODIC PROTECTION DESIGN		
Required information	2-1	2-1
Determining the type and design of cathodic protection system	2-2	2-3
APPENDIX A SOIL RESISTIVITY MEASUREMENT		A-1
B CURRENT REQUIREMENT TESTING		B-1
C EXAMPLES OF GALVANIC CATHODIC PROTECTION DESIGN		C-1
D EXAMPLES OF IMPRESSED CURRENT CATHODIC PROTECTION DESIGN		D-1
E SPECIFICATIONS FOR CERAMIC ANODE		E-1
F RECTIFIER CURRENT INTERFERENCE		F-1
BIBLIOGRAPHY		BIBLIO-1
GLOSSARY		GLOSS-1

LIST OF FIGURES

<i>Figure</i>		<i>Page</i>
1-1	Corrosion of a pipeline due to localized anode and cathode sites	1-1
1-2.	Galvanic and impressed current systems for cathodic protection	1-2
2-1.	Design sequence for cathodic protection systems	2-3
A-1.	Wenner four-pin method for measuring resistivity	A-1
A-2.	Soil box for soil resistivity measurements	A-2
B-1.	Current requirement test on pipelines	B-1
C-1.	Galvanic anode cathodic protection for hydrant refueling system	C-1
C-2.	Galvanic anode cathodic protection for underground steel storage tank	C-4
C-5.	Layout of gas piping in residential district	C-5
D-1.	Cathodic protection system for gas main	D-1
D-2.	Impressed current cathodic protection for heating conduit system	D-4
D-3.	Cathodic protection for black iron hot water storage tank	D-7
D-4.	Fringe factor for stub anodes	D-9
D-5.	Dimensions for an elevated steel water tank	D-10
D-6.	Cathodic protection for tanks using rigid-mounted button-type anodes and platinized titanium wire	D-12
D-7.	Segmented elevated tank for area calculations	D-13
D-8.	Anode spacing for elevated steel water tank	D-15
D-9.	Anode suspension arrangement for elevated steel water tank	D-17
D-10.	Equivalent diameter factor for anodes in a circle in water tank	D-18

LIST OF FIGURES (CONT'd)

	<i>Paragraph</i>	<i>Page</i>
D-11.	Elevated steel water tank showing rectifier and anode arrangement	D-24
D-12.	Hand hole and anode suspension detail for elevated water tank	9-25
D-13.	Riser anode suspension detail for elevated water tank	9-25
E-1.	Ceramic anode specifications	E-1
F-1.	Structure-to-soil potential versus distance from foreign structure	F-1
F-2.	Cathodic interference testing	F-2

LIST OF TABLES

<i>Table</i>		<i>Page</i>
2-1.	Corrosivity of soils on steel based on soil resistivity	2-1
2-2.	Typical current density requirements for cathodic protection of uncoated steel	2-2
2-3.	Weights and dimensions of selected high-potential magnesium-alloy anodes	2-4
2-4.	Weights and dimensions of selected circular high-silicon chromium-bearing cast iron anodes	2-6
2-5.	Shape functions (K) for impressed current cathodic protection anodes where L is the effective anode length and d is the anode/backfill diameter	2-6
2-6.	Anode paralleling factors (P) for various numbers of anodes (N) installed in parallel	2-6
C-1.	Outside area of liquid fuel pipes	C-2
C-2.	Requirements for anode spacing	C-5
C-3.	Dimensions for finding outside area of pipe	C-6
C-4.	Galvanic anode size factor (If)	C-7
C-5.	Structure potential factor (y)	C-7
C-6.	Dimensions for finding anode division	C-8
D-1.	Dimensions for finding steam conduit area: heat distribution system	D-5
D-2.	Dimensions for finding condensate return conduit area: heat distribution system	D-5
D-3.	Conduit area: heat distribution system	D-6
D-4.	Anode division: heat distribution system	D-7
D-5.	Technical data: commonly used HSCBCI anodes	D-1

CHAPTER 1 INTRODUCTION TO CATHODIC PROTECTION

1-1. Purpose.

This manual presents design guidance for cathodic protection systems.

1-2. References.

a. Government publications.

Department of Transportation

Superintendent of Documents, U.S. Government Printing Office, Washington, DC 20402

Transportation of Natural and Other Gas by Pipeline: Minimum Federal Safety Standards, Subpart 1 - Requirements *Register*, Vol 36, No. 126 (June 30, 1971).

b. Nongovernment publications.

National Association of Corrosion Engineers (NACE), P.O. Box 218340, Houston, TX 77084

Standard RP-01-69 Control of External Corrosion on Underground or Submerged Metallic Piping Systems (1972 revision)

Standard RP-02-72 Direct Calculation of Economic Appraisals of Corrosion Control Measures

1-3. Corrosion.

Corrosion is an electrochemical process in which a current leaves a structure at the anode site, passes through an electrolyte, and reenters the structure at the cathode site as figure 1-1 shows. For example,

one small section of a pipeline may be anodic because it is in a soil with low resistivity compared to the rest of the line. Current would leave the pipeline at that anode site, pass through the soil, and reenter the pipeline at a cathode site. Current flows because of a potential difference between the anode and cathode. That is, the anode potential is more negative than the cathode potential, and this difference is the driving force for the corrosion current. The total system—anode, cathode, electrolyte, and metallic connection between anode and cathode (the pipeline in fig 1-1)—is termed a *corrosion cell*.

1-4. Cathodic protection.

Cathodic protection is a method to reduce corrosion by minimizing the difference in potential between anode and cathode. This is achieved by applying a current to the structure to be protected (such as a pipeline) from some outside source. When enough current is applied, the whole structure will be at one potential; thus, anode and cathode sites will not exist. Cathodic protection is commonly used on many types of structures, such as pipelines, underground storage tanks, locks, and ship hulls.

1-5. Types of cathodic protection systems.

There are two main types of cathodic protection systems: galvanic and impressed current. Figure 1-2 shows these two types. Note that both types have anodes (from which current flows into the

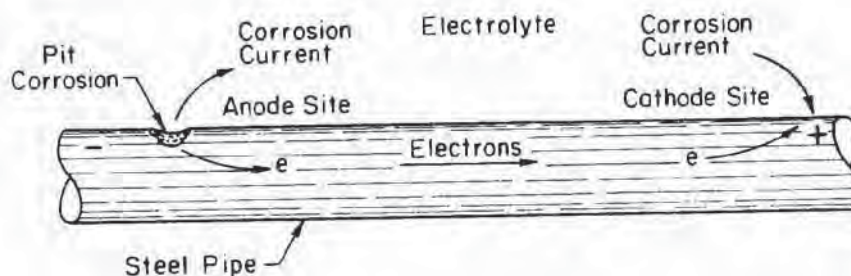

Reprinted from *Cathodic Protection*, L.M. Applegate, 1960, with permission of Mc Graw-Hill Book Company

Figure 1-1. Corrosion of a pipeline due to localized anode and cathode sites.

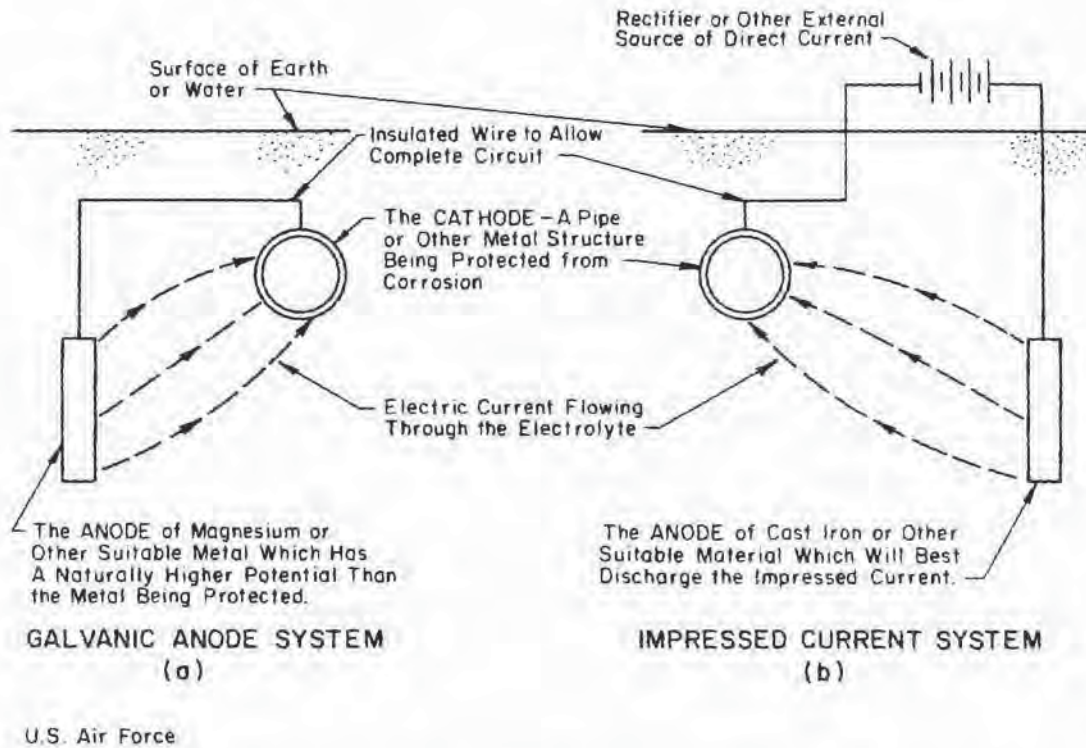

Figure 1-2. (a) Galvanic and (b) impressed current systems for cathodic protection.

electrolyte), a continuous electrolyte from the anode to the protected structure, and an external metallic connection (wire). These items are essential for all cathodic protection systems.

a. Galvanic system. A galvanic cathodic protection system makes use of the corrosive potentials for different metals. Without cathodic protection, one area of the structure exists at a more negative potential than another, and corrosion results. If, however, a much less inert object (that is, with much more negative potential, such as a magnesium anode) is placed adjacent to the structure to be protected, such as a pipeline, and a metallic connection (insulated wire) is installed between the object and the structure, the object will become the anode and the entire structure will become the cathode. That is, the new object corrodes sacrificially to protect the structure as shown in figure 1-2. Thus, the galvanic cathodic protection system is called a *sacrificial anode cathodic protection system* because the anode corrodes sacrificially to protect the structure. Galvanic anodes are usually made of either magnesium or

zinc because of these metals' higher potential compared to steel structures.

b. Impressed current systems. Impressed current cathodic protection systems use the same elements as the galvanic protection system, only the structure is protected by applying a current to it from an anode. The anode and the structure are connected by an insulated wire, as for the galvanic system. Current flows from the anode through the electrolyte onto the structure, just as in the galvanic system. The main difference between galvanic and impressed current systems is that the galvanic system relies on the difference in potential between the anode and structure, whereas the impressed current system uses an external power source to drive the current, as figure 1-2b shows. The external power source is usually a rectifier that changes input a.c. power to the proper d.c. power level. The rectifier can be adjusted, so that proper output can be maintained during the system's life. Impressed current cathodic protection system anodes typically are high-silicon cast iron or graphite.

CHAPTER 2

CATHODIC PROTECTION DESIGN

2-1. Required information.

Before deciding which type, galvanic or impressed current, cathodic protection system will be used and before the system is designed, certain preliminary data must be gathered.

a. Physical dimensions of structure to be protected. One important element in designing a cathodic protection system is the structure's physical dimensions (for example, length, width, height, and diameter). These data are used to calculate the surface area to be protected.

b. Drawing of structure to be protected. The installation drawings must include sizes, shapes, material type, and locations of parts of the structure to be protected.

c. Electrical isolation. If a structure is to be protected by the cathodic system, it must be electrically connected to the anode, as figure 1-2 shows. Sometimes parts of a structure or system are electrically isolated from each other by insulators. For example, in a gas pipeline distribution system, the inlet pipe to each building might contain an electric insulator to isolate inhouse piping from the pipeline. Also, an electrical insulator might be used at a valve along the pipeline to electrically isolate one section of the system from another. Since each electrically isolated part of a structure would need its own cathodic protection, the locations of these insulators must be determined.

d. Short circuits. All short circuits must be eliminated from existing and new cathodic protection systems. A short circuit can occur when one pipe system contacts another, causing interference with the cathodic protection system. When updating existing systems, eliminating short circuits would be a necessary first step.

e. Corrosion history of structures in the area. Studying the corrosion history in the area can prove very helpful when designing a cathodic protection system. The study should reinforce predictions for corrosivity of a given structure and its environment; in addition, it may reveal abnormal conditions not otherwise suspected. Facilities personnel can be a good source of information for corrosion history.

f. Electrolyte resistivity survey. A structure's corrosion rate is proportional to the electrolyte resistivity. Without cathodic protection, as electrolyte resistivity decreases, more current is allowed to flow from the structure into the electrolyte; thus, the structure corrodes more rapidly. As electrolyte

resistivity increases, the corrosion rate decreases (table 2-1). Resistivity can be measured either in a laboratory or at the site with the proper instruments. Appendix A explains the methods and equipment needed to complete a soil resistivity survey. The resistivity data will be used to calculate the sizes of anodes and rectifier required in designing the cathodic protection system.

Table 2-1. Corrosivity of soils on steel based on soil resistivity

Soil resistivity range (ohm-cm)	Corrosivity
0 to 2000	Severe
2000 to 10,000	Moderate to severe
10,000 to 30,000	Mild
Above 30,000	Not likely

U.S. Air Force.

g. Electrolyte pH survey. Corrosion is also proportional to electrolyte pH (see glossary for definition of pH and other terms). In general, steel's corrosion rate increases as pH decreases when soil resistivity remains constant.

h. Structure versus electrolyte potential survey. For existing structures, the potential between the structure and the electrolyte will give a direct indication of the corrosivity. According to NACE Standard No. RP-01, the potential requirement for cathodic protection is a negative (cathodic) potential of at least 0.85 volt as measured between the structure and a saturated copper-copper sulfate reference electrode in contact with the electrolyte. A potential which is less negative than -0.85 volt would probably be corrosive, with corrosivity increasing as the negative value decreases (becomes more positive).

i. Current requirement. A critical part of design calculations for cathodic protection systems on existing structures is the amount of current required per square foot (called *current density*) to change the structure's potential to -0.85 volt. The current density required to shift the potential indicates the structure's surface condition. A well coated structure (for example, a pipeline well coated with coal-tar epoxy) will require a very low current density (about 0.05 milliamperes per square foot); an uncoated structure would require high current density (about 10 milliamperes per square foot). The average current density required for cathodic protection is 2 milliamperes per square

TM 5-811-7

foot of bare area. The amount of current required for complete cathodic protection can be determined three ways:

—An actual test on existing structures using a temporary cathodic protection setup.

—A theoretical calculation based on coating efficiency.

—An estimate of current requirements using tables based on field experience.

(1) The second and third methods above can be used on both existing and new structures. Appendix B contains a detailed review of current requirement testing.

(2) Current requirements can be calculated based on coating efficiency and current density (current per square foot) desired. The efficiency of the coating as supplied will have a direct effect on the total current requirement, as equation 2-1 shows:

$$I = (A)(I_r)(1.0-CE), \tag{eq 2-1}$$

where I is total protective current, A is total structure surface area in square feet, I_r is required current density, and CE is coating efficiency. Equation 2-1 may be used when a current requirement test is not possible, as on new structures, or as a check of the current requirement test on existing structures. Coating efficiency is directly affected by the type of coating used and by quality control during coating application. The importance of coating efficiency is evident in the fact that a bare structure may require 100,000 times as much current as would the same structure if it were well coated.

(3) Current requirements also can be estimated from table 2-2. The table gives an estimate of current, in milliamperes per square foot, required for complete cathodic protection. That value, multiplied by the surface area of the structure to be protected (in square feet) gives the total estimated current required. Caution should be used when estimating, however, as under- or overprotection may result.

Table 2-2. Typical current density requirements for cathodic protection of uncoated steel

Environment	Current density (mA/sq ft)	
	AFM 88-9 ^a	Ger ^{rard} _b
Neutral soil	0.4 to 1.5	0.4 to 1.5
Well aerated neutral soil	2 to 3	2 to 3
Wetsoil	1 to 6	2.5 to 6
Highly acidic soil	3 to 15	5 to 15
Soil supporting active sulfate-reducing bacteria	6 to 42	Up to 42
Heated soil	3 to 25	5 to 25
Stationary freshwater	1 to 6	5
Moving freshwater containing dissolved oxygen	5 to 15	5 to 15
Seawater	3 to 10	5 to 25

^aData are from Air Force Manual AFM 88-9, *Corrosion Control* (U.S. Air Force, August 1962), chap 4, p 203.

^bData are from J.S. Gerrard, "Practical Applications of Cathodic Protection," *Corrosion*, Vol 2 (L.L. Shreir, Ed.), Newnes-Butterworths, London, 1976, p 11:65. Used with permission.

j. Coating resistance. A coating's resistance decreases greatly with age and directly affects structure-to-electrolyte resistance for design calculations. The coating manufacturers supply coating resistance values.

k. Protective current required. By knowing the physical dimensions of the structure to be protected, the surface area can be calculated. The product of the surface area multiplied by current density obtained previously in *I* above gives the total current required.

l. The need for cathodic protection. For existing structures, the current requirement survey (*I* above) will verify the need for a cathodic protection system. For new systems, standard practice is to assume a current density of at least 2 milliamperes per square foot of bare area will be needed to protect the structure. (However, local corrosion history may demand a different current density.) In addition, cathodic protection is *mandatory* for underground gas distribution lines (Department of Transportation regulations—Title 49, *Code of Federal Regulations*, Oct 1979) and for water storage tanks with a 250,000-gallon capacity or greater. Cathodic protection also is required for underground piping systems located within 10 feet

of steel reinforced concrete because galvanic corrosion will occur between the steel rebar and the pipeline.

2-2 Determining type and design of cathodic protection system.

When all preliminary data have been gathered and the protective current has been estimated, the design sequence can begin. The first question to ask is: which type (galvanic or impressed current) cathodic protection system is needed? Conditions at the site sometimes dictate the choice. However,

when this is not clear, the criterion used most widely is based on current density required and soil resistivity. If the soil resistivity is low (less than 5000 ohm-centimeters) and the current density requirement is low (less than 1 milliampere per square foot), a galvanic system can be used. However, if the soil resistivity and/or current density requirement exceed the above values, an impressed current system should be used. Figure 2-1 will be used in the design sequence. Design sequences for each type of cathodic protection system are given in paragraphs a and b below.

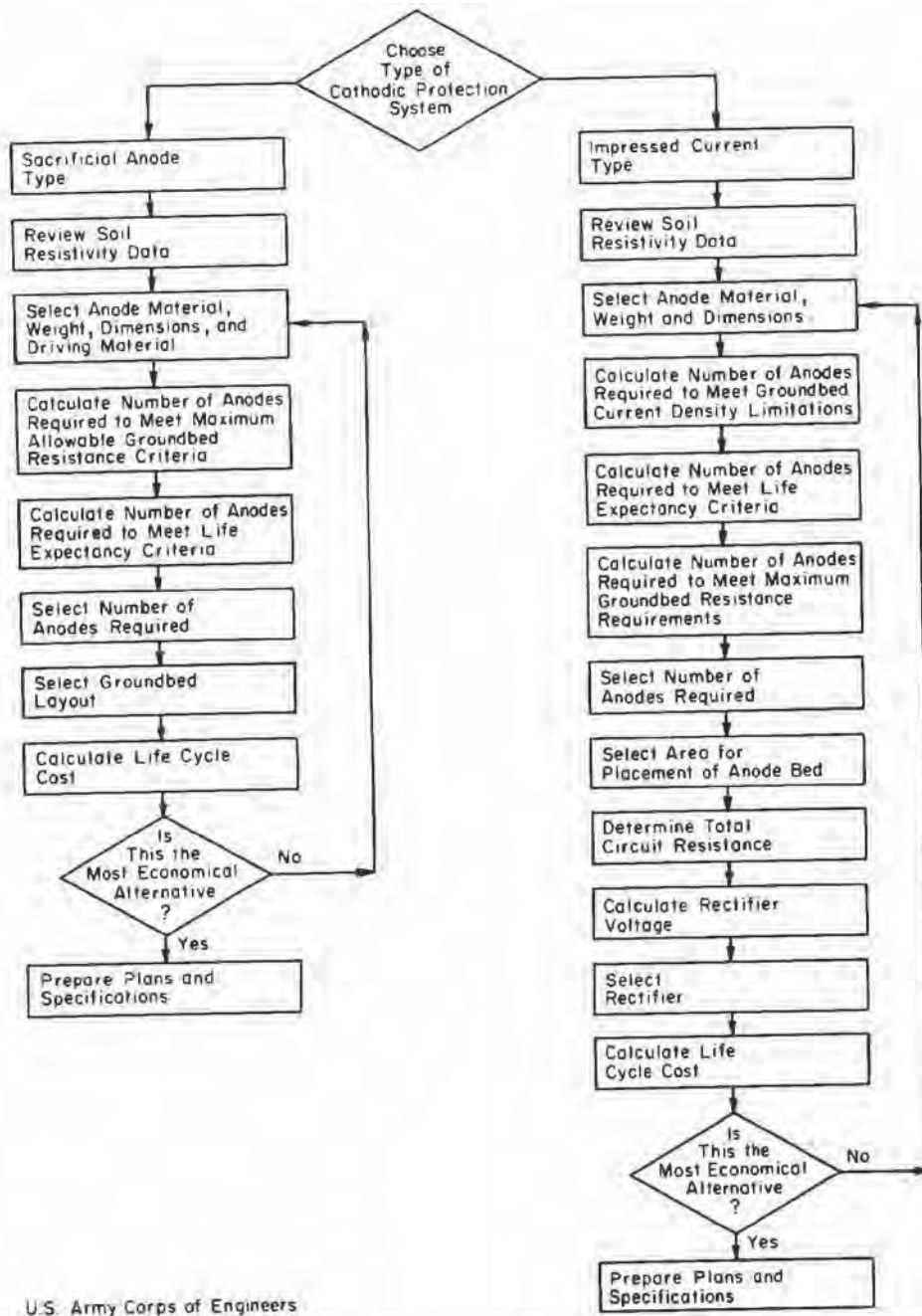

U.S. Army Corps of Engineers

Figure 2-1. Design sequence for cathodic protection systems.

a. *Sacrificial anode (galvanic) cathodic protection system design.* The following eight steps are required when designing galvanic cathodic protection systems. Appendix C gives examples of galvanic cathodic protection designs.

(1) Review soil resistivity. The site of lowest resistivity will likely be used for anode location to minimize anode-to-electrolyte resistivity. In addition, if resistivity variations are not significant, the average resistivity will be used for design calculations.

(2) Select anode. As indicated in paragraph 1-4, galvanic anodes are usually either magnesium or zinc. Zinc anodes are used in extremely corrosive soil (resistivity below 2000 ohm-centimeters). Data from commercially available anodes must be reviewed. Each anode specification will include anode weight, anode dimensions, and package dimensions (anode plus backfill), as table 2-3 shows for magnesium-alloy anodes. In addition, the anode's driving potential must be considered (para a[3] below). The choice of anode from those available is arbitrary; design calculations will be made for several available anodes, and the most economical one will be chosen.

Table 2-3. Weights and dimensions of selected high-potential magnesium-alloy anodes for use in soil or water

Weight (lb)	Size (in.)	Packaged wt (lb)	Packaged size (in.)
3	3.75 x 3.75 x 5	12	6 x 10
5	3.75 x 3.75 x 7.5	17	6 x 12
9	2.75 x 2.75 x 26	35	6 x 31
9	3.75 x 3.75 x 13.25	27	6 x 17
12	3.75 x 3.75 x 18	36	6 x 23
14	2.75 x 2.75 x 41	50	6 x 46
14	3.75 x 3.75 x 21	42	6.5 x 26
17	2.75 x 2.75 x 50	60	6 x 55
17	3.75 x 3.75 x 26	45	6.5 x 29
20	2.5 x 2.5 x 59.25	70	5 x 66
24	4.5 x 4.5 x 23	60	7 x 30
32	5.5 x 5.5 x 21	74	8 x 28
40	3.75 x 3.75 x 59.25	105	6.5 x 66
48	5.5 x 5.5 x 30	100	8 x 38
48	8 x 16	100	12 x 25
60	4.5 x 4.5 x 60	—	—

Note: Core material is a galvanized 20-gage perforated steel strip. Anodes longer than 24 inches have a 9-gage core. The connecting wire is a 10-foot length of solid No. 12 AWG TW insulated copper wire, silver-soldered to the core with joints sealed against moisture. Special wires or other lengths are available.

U.S. Air Force.

(3) Calculate net driving potential for anodes. The open-circuit potential of standard alloy

magnesium anodes is approximately -1.55 volts to a copper-copper sulfate half-cell. The open-circuit potential of high-manganese magnesium anodes is approximately -1.75 volts to a copper-copper sulfate half-cell.

(a) The potential of iron in contact with soil or water usually ranges around -0.55 volt relative to copper-copper sulfate. When cathodic protection is applied using magnesium anodes, the iron potential assumes some value between -0.55 and -1.0 volt, depending on the degree of protection provided. In highly corrosive soils or waters, the natural potential of iron may be as high as -0.82 volt relative to copper-copper sulfate. From this, it is evident that -0.55 volt should not be used to calculate the net driving potential available from magnesium anodes.

(b) A more practical approach is to consider iron polarized to -0.85 volt. On this basis, standard alloy magnesium anodes have a driving potential of 0.70 volt (1.55-0.85 0.70) and high-potential magnesium anodes have a driving potential of 0.90 volt (1.75-0.85 0.90). For cathodic protection design that involves magnesium anodes, these potentials, 0.70 and 0.90 volt, should be used, depending on the alloy selected.

(4) Calculate number of anodes needed to meet groundbed resistance limitations. The total resistance (RT) of the galvanic circuit is given by equation 2-2:

$$R_T = R_a + R_w + R_c, \tag{eq 2-2}$$

where R_a is the anode-to-electrolyte resistance, R_w is the anode lead wire resistance, and R_c is the structure-to-electrolyte resistance. The total resistance also can be found by using equation 2-3:

$$R_T \cdot \frac{\bullet E}{I}, \tag{eq 2-3}$$

where $\bullet E$ is the anode's driving potential discussed in a(3) above and I is the current density required to achieve cathodic protection (para 2-1). R_c in equation 2-2 can be calculated by using equation 2.4:

$$R_c \cdot \frac{R}{A}, \tag{eq 2-4}$$

where R is the average coating resistance, in ohms per square feet, at the end of the proposed lifetime for the system (R is specified by the supplier), and A is the structure's surface area in square feet. Assuming R_w in equation 2-2 is negligible, that anode-to-electrolyte resistance can then be calculated from equation 2-5:

$$R_a = R_T - R_c, \quad (\text{eq 2-5})$$

which gives the maximum allowable groundbed resistance; this will dictate the minimum number of anodes required (as number of anodes decreases, groundbed resistance increases). To calculate the number of anodes required, equation 2-6 is used:

$$N \cdot \frac{(0.0052)(\bullet)}{(R_a)(L)} \left[\ln \frac{8L}{d} \cdot 1 \right], \quad (\text{eq 2-6})$$

where N is the number of anodes, ρ is the soil resistivity in ohms, R_a is the maximum allowable groundbed resistance in ohms (as computed in eq 2-5), L is the length of the backfill column in feet (specified by supplier), and d is the diameter of the backfill column in feet (specified by supplier).

(5) Calculate number of anodes for system's life expectancy. Each cathodic protection system will be designed to protect a structure for a given number of years. To meet this lifetime requirement, the number of anodes (N) must be calculated using equation 2-7:

$$N \cdot \frac{(L)(I)}{49.3(W)}, \quad (\text{eq 2-7})$$

where L expected lifetime in years, W is weight (in pounds) of one anode, and I is the current density required to protect the structure (in milliamperes).

(6) Select number of anodes to be used. The greater value of equation 2-6 or 2-7 will be used as the number of anodes needed for the system.

(7) Select groundbed layout. When the required number of anodes has been calculated, the area to be protected by each anode is calculated by equation 2-8:

$$A \cdot \frac{A_T}{N}, \quad (\text{eq 2-8})$$

where A is area to be protected by one anode, A_T is total surface area to be protected, and N is the total number of anodes to be used. For galvanic cathodic protection systems, the anodes should be spaced equally along the structure to be protected.

(8) Calculate life-cycle cost for proposed design. NACE Standard RP-02 should be used to calculate the system's life-cycle cost. The design process should be done for several different anode

choices to find the one with minimal life-cycle cost.

(9) Prepare plans and specifications. When the design procedure has been done for several different anodes and the final anode has been chosen, plans and specifications can be completed.

b. Impressed current cathodic protection system design. Thirteen steps are required when designing impressed current cathodic protection systems. Appendix D gives examples of impressed current cathodic protection designs.

(1) Review soil resistivity. As with galvanic systems, this information will contribute to both design calculations and location of anode groundbed.

(2) Review current requirement test. The required current will be used throughout the design calculations. The calculated current required to protect 1 square foot of bare pipe should agree with the values in table 2-2.

(3) Select anode. As with the galvanic system, the choice of anode is arbitrary at this time; economy will determine which anode is best. Table 2-4 gives common anode sizes and specifications. The anodes used most often are made of high-silicon chromium-bearing cast-iron (HSCBCI). When impressed current-type cathodic protection systems are used to mitigate corrosion on an underground steel structure, the auxiliary anodes often are surrounded by a carbonaceous backfill. Backfill materials commonly used include coal coke breeze, calcined petroleum coke breeze, and natural graphite particles. The backfill serves three basic functions: (a) it decreases the anode-to-earth resistance by increasing the anode's effective size, (b) it extends the system's operational life by providing additional anode material, and (c) it provides a uniform environment around the anode, minimizing deleterious localized attack. The carbonaceous backfill, however, cannot be expected to increase the groundbed life expectancy unless it is well compacted around the anodes. In addition to HSCBCI anodes, the ceramic anode should be considered as a possible alternative for long-term cathodic protection of water storage tanks and underground pipes in soils with resistivities less than 5000 ohm-centimeters. The ceramic anode consumption rate is 0.0035 ounce per ampere-year compared to 1 pound per ampere-year for HSCBCI anodes. Appendix E gives the design and specifications for the ceramic anode.

Table 2-4. Weights and dimensions of selected circular high-silicon chromium-bearing cast iron anodes

Anode weight (lb)	Anode dimensions (in.)	Anode surface size (in.)	Package area (sq ft)
12	1 x 60	1.4	10 x 84
44	2 x 60	2.6	10 x 84
60	2 x 60	2.8	10 x 84
110	3 x 60	4.0	10 x 84

Reproduced from Harco Corporation, *Catalog of Cathodic Protection Materials*, 1971. Used with permission.

(4) Calculate number of anodes needed to satisfy manufacturer's current density limitations. Impressed current anodes are supplied with a recommended maximum current density. Higher current densities will reduce anode life. To determine the number of anodes needed to meet the current density limitations, use equation 2-9:

$$N \cdot \frac{I}{(A_1)(I_1)}, \quad (\text{eq 2-9})$$

where N is number of anodes required, I is total protection current in milliamperes, A₁ is anode surface area in square feet per anode, and I₁ is recommended maximum current density output in milliamperes.

(5) Calculate number of anodes needed to meet design life requirement. Equation 2-10 is used to find the number of anodes:

$$N \cdot \frac{(L)(I)}{(1000)(W)}, \quad (\text{eq 2-10})$$

where N is number of anodes, L is life in years, and W is weight of one anode in pounds.

(6) Calculate number of anodes needed to meet maximum anode groundbed resistance requirements. Equation 2-11 is used to calculate the number of anodes required:

$$R_a \cdot \frac{\bullet K}{NL} \cdot \frac{\bullet P}{S}, \quad (\text{eq 2-11})$$

where R_a is the anodes' resistance, • is soil resistivity in ohm-centimeters, K is the anode shape factor from table 2-5, N is the number of anodes, L is length of the anode backfill column in feet, P is the paralleling factor from table 2-6, and S is the center-to-center spacing between anode backfill columns in feet.

Table 2-5. Shape functions (K) for impressed current cathodic protection anodes where L is effective anode length and d is anode/backfill diameter.

L/d	K	L/d	K
5	0.0140	20	0.0213
6	0.0150	25	0.0224
7	0.0158	30	0.0234
8	0.0165	35	0.0242
9	0.0171	40	0.0249
10	0.0177	45	0.0255
12	0.0186	.50	0.0261
14	0.0194	55	0.0266
16	0.0201	60	0.0270
28	0.0207		

Reproduced from W.T. Bryan, *Designing Impressed Current Cathodic Protection Systems With Durco Anodes*, The Duriron Company, 1970. Used with permission.

Table 2-6. Anode paralleling factors (F) for various numbers of anodes (N) installed in parallel

N	P	N	P
2	0.00261	14	0.00168
3	0.00289	16	0.00155
4	0.00283	18	0.00145
5	0.00268	20	0.00135
6	0.00252	22	0.00128
7	0.00237	24	0.00121
8	0.00224	26	0.00114
9	0.00212	28	0.00109
10	0.00201	30	0.00104
12	0.00182		

Reproduced from W.T. Bryan, *Designing Impressed Current Cathodic Protection Systems With Durco Anodes*, The Duriron Company, 1970. Used with permission.

(7) Select number of anodes to be used. The highest number calculated by equation 2-9, 2-10, or 2-11 will be the number of anodes used.

(8) Select area for placement of anode bed. The area with the lowest soil resistivity will be chosen to minimize anode-to-electrolyte resistance.

(9) Determine total circuit resistance. The total circuit resistance will be used to calculate the rectifier size needed.

(a) Calculate anode groundbed resistance. Use equation 2-11.

(b) Calculate groundbed header cable resistance. The cable is typically supplied with a specified resistance in ohms per 100 feet. The wire resistance then is calculated from equation 2-12:

$$R_w \cdot \frac{\text{ohms (L)}}{100 \text{ ft}}, \quad (\text{eq 2-12})$$

where L is the structure's length in feet. Economics are important in choosing a cable, and may indeed be the controlling factor. To determine the total annual cable cost, Kelvin's Economic Law can be used as shown in equation 2-13.

$$T \cdot \frac{(0.0876)(I^2)(R)(L)(P)}{E} \cdot (0.15)(S)(L), \quad (\text{eq 2-13})$$

where T is total annual cost in dollars per year, I is total protection current in amperes, R is cable resistance in ohms per 1000 feet, L is cable length in feet, P is cost of electrical energy in farads per kilowatt-hour, E is the rectifier efficiency expressed as percent, and S is the cable's initial cost in dollars per foot.

(c) Calculate structure-to-electrolyte resistance using equation 2-14:

$$R_c \cdot \frac{R}{N}, \quad (\text{eq 2-14})$$

where R_c is the structure-to-electrolyte resistance, R is the coating resistance in ohms per square feet, and N is the coated pipe area in square feet.

(d) Calculate total circuit resistance. To calculate the total resistance, R_T , equation 2-15 is used:

$$R_T \cdot R_a \cdot R_w \cdot R_c, \quad (\text{eq 2-15})$$

where variables are the same as for equations 2-11, 242, and 2-14.

(10) Calculate rectifier voltage. Equation 2-16 is used to determine voltage output (V_{rec}) of the rectifier:

$$V_{rec} \cdot (I)(R_T)(150\%), \quad (\text{eq 2-16})$$

where I is total protection current in amperes, R_T is total circuit resistance, and 150 percent is a factor to allow for aging of the rectifier stacks.

(11) Select a rectifier. A rectifier must be chosen based on the results of equation 2-16. Many rectifiers are available commercially; one that satisfies the minimum requirements of (I) and (V_{rec}) in equation 2-16 should be chosen. Besides the more common rectifiers being marketed, a solar cathodic protection power supply (for d.c. power) may be considered for remote sites with no electrical power. Three factors that should be considered when specifying a solar cathodic protection power supply are:

—The cost of the solar cathodic protection power supply in dollars per watt of continuous power.

—The solar cathodic protection power supply's much higher initial cost compared to selenium rectifiers operated by a.c. power.

—The additional maintenance required for a solar cathodic protection power supply, mainly to keep the solar panels free of dirt deposits. Appendix F discusses rectifier current interference.

(12) Calculate system cost. As with the galvanic cathodic protection system, the choice of anode for design calculation is arbitrary. When several anodes have been used in the design calculations, an economic analysis should be done as recommended in NACE Standard RP-02.

(13) Prepare plans and specifications.

APPENDIX A SOIL RESISTIVITY MEASUREMENT

A-1. Introduction.

Since soil resistivity is a major factor affecting the corrosion rate, the design engineer should know how to measure it. Generally, as soil resistivity decreases, corrosivity increases. In addition, as soil moisture content increases, resistivity decreases. Soil resistivity typically is measured using one or both of two methods: (1) testing onsite with the Wenner four-pin method, and/or (2) taking a soil sample to a laboratory for a soil box resistivity test. It must be stressed that soil resistivity may vary widely within very short distances. Soil resistivity also changes with depth below the ground surface. Thus, if the soil sample method is used, many samples must be taken for an accurate map of soil resistivities in the area. The soil box resistivity test also is much more time-consuming than the four-pin method.

A-2. Wenner four-pin method.

As figure A-1 shows, this method is done by placing four pins at equal distances from each other. A current is then sent through the two outer pins. By measuring the voltage across the two inner pins, the soil resistance can be calculated using Ohm's Law (V/IR). Soil resistivity can be determined using equation A-1:

$$\text{Resistivity} = 191.5 RL \text{ ohm-cm}, \quad (\text{eq A-1})$$

where R is the resistance found above and L is the pin spacing in feet. Buried utilities may produce interference when using the Wenner method in congested areas. Therefore, it is important to position the pins perpendicular to the underground pipeline. Placing pins parallel to the pipeline would result in measurements lower than actual resistivity.

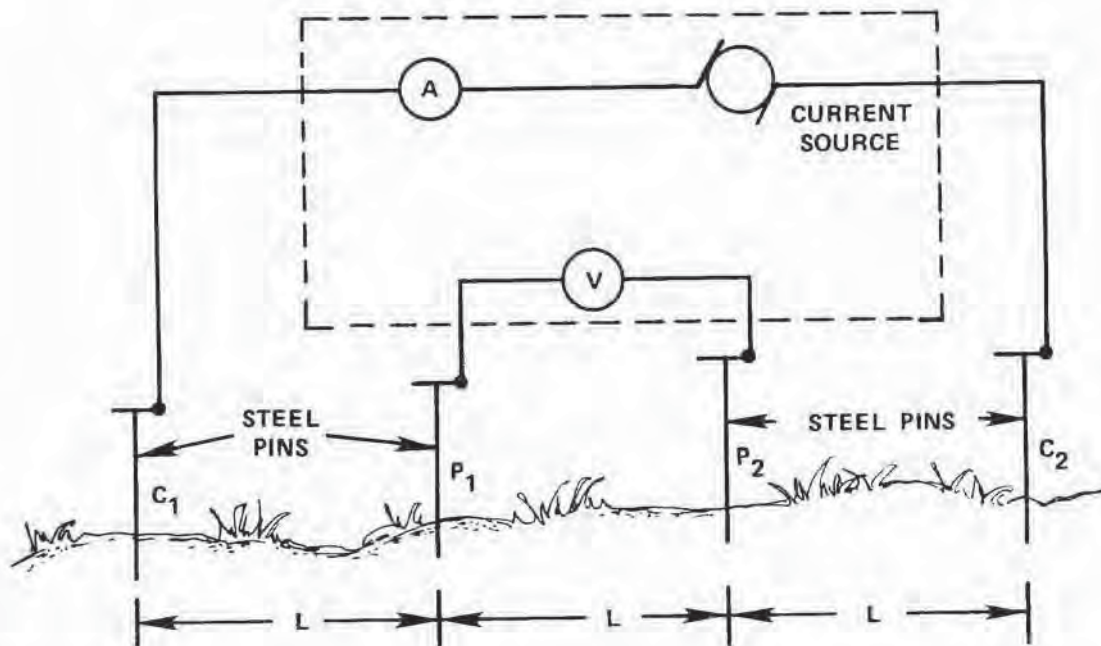

Reprinted from NACE Basic Corrosion Course, 11th Printing, with permission of the National Association of Corrosion Engineers.

Figure A-1. Wenner four-pin method for measuring soil resistivity.

TM 5-811-7

A-3. Soil box method.

This resistivity test works on the same principle as the Wenner four-pin test. That is, there are four points of electrical contact with the soil; the current is driven through the two outer points and the voltage drop is measured across the two inner points. In the soil box, however, the outer "points" are the metal end plates of the box, rather than pins. The inner points are pins, just as in the Wenner four-pin method. Figure A-2 gives details of the soil box. Again, for resistance, $R=VI$ from Ohm's Law, but resistivity is now calculated by equation A-2:

$$\text{Resistivity} \cdot R = \frac{WD}{L}, \quad (\text{eq A-2})$$

where W, D, and L are the soil box dimensions (fig A-2).

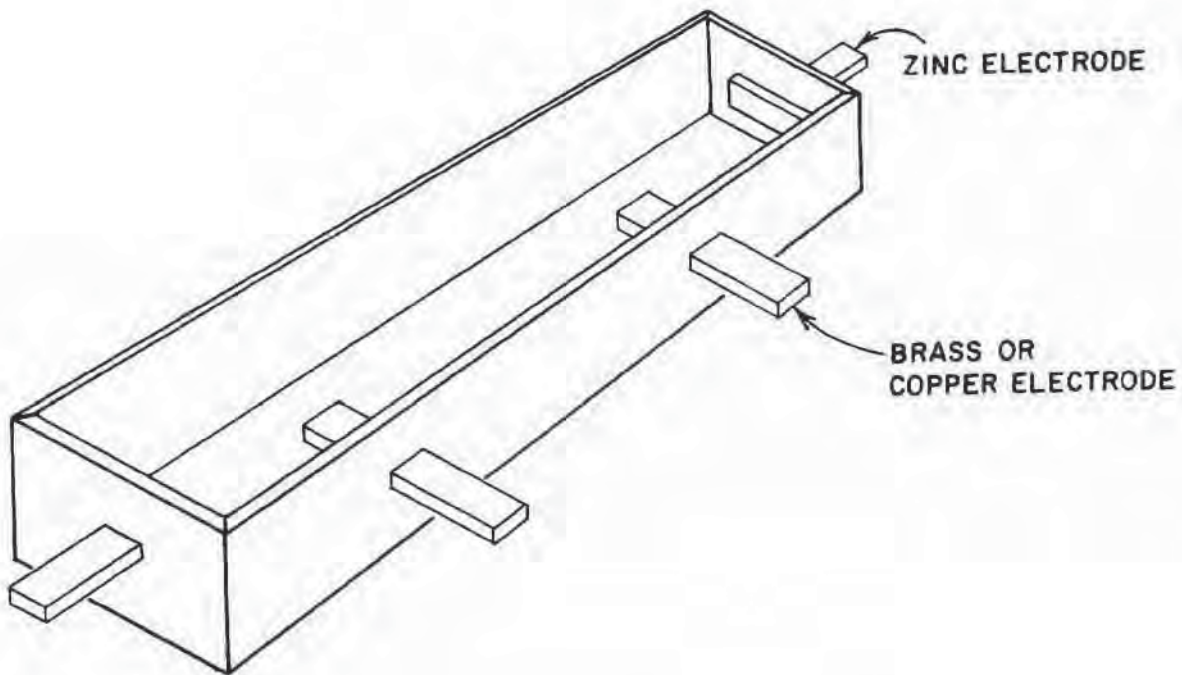

U.S. Air Force

Figure A-2. Soil box for soil resistivity measurements.

A-4. Temperature effect.

Temperature greatly affects soil resistivity at temperatures below freezing. Thus, soil resistivity should not be measured on soil at below-freezing temperatures.

APPENDIX B CURRENT REQUIREMENT TESTING

B-1. Required current.

A critical element in designing galvanic and impressed current cathodic protection systems is the current required for complete cathodic protection. Complete cathodic protection is achieved when the structure potential is -0.85 volt with respect to a copper-copper sulfate reference electrode.

B-2. Sample test.

Current requirement tests are done by actually applying a current using a temporary test setup, and adjusting the current from the power source until suitable protective potentials are obtained. Figure B-1 shows a temporary test setup. In this setup, batteries can be used as the power supply, in series with heavy-duty adjustable resistors. The resistors can be adjusted to increase the current until the potential at the location of interest, such as point A in figure B-1, is at -0.85 volt with respect to a copper-copper sulfate reference cell. The current supplied is the current required for cathodic protection. The effectiveness of the insulating joints shown in figure B-1 can also be tested. The potentials at points B and C are measured, first with the current interruptor switch closed, then with it open. If there is any difference between the two readings at either point, the joint is not insulating completely.

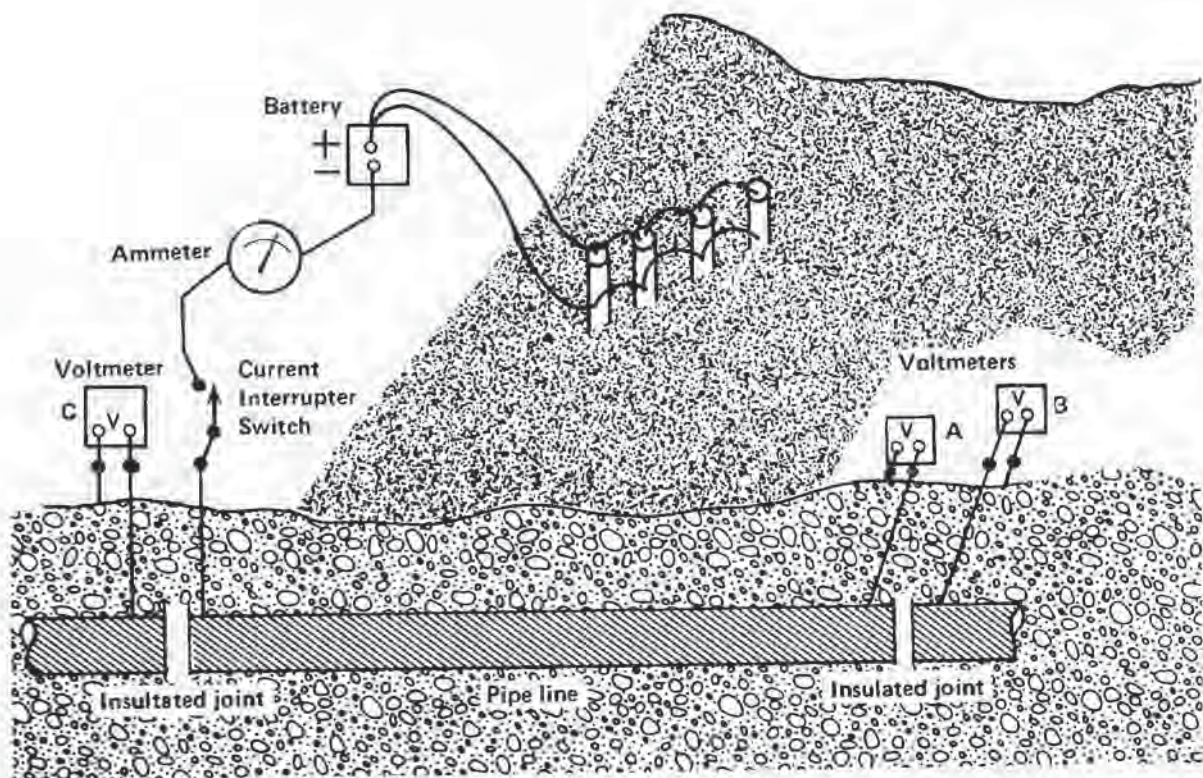

U.S. Army Corps of Engineers

Figure B-1. Current requirement test on pipeline

APPENDIX C EXAMPLES OF GALVANIC CATHODIC PROTECTION DESIGN

C-1. Purpose.

The examples that follow show how to use the design procedure explained in paragraphs 2-1 and 2-2.

C-2. Aircraft multiple hydrant refueling system.

Galvanic cathodic protection is designed for a standard aircraft hydrant refueling system as shown in figure C-1. This design is for a system not yet installed.

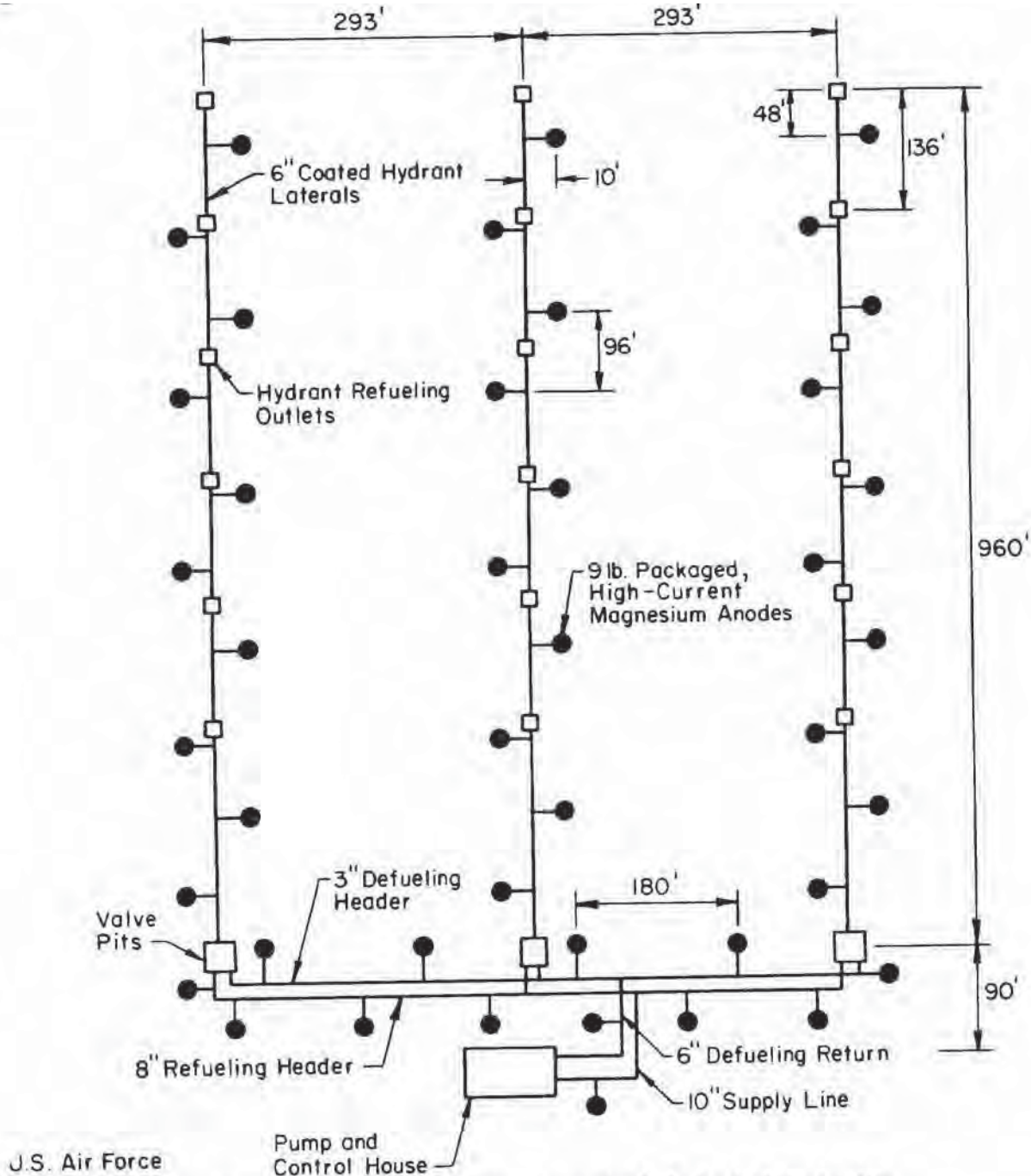

Figure C-1. Galvanic anode cathodic protection for hydrant refueling system.

J.S. Air Force

TM 5-811-7

a. Design data.

- (1) Average soil resistivity is 5000 ohm-centimeters.
- (2) Effective coating resistance at 25 years will be 2500 ohms per square foot, as suggested by the manufacturer.
- (3) Design for 90 percent coating efficiency, based on experience.
- (4) Design for 25-year life.
- (5) Design for 1 milliampere per square foot of bare pipe after polarization (corrosion history of area indicates this value is adequate).
- (6) Magnesium packaged-type anodes must be used (soil resistivity is greater than 2000 ohm-centimeters).
- (7) System is insulated well enough from foreign structures.
- (8) All piping is mill-coated with hot-applied coal-tar enamel and wrapped with asbestos felt. Coating has been tested over the trench for holidays and defects have been corrected. Coating is assumed better than 99.5 percent perfect at installation.

b. Computations (fig C-1).

- (1) Find the total outside area of liquid fuel pipes serving the hydrant refueling area (table C-1).

Table C-1. Outside area of liquid fuel pipes

Pipe size (in.)	Pipe length (ft)	Pipe area (sq ft/ft)
3 (defueling header)	2 x 293 = 586	586 x 0.916 = 537
6 (defueling return)	90	90 x 1.734 = 156
8 (refueling header)	2 293 = 586	586 x 2.258 = 1323
10 (supply line)	90	90 x 2.82 = 254
6 (hydrant laterals)	3 x 960 = 2880	2880 x 1.734 = 4994
Total area of POL pipe in square feet		=7264

Reproduced from J.R. Myers and M.A. Aimone, *Corrosion Control for Underground Steel Pipelines: A Treatise on Cathodic Protection*, J.R. Myers and Associates, Franklin, OH. Used with permission.

(2) Some experience has shown that steel in this type soil can be cathodically protected with approximately 1 milliampere per square foot of uncoated surface. Thus, find the required current based on this value and using equation 2-1:

$$\begin{aligned}
 I &= (A)(I')(1.0 - CE) \\
 &= (7264 \text{ sq ft})(1.0 \text{ mA/sq ft})(1.0 - 0.8) \\
 &= 726 \text{ mA.}
 \end{aligned}$$

(3) Calculate the number of anodes needed based on maximum groundbed resistance limitations.

(a) Select a 9-pound anode, 3.5 by 3.5 by 13 inches, from table 2.4. Driving potential as provided by the manufacturer is 0.9 volt.

(b) Calculate total circuit resistance using equation 2-3:

$$\begin{aligned}
 R_T &\cdot \frac{E}{I}, \\
 R_T &\cdot \frac{0.9}{0.726} \times 1.23 \text{ ohms.}
 \end{aligned}$$

(c) Calculate structure-to-electrolyte resistance from equation 2-4:

$$R_c \cdot \frac{R}{N}$$

$$R_c \cdot \frac{2500 \text{ ohms/sq ft}}{7264 \text{ sq ft}}$$

$$R_c \cdot 0.345 \text{ ohm.}$$

(d) Find maximum allowable groundbed resistance using equation 2-2:

$$R_T \cdot R_a \cdot R_w \cdot R_c$$

$$1.23 \text{ ohm} = R_a + 0.345 \text{ ohm (assume } R_w \text{ is negligible)}$$

$$0.89 \text{ ohm} = R_a$$

(e) Calculate number of anodes from equation 2-6:

$$N \cdot \frac{(0.0052)(\bullet)}{(R_a)(L)} \left[\ln \frac{8L}{d} \cdot 1 \right],$$

$$N \cdot \frac{(0.0052)(500 \text{ ohm} \cdot \text{cm})}{(0.89 \text{ ohm})(1.42 \text{ ft})} \left[\ln \frac{(8)(1.42 \text{ ft})}{(0.5 \text{ ft})} \cdot 1 \right]$$

(values for L and D from supplier.)

$$N = 44 \text{ anodes.}$$

(4) Calculate number of anodes based on system's life expectancy and using equation 2-7:

$$N \cdot \frac{(L)(I)}{49.3 \text{ (W)}}$$

$$N \cdot \frac{(25 \text{ yr})(726 \text{ mA})}{49.3 \text{ (9 lb/anode)}}$$

$$N = 41 \text{ anodes.}$$

(5) Select number of anodes. Since 44 anodes are required to meet maximum allowable groundbed resistance (e above), that will be the number used.

(6) Select groundbed layout. Determine the area to be covered by each anode using equation 2-8:

$$A \cdot \frac{A_T}{N}$$

$$A \cdot \frac{7264 \text{ sq ft}}{44 \text{ anodes}}$$

$$A = 164 \text{ sq/ft anode.}$$

(7) Find anode spacing (table C-2).

Table C-2. Requirements for anode spacing

Pipe section	Pipe area (sq ft)	Number of anodes	Pipe length (ft)	Anode spacing (ft)
Laterals	4994	30	2880	96
Headers	1860	12	1172	98
Supply and return lines	410	2	180	90

Reproduced from J.R. Myers and MA. Aimone, *Corrosion Control for Underground Steel Pipelines: A Treatise on Cathodic Protection*. J.R. Myers and Associates, Franklin, OH. Used with permission.

TM 5-811-7

(8) Calculate life-cycle cost as recommended in paragraph 2-2. Comparisons with other anode sizes and types will yield the most economical design.

c. *Placement.* Locate anodes as shown in figure C-1.

C-3. Alternative calculations.

The design examples in paragraphs C-4 and C-5 below use calculations that differ from those used in the text and in paragraph C-2. Exposure to different methods of calculation should help the design engineer to better understand the design procedure.

C-4. Underground steel storage tank.

Galvanic cathodic protection is designed for an underground steel storage tank shown in figure C-2. The tank is already installed and current requirement tests have been made.

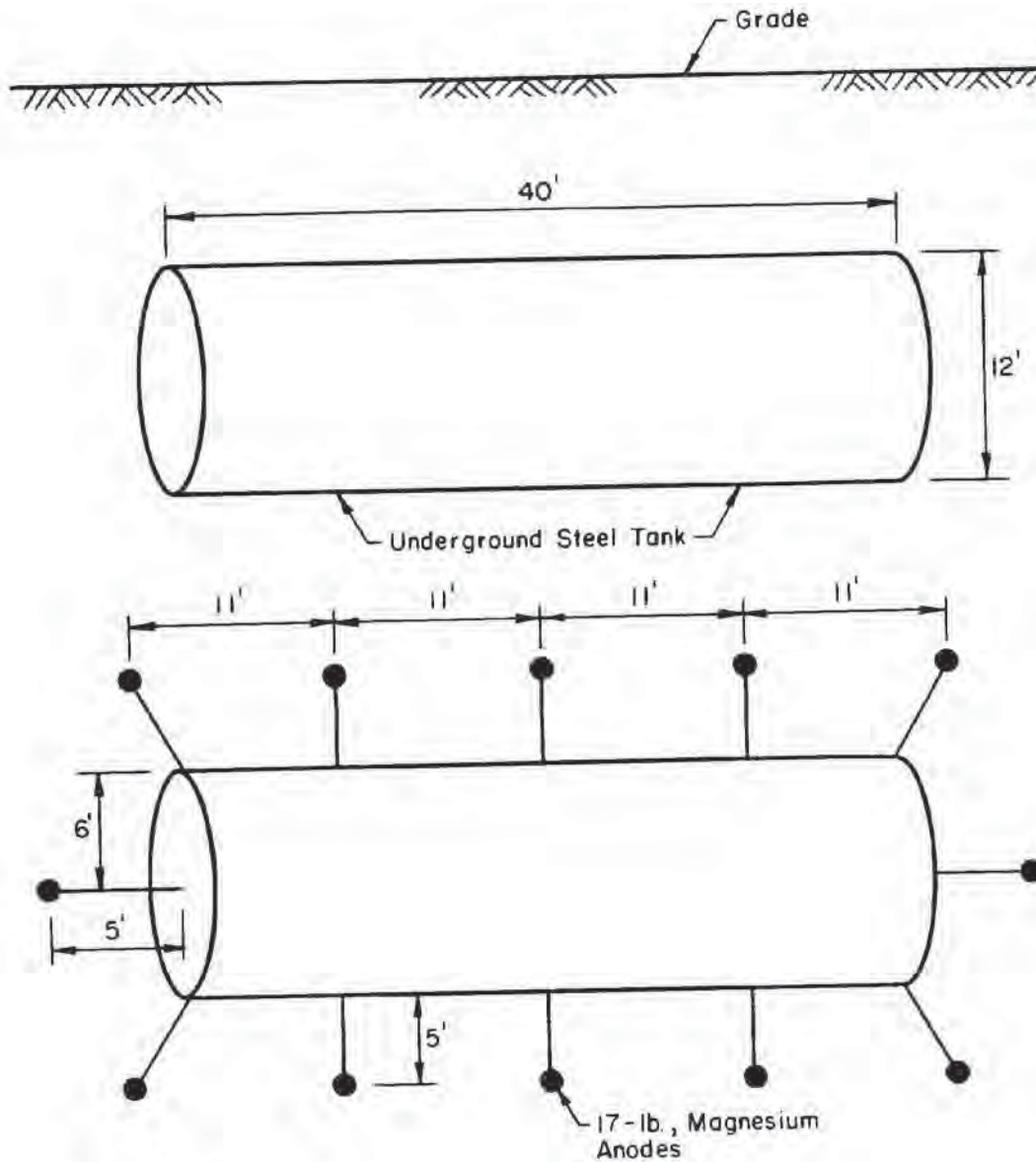

U.S. Air Force

Figure C-2. Galvanic anode cathodic protection for underground steel storage tank.

a. Design data.

- (1) Tank diameter is 12 feet.
- (2) Tank length is 40 feet.
- (3) Design for 80 percent coating efficiency, based on experience.
- (4) Design for 15-year life.
- (5) Current requirement is 0.7 ampere.
- (6) Packaged 17-pound standard magnesium anodes must be used.
- (7) The tank is insulated well enough from foreign structures.

b. Computations.

- (1) Find the minimum weight of anodes required for the tank using equation C-1:

$$W = \frac{YSI}{E}, \tag{eq C-1}$$

where Y = 15 years, S = 8.8 pounds per ampere-year, I = 0.7 ampere, and E = 0.50 efficiency. Thus,

$$W = \frac{(15 \text{ yr})(8.8 \text{ lb/A} \cdot \text{yr})(0.7 \text{ A})}{0.50},$$

W = 184.8 lb.

- (2) Find the number of magnesium anodes (17 pounds each) required:

$$N = \frac{184.8}{17} \cdot 10.9 \text{ (use 12 anodes for symmetry).}$$

- c. Placement. Locate anodes as shown in figure C-2.

C-5. Gas distribution system.

Galvanic cathodic protection is designed for a gas distribution system in a housing area as shown in figure C-3.

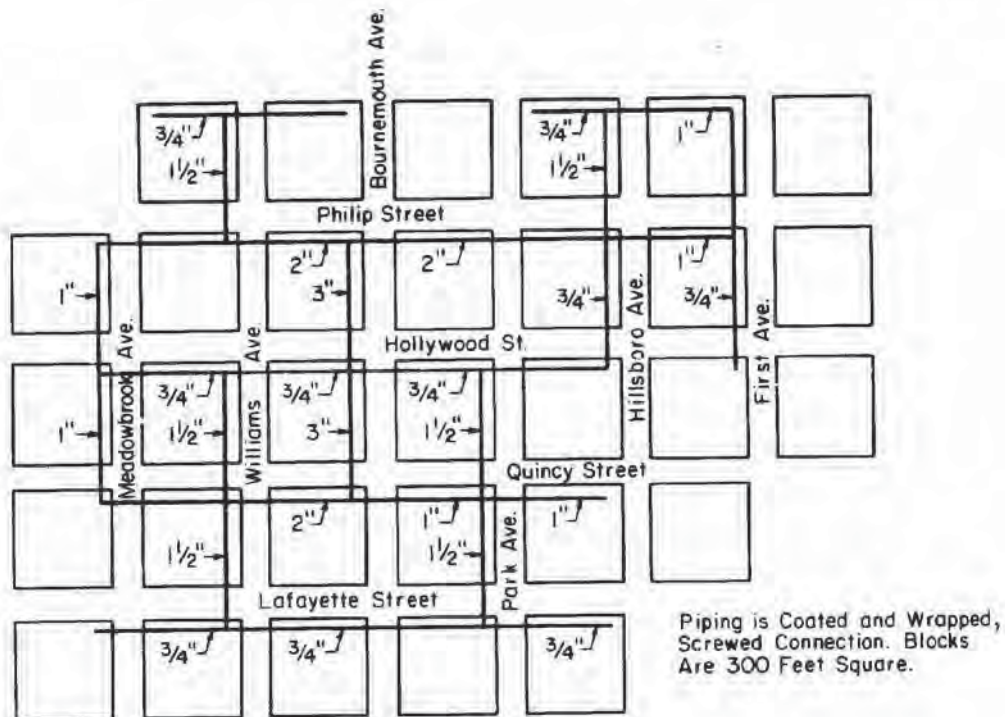

U.S. Air Force

Figure C-3. Layout of gas piping in residential district.

TM 5-811-7

a. Design data.

- (1) Average soil resistivity is 4500 ohm-centimeters.
- (2) Design for 90 percent coating efficiency, based on experience.
- (3) Design for 15-year life.
- (4) Design for 2 milliamperes per square foot of bare pipe.
- (5) Packaged-type magnesium anodes must be used.
- (6) Insulating couplings are used on all service taps. Mains are electrically isolated from all other metal structures in the area.
- (7) All pipe has been precoated at the factory and wrapped with asbestos felt. The coating has been tested over the trench for holidays and defects have been corrected. The coating is considered to be better than 99.5 percent perfect when installed.

b. Computations.

- (1) Find the total outside area of piping (table C-3).
- (2) Find the area of bare pipe to be protected cathodically based on 90 percent coating efficiency:

$$A = 4288 \times 0.1$$

$$A = 429 \text{ sq. ft.}$$

- (3) Find the maximum protective current required based on 2 milliamperes per square foot of bare metal:

$$I = 2 \times 429$$

$$I = 858 \text{ mA or } 0.858 \text{ A.}$$

Table C-3. Dimensions for finding outside area of pipe

Pipe size (in.)	Pipe length (ft)	Pipe area (sq ft/lin ft)	Pipe area (sq ft)
3	600	0.916	550
2	1500	0.622	933
1½	1800	0.497	894
1	2400	0.344	826
	3900	0.278	<u>1084</u>
Total area of pipe in square feet			4288

U.S. Air Force.

- (4) Find the weight of anode material required based on maximum current requirement and 15-year life. Use equation C-1:

$$W = \frac{YSI}{E},$$

where Y = 15 years, S = 8.8 pounds per ampere-year, I = 0.858 ampere, and E = 0.50 efficiency. Thus,

$$W = \frac{(15 \text{ yr})(8.8 \text{ lb/A} \cdot \text{yr})(0.858 \text{ A})}{0.50},$$

$$W = 227 \text{ lb.}$$

Note that the 227-pound value is based on an output current of 0.86 ampere for the cathodic protection system's full design life, 15 years. Strictly speaking, this is not the true condition, because current output after new installation is much less due to the high coating efficiency. The average current requirement at first may be as low as 0.03 milliamperes per square foot of pipe.

(5) Find the current output to ground for a single 17-pound standard packaged magnesium anode using equation C-2:

$$i \cdot \frac{Cfy}{P}, \tag{eq C-2}$$

where C = 120,000, a constant for well coated structures using magnesium, f = 1.00 (table C-4), y = 1.00 (table C-5), P = 4500 ohm-centimeters. Thus,

$$i \cdot \frac{120,000 \times 1.00 \times 1.00}{4500 \text{ ohm} \cdot \text{cm}}$$

$$i = 26.7 \text{ mA.}$$

Because the structure is well coated, anode spacing will be relatively large.

Table C-4. Galvanic anode size factor (f)

Anode weight	Standard anodes	Size factor (f)
3	(packaged)	0.53
5	(packaged)	0.60
9	(packaged)	0.71
17	(packaged)	1.00
32	(packaged)	1.06
50	(packaged-anode dimension 8" dia x 16") ^a	1.09
50	(packaged-anode dimension 5" x 5" x 31")	1.29
Long anodes		
9	(2.75" x 2.75" x 26" backfill 6" x 31")	1.01
10	(1.5" x 1.5" x 72" backfill 4" x 78")	1.71
18	(2" x 2" x 72" backfill 5" x 78")	1.81
20	(2.5" x 2.5" x "60" backfill 5" x 66")	1.60
40	(3.75" x 3.75" x 60" backfill 6.5" x 66")	1.72
42	(3" x 3" x 72" backfill 6" x 78")	1.90
Extra-long anodes		
15	(1.6" dia x 10• backfilled to 6" din)	2.61
20	(1.3" x 20• backfilled to 6" din)	4.28
25	(2" dia x 10• backfilled to 8" din)	2.81

^aIn this table, "denotes inches, ' denotes feet.

Reprinted from DA. Tefankjian, "Application of Cathodic Protection," *Materials Protection and Performance*. Vol 11 (No. 11), November 1972. Used with permission.

Table C-5. Structure potential factor (y)

Structure-to-electrolyte potential (volts, relative to copper-copper sulfate)	Magnesium structure factor (y)	Zinc structure factor (y)
-0.70	1.14	1.60
-0.80	1.07	1.20
-0.85	1.00	1.00
-0.90	0.93	0.80
-1.00	0.79	0.40
-1.10	0.64	0.00
-1.20	0.50	0.00

Reprinted from I.A. Tefankjian, "Application of Cathodic Protection." *Materials Protection and Performance*. Vol 11 (No. 11), November 1972. Used with permission.

TM 5-811-7

(6) Find the number of anodes (n) required from equation C-3:

$$n \cdot \frac{I}{i}, \tag{eq C-3}$$

where I = 858 milliamperes and i = 26.7 milliamperes. Thus,

$$n \cdot \frac{858}{26.7}$$

n = 32.1 (use 32 anodes).

(7) Find the anode distribution.

(a) Pipe area protected by one anode:

$$A = 4288/32$$

A = 134 sq ft/anode.

(b) Find the anode division (table C-6).

Table C-6. Dimensions for finding anode division

Pipe size (in.)	Pipe area (sq ft)	Pipe length (ft)	Number of anodes	Anode spacing (ft)
3	550	600	4	150
2	933	1500	7	214
1½	895	1800	7	257
1	826	2400	6	400
¾	1084	2900	<u>8</u>	488
Total number of anodes			32	

U.S. Air Force.

APPENDIX D

EXAMPLES OF IMPRESSED CURRENT CATHODIC PROTECTION DESIGN

D-1. Purpose.

The example in paragraph D-2 below shows how to use the design procedure explained in paragraphs 2-1 and 2-2. Examples in paragraphs D-3 through D-6 are for alternative calculation methods.

D-2. Steel gas main.

Impressed current cathodic protection is designed for the 6-inch welded gas main shown in figure D-1. This pipeline is not yet constructed, so measurements cannot be taken.

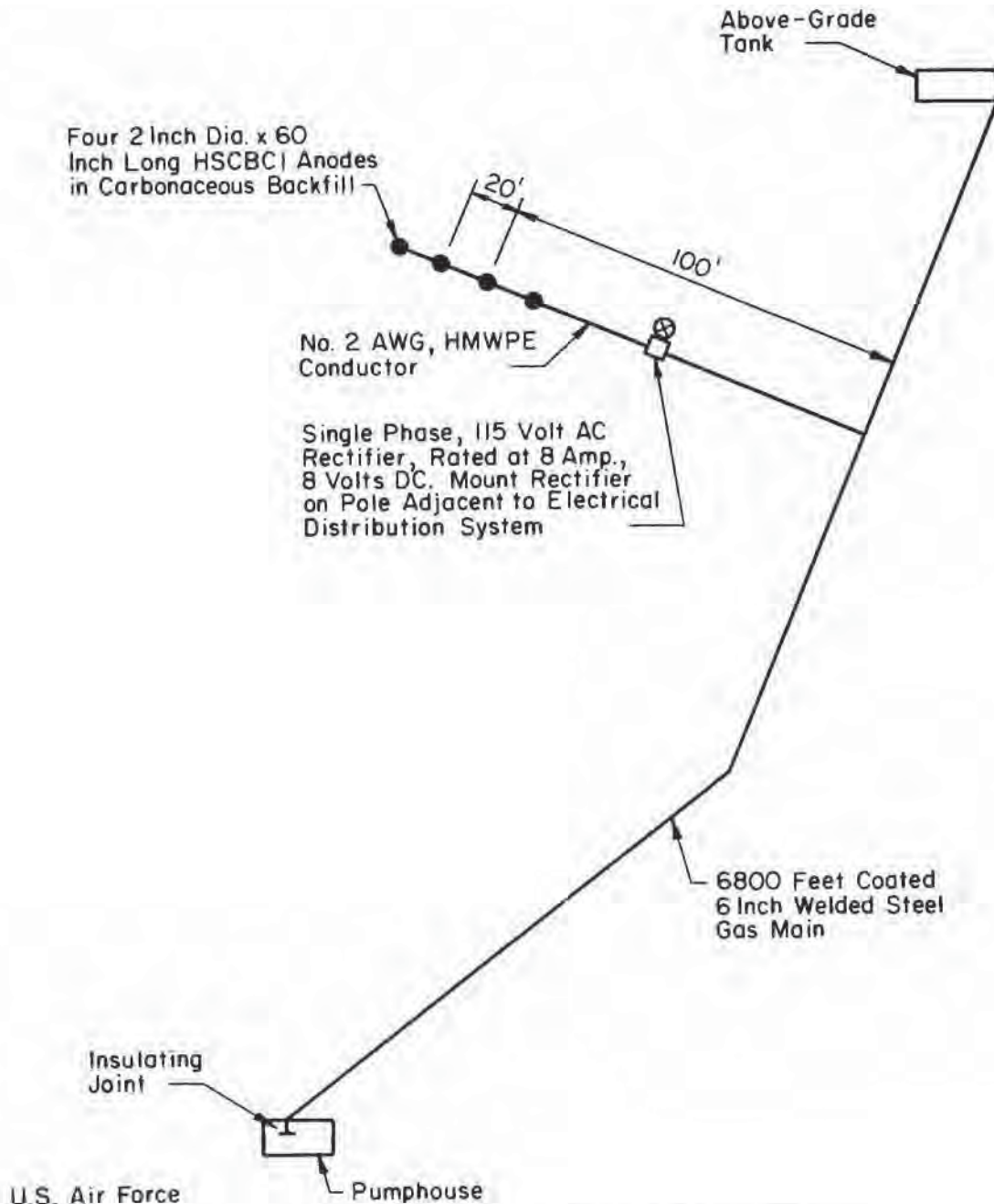

Figure D-1. Cathodic protection system for gas main.

TM 5-811-7

a. Design data.

- (1) Average soil resistivity is 2000 ohm-centimeters.
- (2) Effective coating resistance at 15 years is estimated at 2500 ohms per square foot.
- (3) Pipe has a 6-inch outside diameter.
- (4) Pipe length is 6800 feet.
- (5) Design for 15-year life.
- (6) Design for 2 milliamperes per square foot of bare pipe.
- (7) Design for 90 percent coating efficiency based on experience.
- (8) The pipeline must be isolated from the pumphouse with an insulating joint on the main line inside the pumphouse.
- (9) HSCBCI anodes must be used with carbonaceous backfill.
- (10) The pipe will be coated with hot-applied coal-tar enamel and will be holiday-checked before installation.
- (11) Anode bed must not exceed 2 ohms.
- (12) Electric power is available at 120/240 volts a.c. single phase from a nearby overhead distribution system.
- (13) Current requirement test indicates that 2.36 amperes are needed for adequate cathodic protection.

b. Computations.

- (1) Find the gas main's outside area:

Pipe size - 6 in.

Pipe length - 6800 ft

$$\text{Pipe area} = 6800 \times \frac{\pi}{4} \times \left(\frac{6}{12}\right)^2 = 10,681 \text{ sq ft.}$$

- (2) Check the current requirement using equation 2-1:

$$I = (A)(I')(1.0 - CE)$$

$$I = 10681 \text{ sq ft} (2 \text{ mA/sq ft})(1.0 - 0.9)$$

$$I = 2136 \text{ mA,}$$

which agrees with the current requirement test in 13 above.

- (3) Select an anode. From table 2-4, choose the 60-pound anode with a 2.8-square-foot surface area (arbitrary selection).

- (4) Calculate the number of anodes needed to meet the anode supplier's current density limitations; use equation 2-9:

$$N = \frac{I}{(A_1)(I_1)}$$

$$N = \frac{2360 \text{ mA}}{(2.8 \text{ sq ft/anode})(1000 \text{ mA/sq ft})}$$

(Recommended maximum current density output for high-silicon chromium-bearing cast-iron anodes is 1000 mA/sq ft.)

$$N = 0.84 \text{ anode}$$

- (5) Calculate the number of anodes required to meet the design life requirements from equation 2-10:

$$N = \frac{(L)(I)}{(1000)(W)}$$

$$N = \frac{(15 \text{ years})(2360 \text{ mA})}{(1000)(60 \text{ lb/anode})} = 0.59 \text{ anode}$$

(6) Calculate the number of anodes required to meet maximum anode grounded resistance requirements from equation 2-11:

$$R_a \cdot \frac{(\cdot K)}{LN} \cdot \frac{\cdot P}{S}$$

$$N \cdot \frac{\cdot K}{L (R_a \cdot \frac{\cdot P}{S})}$$

$$N \cdot \frac{2000 \text{ ohm} \cdot \text{cm} (0.016S)}{7 \text{ ft} (20 \text{ ohm} \cdot \frac{(2000 \text{ ohm/cm} (0.016S))}{20 \text{ ft}})}$$

(Values for K and P from tables 2-6 and 2-7, respectively.)

$$N = 2.75 \cdot 3 \text{ anodes.}$$

(7) Select the number of anodes to be used. Since the last calculation resulted in the largest number of anodes, it will be used. The grounded resistance, Ra, using three anodes, would equal 1.86 ohms; to insure compliance with the manufacturer's limitations, four anodes will be used.

(8) Select an area for anode bed placement. The area of lowest resistivity will be used, which is 100 feet from the pipeline.

(9) Determine the total circuit resistance.

(a) Calculate the anode grounded resistance using equation 2-11:

$$R_a \cdot \frac{(\cdot K)}{LN} \cdot \frac{\cdot P}{S}$$

$$R_a \cdot \frac{2000 \text{ ohm} \cdot \text{cm} (0.0165)}{(4 \text{ anodes})(7 \text{ ft})} \cdot \frac{(2000)}{S}$$

(Values for K and P are from tables 2-6 and 2-7, respectively.)

$$R_a = 1.46 \text{ ohm.}$$

(b) Calculate the grounded resistance for a 50-foot header cable using equation 2-12. The resistance specified by the manufacturer is 0.0159 ohm per 100 ft of No.2 AWG cable:

$$R_w = (\text{ohms/ft})(L)$$

$$R_w = (0.0159 \text{ ohm}/100 \text{ ft})(500 \text{ ft}) = 0.0795 \text{ ohm.}$$

(c) Calculate the structure-to-electrolyte resistance from equation 2-14:

$$R_c \cdot \frac{R}{N}$$

$$R_c \cdot \frac{2500 \text{ ohm/sq ft}}{11,800 \text{ sq ft}}$$

$$= 0.212 \text{ ohm}$$

TM 5-811-7

(d) Calculate the total resistance (eq 2-15):

$$R_T = R_a + R_w + R_c$$

$$R_T = 1.46 \text{ ohm} + 0.0795 \text{ ohm} + 0.212 \text{ ohm}$$

$$R_T = 1.75 \text{ ohms.}$$

(10) Calculate the rectifier voltage from equation 2-16:

$$v_{(\text{rec})} = (I)(R_T)(150\%)$$

$$v_{(\text{rec})} = (2.36 \text{ A})(1.75 \text{ ohms})(150\%)$$

$$v_{(\text{rec})} = 6.2 \text{ V.}$$

c. *Select rectifier.* Based on the design requirement of 6.2 volts and 2.36 amperes, a rectifier can be chosen from those marketed. After a rectifier has been chosen, the system's cost can be calculated in accordance with paragraph 2-2. A comparison with other anode sizes and types will yield the most economical design.

D-3. Heating distribution system.

Impressed current cathodic protection is designed for a well coated, buried heating distribution system as shown in figure D-2. The distribution system has not yet been installed, so measurements cannot be made. Rectifier size need not be calculated, because it is sized in the field after anode installation.

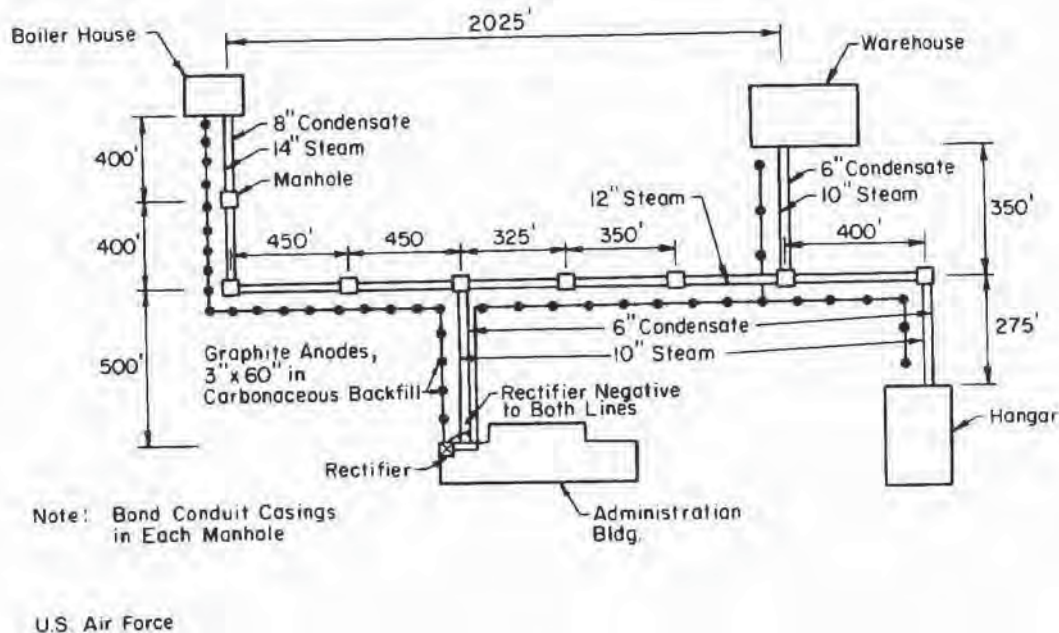

Figure D-2. Impressed current cathodic protection for heating conduit system.

a. *Design data.*

- (1) Average soil resistivity is 1000 ohm-centimeters.
- (2) Design for 80 percent coating efficiency based on experience.
- (3) Design for 4 milliamperes per square foot of bare metal heating conduits.
- (4) Groundbed resistance must not exceed 1.5 ohms.
- (5) Graphite anodes must be installed with carbonaceous backfill.
- (6) Design for a 15-year life.

- (7) Insulating joints must be provided on both steam and condensate lines at the first flange connection inside all buildings.
- (8) All conduit must be metal-bonded together in each manhole.
- (9) All conduit will be precoated at the factory and will not have been holiday-checked.
- (10) Single-phase electrical power is available at 120/240 volts a.c. from the administration building.

b. *Computations.*

- (1) Find the conduit's total outside area. Because the gage of the metal from which the conduit is made ranges between 14 and 16, the pipe's outside diameter is considered the same as the inside diameter.
 - (a) Steam conduit area must be calculated (table D-1).

Table D-1. Dimensions for finding steam conduit area: heat distribution system

Conduit size (in.)	Conduit length (ft)	Conduit area (sq ft/ (lin ft)	Conduit area (sq ft)
14	1700	3.67	6239
12	1125	3.14	3533
10	1525	2.62	<u>3996</u>
Total area of steam conduit		13,768	

U.S. Air Force

- (b) Condensate return conduit area must be calculated (table D-2).

Table D-2. Dimensions for finding condensate return conduit area: heat distribution system

Conduit size (in.)	Conduit length (ft)	Conduit area (sq ft/ (lin ft)	Conduit area (sq ft)
8	1700	2.09	3553
6	2650	1.57	<u>4161</u>
Total area of condensate return conduit			7713
Total outside area of all conduit			21481

U.S. Air Force.

- (2) Find the area of bare pipe to be cathodically protected based on 80 percent coating efficiency:

$$A = 21,481 \times 0.2$$

$$A = 4296 \text{ sq ft.}$$

- (3) Find the maximum protective current required based on 4 milliamperes per square foot of bare metal:

$$I = 4296 \times 4$$

$$I = 17,184 \text{ mA or } 17.2 \text{ A.}$$

- (4) Compute the maximum weight of anode material needed for 15 years' life.

- (a) Graphite anodes are used.

- (b) Average deterioration rate for graphite is 2.0 pounds per ampere-year.

TM 5-811-7

(c) Find the maximum weight of anode material required (use eq C-1 from appendix C):

$$W \cdot \frac{YSI}{E},$$

where Y = 15 years, S = 2.0 pounds per ampere-year, I = 17.2 amperes, and E = 0.50 efficiency. Thus,

$$W \cdot \frac{(15 \text{ yr})(2.0 \text{ lb/A} \cdot \text{yr})(17.2\text{A})}{0.50},$$

$$W = 1032 \text{ lb.}$$

c. *Groundbed design.*

(1) Anode size is 3-inch by 60-inch (backfilled 10-inch by 84-inch) and weight is 25 pounds per anode unit.

(2) Find the resistance to earth of a single anode:

$$R_v \cdot \frac{PK}{L}, \tag{eq D-1}$$

where P = 1000 ohm-centimeters, L = 7.0 feet (backfilled size), and K = 0.0167, L/d = 8.4 (table 2-6). Thus,

$$R_v \cdot \frac{(1000 \text{ ohm} \cdot \text{cm})(0.0167)}{7.0 \text{ feet}},$$

$$R_v = 2.39 \text{ ohms}$$

(3) Compute the number of anodes required. The low resistance (2.39 ohms) of a single anode and the heavy weight of anode material required (1032 pounds) for a 15-year life indicate that the controlling factor is the amount of anode material, not groundbed resistance. The minimum number of anodes (N) required is

$$N = 1032/25 = 41.3 \text{ or } 41 \text{ anodes.}$$

These are arranged in a distributed groundbed as shown in figure D-2 based on the following estimates.

(4) Anode distribution:

(a) Conduit area in sections 1 through 6 of figure D-2 are given in table D-3.

Table D-3. Conduit area: heat distribution system

Section	Length (ft)	Surface area (sq ft)
1	1700	3553 + 6239 = 9792
2	500	785 x 1310 = 2095
3	1125	1766 x 3533 = 5299
4	350	550+ 917=1467
5	400	628 + 1048 = 1676
6	275	432 + 721=1153

U.S. Air Force.

(b) The area of conduit protected by one anode is —

$$A = 21,481/41$$

$$A = 524 \text{ sq ft/anode.}$$

(c) Anodes will be divided as shown in table I)-4.

Table D-4. Anode division: heat distribution system

Section	Surface area/ anode protective area	Number of anodes
1	9792/524 =	19
2	2095/524 =	4
3	5299/524 =	10
4	1467/524 =	3
5	1676/524 =	3
6	1153/524 =	2

U.S. Air Force.

d. *Rectifier location.* Locate the rectifier in front of the administration building as figure D-2 shows. The rectifier will be sized after anodes are installed.

D-4. Black iron hot water storage tank.

Impressed current cathodic protection is designed for the interior of a black iron hot water storage tank as shown in figure D-3.

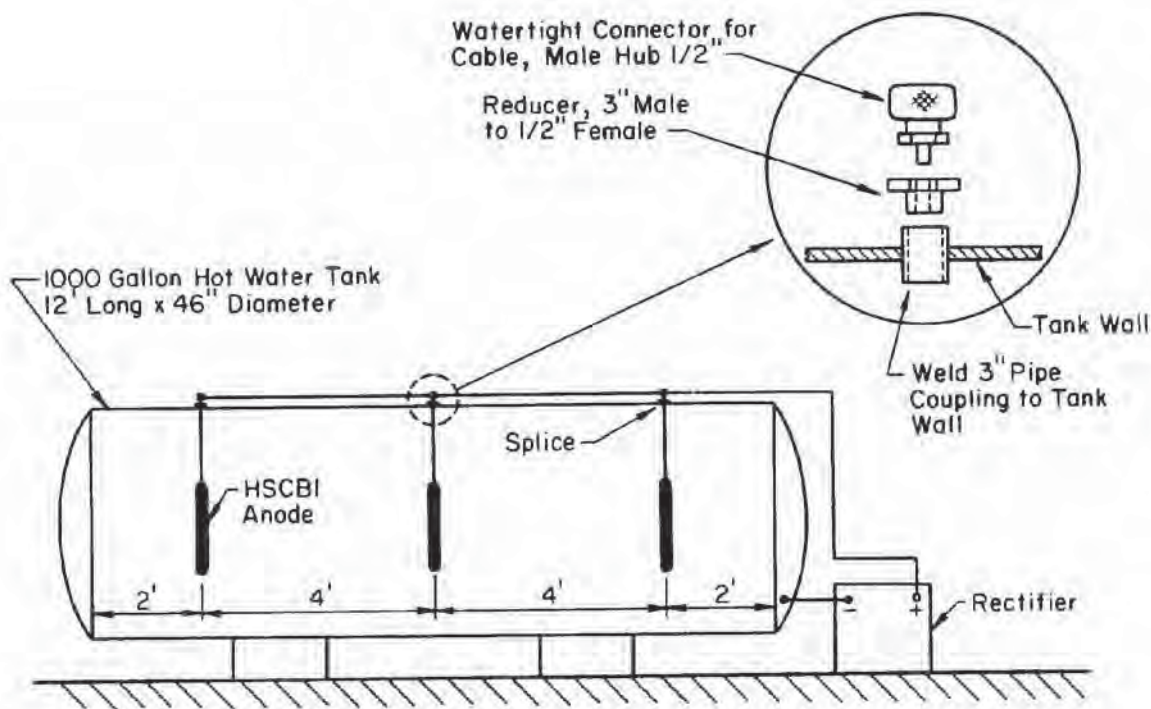

U.S. Air Force

Figure D-3. Cathodic protection for black iron hot water storage tank.

a. *Design data.*

- (1) Tank capacity is 1000 gallons.
- (2) Tank dimensions are 46 inches in diameter by 12 feet long.
- (3) The tank is mounted horizontally.
- (4) Water resistivity is 8600 ohm-centimeters with a pH of 8.7.
- (5) The tank's inside surface is bare and water temperature is maintained at 180 degrees Fahrenheit.

TM 5-811-7

- (6) Design for a maximum current density of 5 milliamperes per square foot.
 - (7) Design for a 5-year life.
 - (8) Use HSCBCI anodes.
 - (9) Electrical current is available at 115 volts a.c., single phase.
- b. *Computations.*

- (1) Find the tank's interior area using equation D-2:

$$A_T = 2 \pi r^2 + \pi dL,$$

where $r=1.92$ feet, $d=3.83$ feet, and $L = 12$ feet. Thus,

$$A_T = 2 \times 3.1416 \times (1.92)^2 + 3.1416 \times 3.83 \times 12$$

$$A_T = 167.5 \text{ sq ft.}$$

- (2) Find the maximum protective current required:

$$I = 167.5 \times 5$$

$$I = 838 \text{ mA or } 0.84 \text{ A.}$$

- (3) Find the minimum weight of anode material needed for a 5-year life (eq C-I from appendix C):

$$W = \frac{YSI}{E},$$

where $Y = 5$ years, $S = 1.0$ pound per ampere-year, $I = 0.84$ ampere, and $E = 0.50$. Thus,

$$W = \frac{(5 \text{ yr})(1.0 \text{ lb/A} \cdot \text{yr})(0.84 \text{ A})}{0.50}$$

$$W = 8.4 \text{ lb.}$$

- (4) Compute the number of anodes required. An anode 1½ inches in diameter by 9 inches long weighing 4 pounds is chosen as the most suitable size. For proper current distribution, three anodes are required.

- (5) Find the resistance of a single anode using equation D-3:

$$R = \frac{0.012P \log (d/D)}{L} \quad (\text{eq D-3})$$

where $P = 8600$ ohm-centimeters, $D = 3.83$ feet (tank diameter), $d = 1\frac{1}{2}$ inches or 0.125 foot (anode diameter), $L = 9$ inches or 0.75 foot (anode length). Thus,

$$R = \frac{0.012 \times (8600 \text{ ohm} \cdot \text{cm}) \log (3.83 \text{ ft}/0.125 \text{ ft})}{0.75 \text{ ft}}$$

$$R = \frac{103.2 \times \log 30.64}{0.75}$$

$$R = 204.5 \text{ ohms}$$

This resistance must be corrected by the fringe factor because the anodes are short. The fringe factor is 0.48 from the curve in figure D-4 for an $L/d = 9/1.5 = 6$:

$$R = 204.5 \times 0.48$$

$$R = 98.2 \text{ ohms.}$$

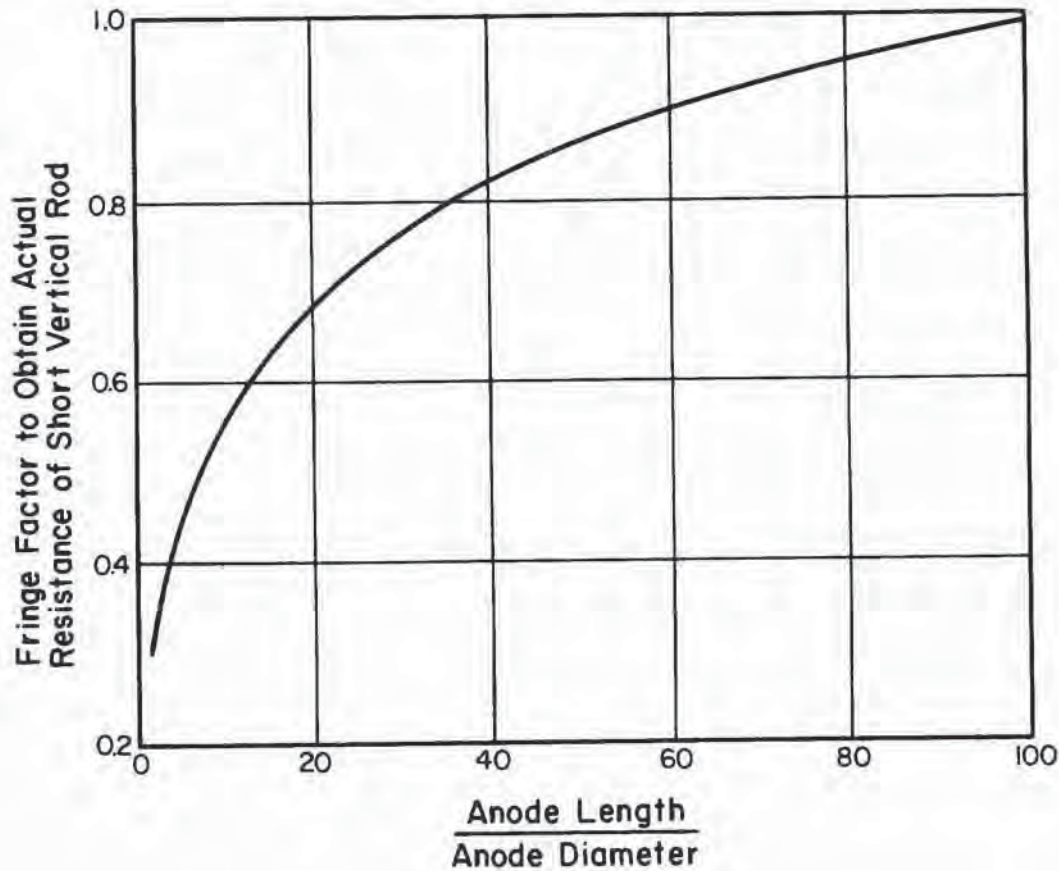

U.S. Air Force

Figure D-4. Fringe factor for stub anodes.

(6) Find the resistance of a three-anode group using an equation based on equation 2-11:

$$R_n = \frac{1}{N} R_v \cdot \frac{\cdot \cdot P}{S},$$

where R_n = the total anode-to-electrolyte resistance, N = number of anodes, R_v = resistance-to-electrolyte of a single anode, P = electrolyte resistivity, P = paralleling factor from table 2-7, and S = spacing between anodes (feet). Thus,

$$R_n = \frac{1}{3} 98.2 \cdot \frac{8600 \times 0.00289}{4}$$

$$R_n = 38.94 \text{ ohms}$$

(7) Find the rectifier rating:

$$E = IR,$$

where $I = 0.84$ ampere and $R = 38.94$ ohms. Thus,

$$E = 0.84 \times 38.94$$

$$E = 32.7 \text{ V.}$$

TM 5-811-7

(a) To allow rectifier aging and film formation, it is considered good practice to use 1.5 as a multiplying factor:

$$E = 1.5 \times 32.7 = 49.1 \text{ V.}$$

(b) The rectifier chosen should produce a d.c. voltage that meets the size requirements of 60-volt, 4-ampere, single-phase.

(8) Locate the rectifier adjacent to tank for the following reasons:

- (a) Usually cheaper to install.
- (b) Easier to maintain.
- (c) Keeps d.c. voltage drop to a minimum.

(9) The d.c. circuit conductors should be installed as follows:

(a) Outside tank — use No.2 AWG high molecular weight polyethylene extruded (HMWPE) conductor.

(b) Inside tank — use No.8 AWG HMWPE conductor.

(10) The cable should not be stressed or bent.

D-5. Elevated water tank (ice is expected).

Impressed current cathodic protection is designed for an elevated water tank as shown in figure D-5. The tank is already built and current requirement tests have been done. Anodes must not be suspended from the tank roof because heavy ice (up to 2 feet thick) covers the water surface during winter. The anode cables could not tolerate this weight, so another type of support must be used. Button anodes must be mounted on the tank's floor and lightweight platinized titanium anodes must be suspended in the riser from the tank bottom.

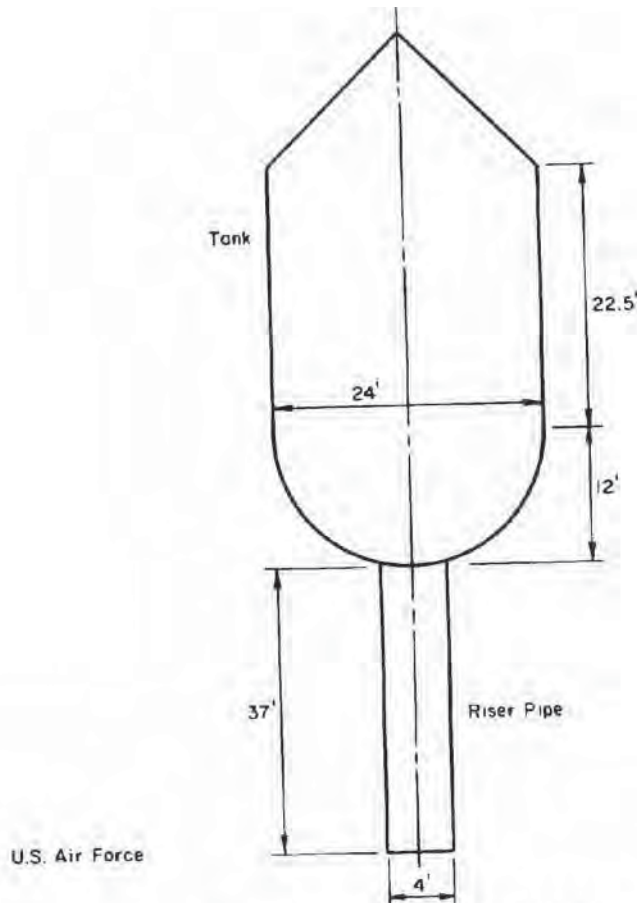

Figure D-5. Dimensions for an elevated steel water tank.

a. *Design data.*

- (1) Tank height (from ground to bottom of bowl) is 37 feet.
- (2) Tank diameter is 24 feet.
- (3) High water level in the tank is 34.5 feet.
- (4) Overall tank depth is 34.5 feet.
- (5) Vertical shell height is 22.5 feet.
- (6) Riser pipe diameter is 4 feet.
- (7) The tank has a semicircular bottom.
- (8) All inner surfaces are uncoated.
- (9) Current required for protection — bowl, 7.0 amperes, rise, 1.0 ampere.
- (10) Electrical power available is 120/240-volt a.c., single phase.
- (11) Tank is subject to freezing.
- (12) Design for a 15-year life.
- (13) Water resistivity is 4000 ohm-centimeters.
- (14) Button-type HSCBCI anodes are used for the tank.
- (15) Riser anodes are platinized titanium wire.

b. *Computations.*

- (1) Find the minimum weight of button anode material required for the tank (eq C-1 from appendix C):

$$W = \frac{YSI}{E},$$

where Y = 15 years, S = 1.0 pound per ampere-year, I = 7.0 amperes, and E = 0.50. Thus,

$$W = \frac{(15 \text{ yr})(1.0 \text{ lb/A} \cdot \text{yr})(7.0 \text{ A})}{0.50},$$

$$W = 210 \text{ lb.}$$

- (2) Compute the number of tank anodes needed (button anodes weigh 55 pounds):

$$N = \frac{210}{55} \cdot 3.82 \text{ (use 4 anodes).}$$

- (3) Find the minimum weight of riser anode material required for the riser (eq C-I from appendix C):

$$W = \frac{YSI}{E},$$

where Y = 15 years, S = 1.32×10^{-5} pound per ampere-year, I = 1.0 ampere, and E = 0.50. Thus,

$$W = \frac{(15 \text{ yr})(1.32 \times 10^{-5} \text{ lb/A} \cdot \text{yr})(1.0 \text{ A})}{0.50}$$

$$W = 3.96 \times 10^{-4} \text{ lb.}$$

(4) Find the number of riser anodes needed. Platinized titanium wire, 0.1-inch in diameter, 3 feet long, with .001-inch-thick platinum over titanium will be used for each anode. The weight of platinum on each anode is 8.8×10^{-5} pound. Thus,

$$N = \frac{3.96 \times 10^{-4}}{8.8 \times 10^{-5}} \cdot 4.5 \text{ (use 5 anodes).}$$

- (5) locate anodes as shown in figure D-6.

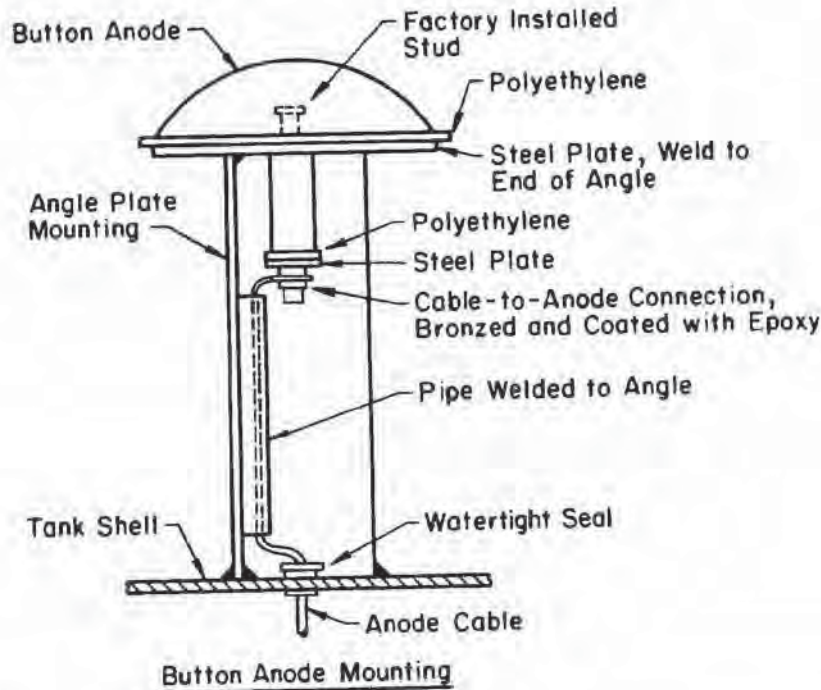
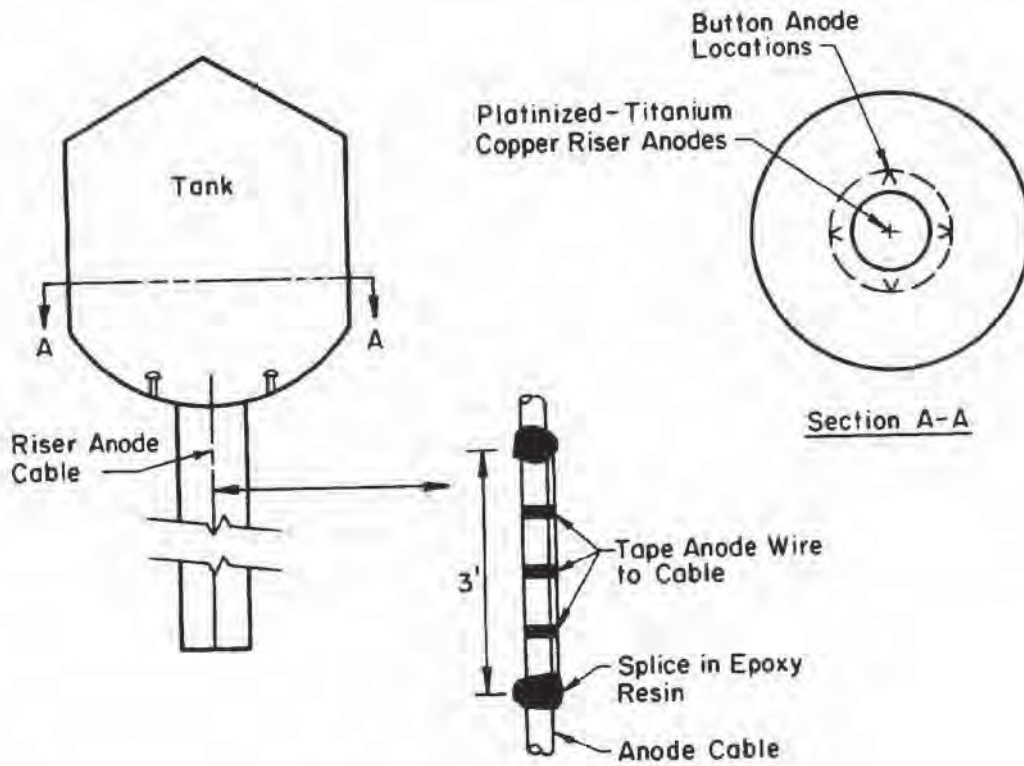

U.S. Air Force

Figure D-6. Cathodic protection for tanks using rigid-mounted, button-type anodes and platinized titanium wire.

(a) Button anodes are mounted on the tank bases at a distance of one-fourth the tank diameter (??? feet) from the center. They are mounted on metal angles and plates that are welded to the tank bottom; polyethylene insulation is required to separate the anode from the metal mounting. Riser anodes are

suspended in the center of the riser pipe and are spliced to a No.4 AWG cable. The top anode is placed 1 foot from the tank base. The remaining four anodes are spaced at 4-foot intervals.

(b) Each button anode has its own No.8 AWG 7-strand copper cable (HMWPE) run in conduit to a resistor box mounted at eye level on a tank leg. The riser anode's one No.4 AWG 7-strand cable is run in conduit to the resistor box. If required to get proper current output, a resistor must be installed in the riser anode circuit at the time of rectifier sizing. The rectifier must be sized after the anodes are installed and must be mounted at eye level adjacent to the resistor box.

D-6. Elevated steel water tank.

This impressed current design is for a tank that has not been built; thus, it is not possible to measure current requirements and other factors. Calculated estimates are used.

a. Design data.

- (1) Tank capacity will be 500,000 gallons.
- (2) Tank height (from ground to bottom of bowl) will be 115 feet.
- (3) Tank diameter will be 56 feet.
- (4) The tank's high water level will be 35 feet.
- (5) Overall tank depth will be 39 feet.
- (6) Vertical shell height will be 11 feet.
- (7) Riser pipe diameter will be 5 feet.
- (8) Tank will be ellipsoidal on both top and bottom.
- (9) All inner surfaces will be uncoated.
- (10) Design for a maximum current density of 2 milliamperes per square foot.
- (11) Electric power available will be 120/240-volt a.c., single phase.
- (12) String-type HSCBCI anodes will be used.
- (13) Design for a 10-year life.
- (14) Water resistivity is 4000 ohm-centimeters.
- (15) The tank water must not be subjected to freezing.
- (16) An assumed deterioration rate is 1.0 pound per ampere-year.
- (17) Anode efficiency (assumed) is 50 percent.

b. Computations.

- (1) Find the area of wetted surface or tank bowl (figure D-7).

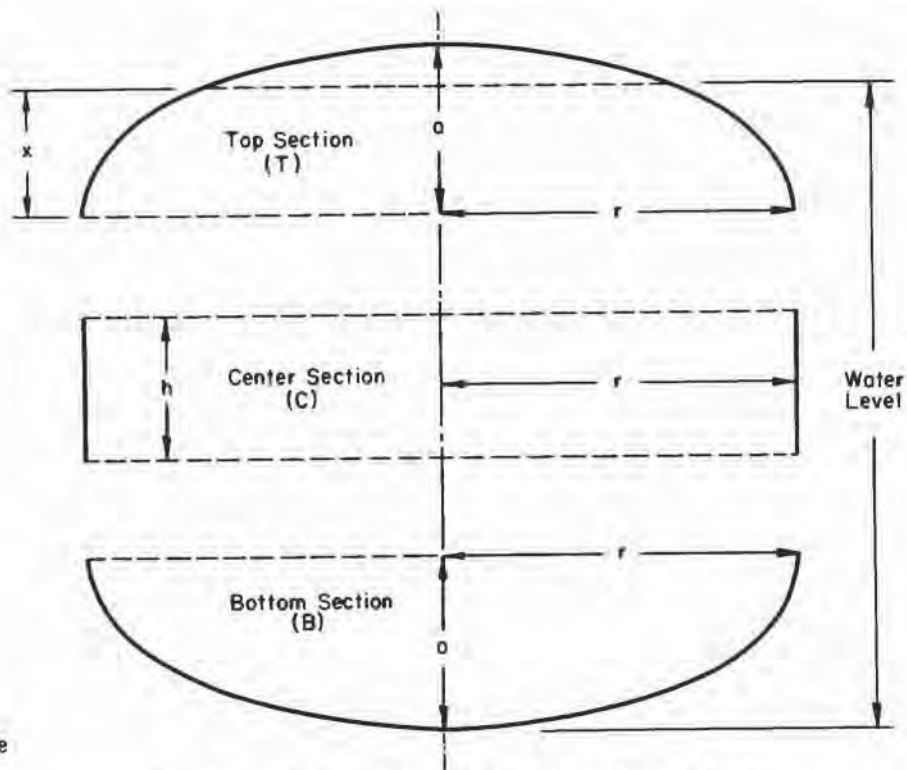

U.S. Air Force

Figure D-7. Segmented elevated tank for area calculations.

TM 5-811-7

(a) For the top section (T)—

$$A_T = 2 \cdot r x \text{ (approximately),}$$

where $r = 28$ feet (tank radius), $x = 10$ feet. Thus,

$$A_T = 2 \times 3.1416 \times 28 \text{ ft} \times 10 \text{ ft}$$

$$A_T = 1759 \text{ sq ft.}$$

(b) For the center section (C)—

$$A_c = 2 \cdot r h,$$

(eq D-5)

where $r = 28$ feet (tank radius) and $h = 11$ feet. Thus,

$$A_c = 2 \times 3.1415 \times 28 \text{ ft} \times 11 \text{ ft}$$

$$A_c = 1935 \text{ sq ft.}$$

(c) For the bottom section (b)—

$$A_B = \sqrt{2} \sqrt{r a^2 + r^2},$$

(eq D-6)

where $r = 28$ feet (tank radius) and $a = 14$ feet. Thus,

$$A_B = \sqrt{2} \times 3.1416 \times 28 \text{ ft} \times \sqrt{14 \text{ ft}^2 + 28 \text{ ft}^2},$$

$$A_B = 3894 \text{ sq ft.}$$

(d) Therefore, the total wetted area of the tank bowl is—

$$A_T + A_C + A_B \text{ or } 7588 \text{ sq ft.}$$

(2) Find the riser pipe's area using equation D-7:

$$A_r = 2 \cdot r_R h_R,$$

(eq D-7)

where $r_R = 2.5$ feet (riser radius) and $h_R = 115$ feet (riser height). Thus,

$$A_R = 2 \times 3.1416 \times 2.5 \text{ ft} \times 115 \text{ ft}$$

$$A_R = 1806 \text{ sq ft}$$

(3) Find the maximum design current for the tank:

$$I_T = 2.0 \text{ mA/sq ft} \times 7588 \text{ sq ft}$$

$$I_T = 15,176 \text{ mA or } 15.2 \text{ A.}$$

(4) Find the maximum design current for the riser:

$$I_R = 2.0 \text{ mA/sq ft} \times 1806 \text{ sq ft}$$

$$I_R = 3612 \text{ mA or } 3.62 \text{ A.}$$

(5) Find the minimum weight of tank anode material needed (eq C-1 from appendix C):

$$W = \frac{YSI}{E},$$

where $Y = 10$ years, $S = 1.0$ pound per ampere-year, $E = 0.50$, and $I = 15.2$ amperes. Thus,

$$W = \frac{(10 \text{ yr})(1.0 \text{ lb/A} \cdot \text{yr})(15.2 \text{ A})}{0.50},$$

$$W = 304 \text{ lb.}$$

(6) Compute the minimum weight of riser anode material needed (eq C-1):

$$W \cdot \frac{YSI}{E},$$

where Y = 10 years, S = 1.0 pound per ampere-year, I = 3.62 amperes, and E = 0.50.

$$W \cdot \frac{(10 \text{ yr})(1.0 \text{ lb/A} \cdot \text{yr})(3.62\text{A})}{0.50},$$

$$W = 72.4 \text{ lb.}$$

(7) Find the main anode circle's radius using equation D-8:

$$r = (DN)/2(\pi + N) \tag{eq D-8}$$

where D = 56 feet and N = 10 (assumed number of anodes). Thus,

$$r \cdot \frac{56 \text{ ft} \times 10}{2(3.1416 \cdot 10)}$$

$$r = 560/26.28$$

$$r = 21.3 \text{ ft, use } 22 \text{ ft.}$$

(8) Determine the spacing for the main anodes. Generally, the distance from the anode to the tank wall and tank bottom is about equal; this distance should be about one-half the circumference between anodes.

(a) To find circumferential spacing, use equation D-9:

$$C = (2 \cdot r) / N \tag{eq D-9}$$

where r = 22 feet (anode circle radius) and N = 10 (assumed number of anodes). Thus,

$$C \cdot \frac{2 \times 3.1416 \times 22 \text{ ft}}{10}$$

$$C = 13.8 \text{ ft, use } 14 \text{ ft.}$$

(b) The cord spacing is approximately the same as circumferential spacing; 14 feet will be used (fig D-8).

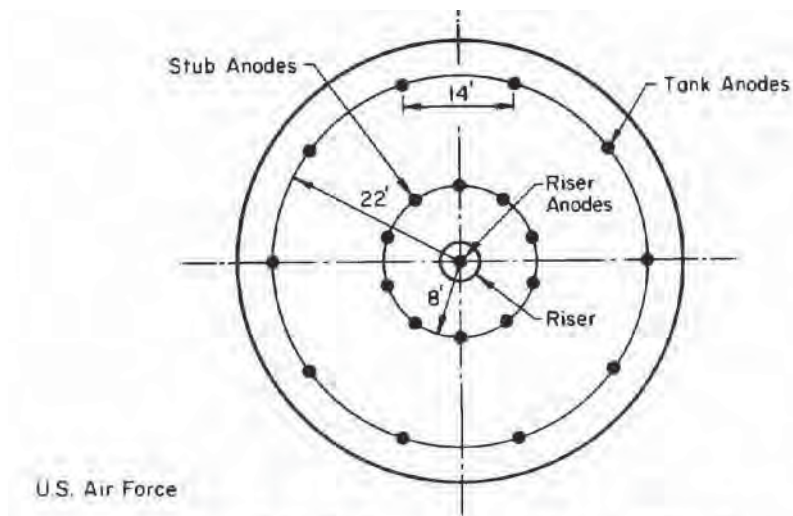

Figure D-8. Anode spacing for elevated steel water tank.

TM 5-811-7

(9) Select the main anodes.

(a) The anode unit size chosen is 1C-inch outside diameter, 3/4-inch inside diameter, and 9 inches long. This is a standard sausage-type anode that weighs 1 pound and has a surface area of 0.25 square foot.

(b) The minimum number of anode units per anode string (N), based on a required weight of 304 pounds and 10 anode strings, is computed as follows:

$$N = 304 / (10 \times 1)$$

$$N = 30.4, \text{ use 31 units per string.}$$

(c) Because the inside tank surfaces are uncoated, a maximum structure-to-electrolyte voltage is not a limiting factor. However, because it is desired to hold the anode current at or below the manufacturer's recommended discharge rate of 0.025 ampere per anode for this type anode, the minimum number of anodes will be—

$$\frac{15.2 \text{ A}}{10 \times 0.025 \text{ A}} \cdot 60.8 \text{ (use 61 anodes per string.)}$$

This number is not practical for the bowl since the distance between the anode hanger and tank bottom is only 28 feet. Table D-5 shows the maximum recommended current discharge per anode for various types of anodes to insure a 10-year minimum life. Using a type B anode, three anodes per string are required. The manufacturer does not recommend more than two type B anodes per string assembly because the strings are fragile. Therefore, the best choice of anode for the main anode strings is type C or CDD. Type CDD is recommended because the lead wire connection is protected longer by the thicker wall of the enlarged ends. Two type CDD anodes per string provide a current capacity of 2 amperes 10 strings = 20 amperes. These anodes are spaced as shown in figure D-9.

Table D-.5. Technical data—commonly used HSCBCI anodes

Anode type	Size (in.)	Weight (lb)	Anode max discharge (A)	Area (sq ft)	Max current density (A/sq ft)
FW ^a	1C OD x 9	1	0.025	0.2	0.1
FC ^b	1½ x 9	4	0.075	0.3	0.25
G-2	2 OD x 9	5	0.100	0.4	0.25
G-2½	2½ x 9	9	0.20	0.5	0.40
B ^{c,d}	1 x 60	12	0.50	1.4	0.36
C	1½ x 60	25	1.00	2.0	0.50
CDD ^c	1½ x 60	26	1.00	2.0	0.50
M ^c	2 x 60	60	2.5	2.8	0.9
SM	4½ x 60	20	10.0	5.5	1.8
K-6	6 x 2½	16	0.225	0.5	0.45
K-12	12 x 3 7/16	53	0.80	1.0	0.80
B-30	1 x 30	7	0.25	0.7	0.36
TA-2	2 1/16 x 84	46	6.4	4.0	1.6

^aFor elevated freshwater tank.

^bFor distributed system in ground trench.

^cEach end enlarged with cored opening for wire.

^dNot more than two anodes per assembly.

U.S. Air Force.

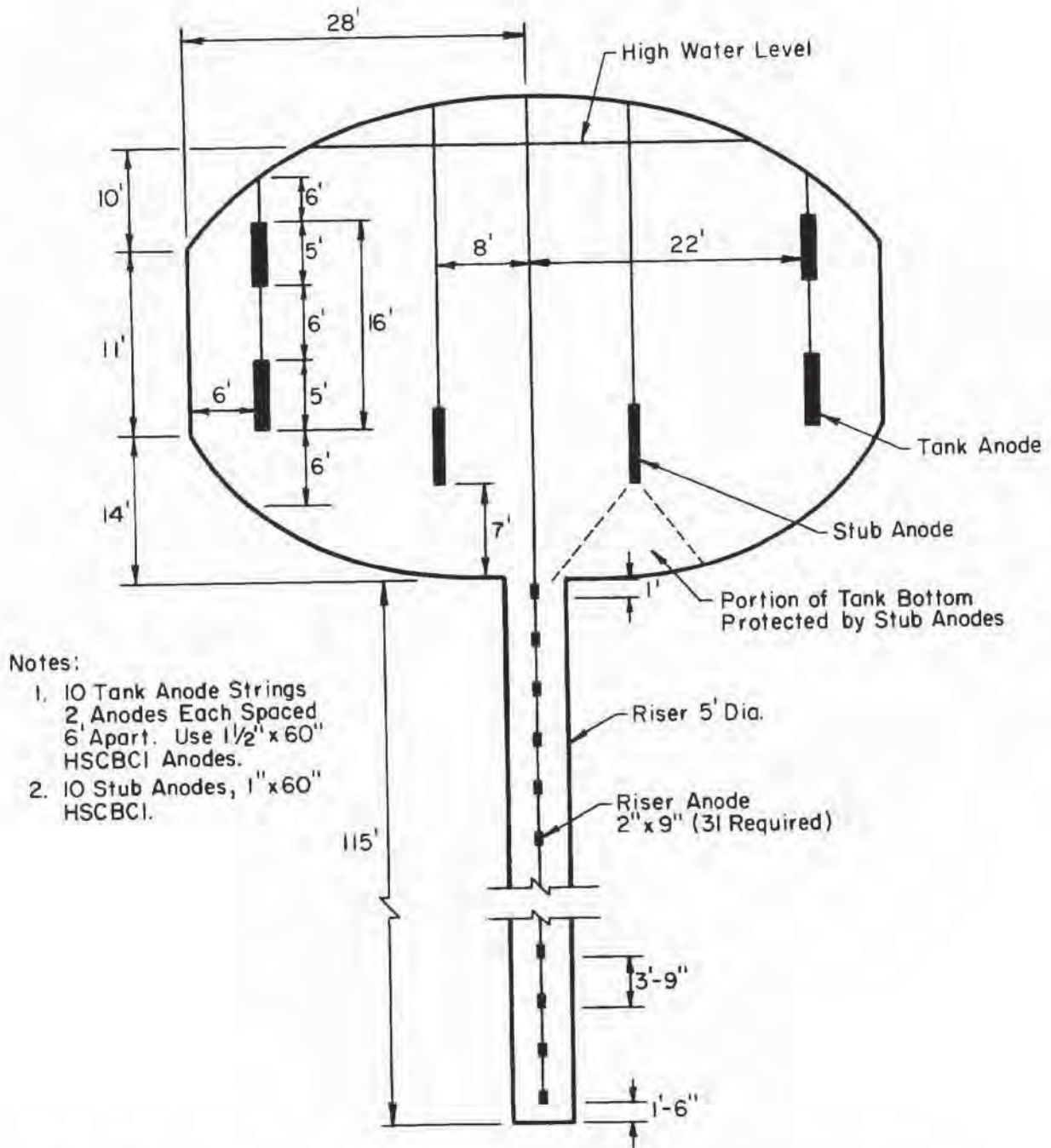

U.S. Air Force

Figure D-9. Anode suspension arrangement for elevated steel water tank.

(d) Anode current density is computed as follows:

$$\text{Output} \cdot \frac{15.2}{2 \times 10 \times 2}$$

$$= 0.38 \text{ A/sq. ft.}$$

TM 5-811-7

(10) Find the main anodes' resistance (substituting a for d in eq D-3):

$$R = \frac{0.012P \log (D/a)}{L},$$

where P = 4000 ohm-centimeters, D = 56 feet, L = 2 x 5 feet = 10 feet, and a = 44 x 0.275 = 12.1 feet (0.275 = equivalent diameter factor from curve, fig. D-10). Thus,

$$R = \frac{(0.102)(4000 \text{ ohm} \cdot \text{centimeters}) \log (56 \text{ ft}/12.1 \text{ ft})}{10 \text{ ft}}$$

$$R = \frac{48 \log 4.628}{10}$$

$$R = 3/19 \text{ ohms}$$

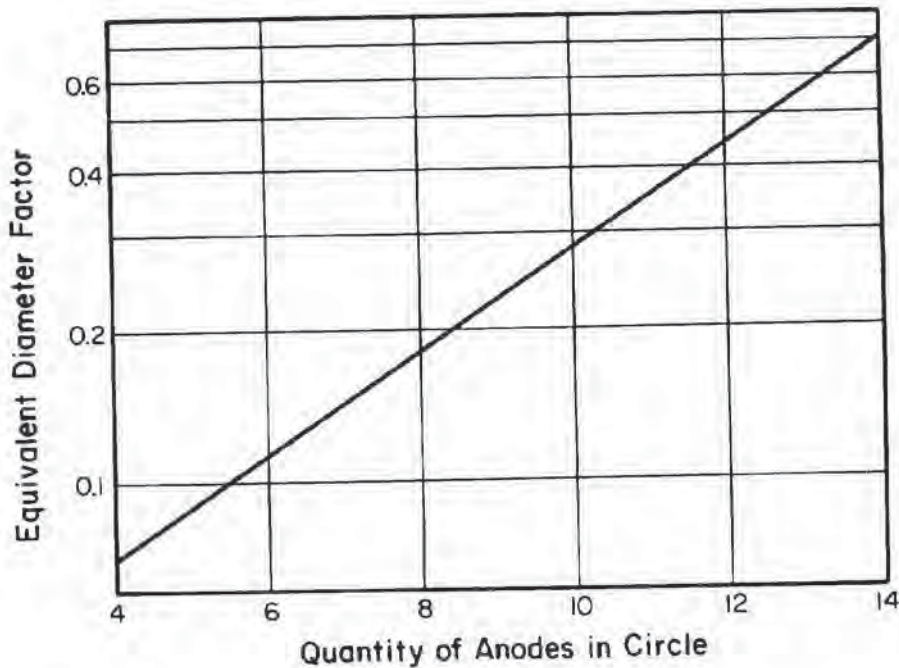

U.S. Air Force

Figure D-10. Equivalent diameter factor for anodes in a circle in water tank.

(a) However, the L/d ratio of two 1½ inch diameter, 60-inch long anodes in tandem is less than 100, so the fringe factor must be used:

$$L/d = (2 \times 60)/1.5$$

$$L/d = 80 < 100.$$

(b) The fringe factor from figure D-4 corresponding to this L/d ratio is 0.95. Thus,

$$R \text{ (adjusted)} = 3.19 \times 0.95$$

$$R = 3.03 \text{ ohms.}$$

(11) In designing an elevated water tank, the need for stub anodes must be justified.

(a) The main anode radius has been calculated to be 22 feet. The main anodes are spaced to provide approximately the same distance from the sides and the bottom of the tank. The main anodes will protect a

length along the tank bottom equal to 1½ times the spacing of the anode from the bottom.

(b) The anode suspension arrangement for the tank being considered is shown in figure D-9. It can be seen that stub anodes are required for this design. Ten stub anodes are spaced equally on a circumference with a radius of 8 feet in a way shown in figure D-8. For smaller diameter tanks, stub anodes may not be required.

(12) Find the current division between main and stub anodes.

(a) The area of tank bottom protected by stub anodes is found by equation D-10 (fig D-9):

$$A_s = \pi (r_2^2 - r_1^2), \quad (\text{eq D-10})$$

where $r^2 = 13$ feet (protected segment radius) and $r^1 = 2.5$ feet (riser radius). Thus,

$$A_s = 3.1416 (132 \text{ sq ft} - 2.52 \text{ sq ft})$$

$$A_s = 3.1416 \times 162.75$$

$$A_s = 511.3 \text{ sq ft.}$$

(b) The maximum current for stub anodes is therefore—

$$I_s = 2.0 \times 511.3$$

$$I_s = 1022.6 \text{ milliamperes or } 1.02 \text{ amperes.}$$

(c) The maximum current for the tank bowl is 15.2 amperes.

(d) The maximum current for main anodes is—

$$I_m = 15.2\text{A} - 1.02\text{A}$$

$$I_m = 14.2\text{A.}$$

(13) Find the rectifier voltage rating.

(a) The electrical conductor to the main anode is wire size No.2 AWG, rated at 0.159 ohm per 1000 feet, and has an estimated length of 200 feet. Thus, the resistance of the wire, R, is:

$$R = \frac{200 \text{ ft}}{1000 \text{ ft}} \times 0.159 \text{ ohm} = 0.032 \text{ ohm.}$$

(b) For the voltage drop in the main anode feeder—

$$E = IR,$$

where $I = 14.2$ amperes and $R = 0.032$ ohm. Thus,

$$E = 14.2 \text{ A} \times 0.032 \text{ ohm}$$

$$E = 0.45 \text{ V.}$$

(c) For the voltage drop through the main anodes—

$$E = IR,$$

where $I = 14.2$ amperes and $R = 3.03$ ohms. Thus,

$$E = 14.2 \text{ A} \times 3.03 \text{ ohms.}$$

$$E = 43.0 \text{ V.}$$

(d) The total voltage drop in main anode circuit is thus—

$$E_T = 0.45 + 43.0$$

$$E_T = 43.45 \text{ or } 45 \text{ V.}$$

Use a multiplying factor (safety factor) of 1.5 to get 67.5 volts.

TM 5-811-7

(14) Select the stub anodes. Because it is desirable to use as small an anode as possible without exceeding the manufacturers' recommended rate, try using type FC, HSCBCI anode that measures 1½-inches by 9 inches. Use one anode per string as shown in figure D-9. Anode current density is computed as follows:

$$\text{Output} = 1.02 / (10 \times 0.03) = 0.34 \text{ A/sq ft.}$$

Because this exceeds the recommended maximum anode current density shown in table D-1, the type B anode is the best choice.

(15) Find the stub anodes' resistance (from eq D-3):

$$R = \frac{0.012P \log (D/a)}{L},$$

where $P = 4000$ ohm-centimeter, $D = 56$ feet, $L = 5$ feet, and $a = 16 \cdot 0.275 = 4.4$ feet (factor from fig D-10)

$$R = \frac{(0.012)(4000 \text{ ohm} \cdot \text{centimeters}) \log (56 \text{ ft}/4.4 \text{ ft})}{5 \text{ ft}}$$

$$R = \frac{48 \log 12.73}{5}$$

$$R = \frac{48 \times 1.105}{5}$$

$$R = 10.6 \text{ ohms.}$$

$$L/d = 60/1 = 60 < 100$$

Using the fringe factor from curve figure D-4, 0.90—

$$R \text{ (adjusted)} = 10.6 \times 0.90 = 9.54 \text{ ohms.}$$

(16) Find the voltage drop in the stub anode circuit.

(a) The electrical conductor to the stub anodes is wire size No.2 AWG, rated at 0.159 ohm/1000 feet, and has an estimated length of 200 feet. Thus,

$$R = (200 \text{ ft}/1000 \text{ ft}) \times 0.159 \text{ ohm}/1000 \text{ ft} = 0.032 \text{ ohm.}$$

(b) To find the voltage drop in the stub anode feeder—

$$E = IR$$

where $I = 1.02$ amperes and $R = 0.032$ ohm. Thus,

$$E = 1.02 \text{ A} \times 0.032 \text{ ohm}$$

$$E = 0.033 \text{ V.}$$

(c) Find the voltage drop in anode suspension conductors. First, compute the resistance (R) for an estimated 50-foot-long, No.2 AWG wire rated at 0.159 ohm per 1000 feet:

$$R = (50/1000) \times 0.159 = 0.008 \text{ ohm.}$$

$$E = IR,$$

where $I = 1.02/10 = 0.102$ ampere and $R = 0.008$ ohm. Thus,

$$E = 1.02 \text{ A} \times 0.008 \text{ ohm}$$

$$E = \text{negligible.}$$

(d) Find the voltage drop through the stub anodes given that the rectifier output is 80 volts, the anode current (I) is 1.02 amperes, and the resistance (R) is 9.54 ohms:

$$E = IR$$

$$E = 1.02 \text{ A} \times 9.54 \text{ ohms}$$

$$E = 9.73 \text{ V.}$$

(e) Find the total voltage drop in the stub anode circuit.

$$E_T = 0.033 + 9.73$$

$$E_T = 9.76 \text{ V.}$$

(f) Since the stub anode voltage is below the 45 volts calculated for the main tank anode circuit, the necessary current adjustment can be made through a variable resistor in the stub anode circuit.

(17) Choose a stub anode circuit variable resistor.

(a) The resistor should be able to carry the maximum anode circuit current and have enough resistance to reduce the anode current by one-half when full rectifier voltage is applied to the anode circuit.

(b) Stub anode circuit data are: rectifier output = 80 volts, anode current = 1.02 amperes, and anode resistance = 9.54 ohms.

(c) The variable resistor rating is found by—

$$R = E/I,$$

where $E = 80$ volts and $I = 1.02/2$ or 0.51 ampere. Thus,

$$R = 80/0.51$$

$$R = 156.9 \text{ ohms}$$

$$\text{Resistor's ohmic value} = 156.9 - 9.54$$

$$= 147.4 \text{ ohms.}$$

To find the resistor's wattage rating —

$$P = I^2R \tag{eq D-11}$$

$$P = (1.02)^2 \times 147.4$$

$$P = 153.4 \text{ W.}$$

The commercially available resistor that nearest meets the above requirements is a 175-watt, 200-ohm, 1-ampere size.

(18) Find the riser anodes' resistance. To get the maximum desired current in the riser (3.62 amperes), the resistance limit is calculated as follows:

$$R = E/I,$$

where $E = 43.45$ volts and $I = 3.62$ amperes. Thus,

$$R = 43.5 \text{ V}/3.62 \text{ A}$$

$$R = 12.0 \text{ ohms}$$

(19) Design the riser anode.

(a) Type FW (1-C-inch by 9-inch) string-type anodes cannot be used in the riser because the maximum anode current discharge of 0.025 ampere per anode would be exceeded. The number of type FW anodes required would be 145, placed continuously throughout the riser. This number is too high. The best choice of anode for a flexible riser string is type G-2 (2-inch by 9-inch) high-silicon cast-iron anode.

TM 5-811-7

(b) The number of units required is found from equation D-3:

$$R \cdot \frac{0.012P \log (D/d)}{L},$$

or

$$L \cdot \frac{0.012P \log (D/d)}{R},$$

where P = 4000 ohm-centimeters, D = 5 feet, d = 2 inches or 0.166 foot, and R = 12 ohms. Thus,

$$L \cdot \frac{(0.012)(4000 \text{ ohm} \cdot \text{cm}) \log (5 \text{ ft}/0.166 \text{ ft})}{12 \text{ ohms}}$$

$$L \cdot \frac{48 \times \log 30.1}{12}$$

$$L \cdot \frac{48 \times 1.479}{12}$$

$$L = 5.92 \text{ ft.}$$

The number of units is thus —

$$5.92/0.75 = 7.9 \text{ or } 8 \text{ units.}$$

For proper current distribution in the riser pipe, the anode units should not be placed too far apart. It is generally considered that each anode unit protects a length along the riser pipe equal to 1½ times the spacing of the anode from the riser pipe wall. Therefore, for a riser height of 115 feet, spacing (center of anode to tank wall) should be 2.5 feet. The riser length protected by one anode is 1.5 x 2.5 = 3.75 feet, so the number of units required is 115/3.75=30.7 or 31 units. To satisfy the maximum anode discharge current for a G-2 anode—

$$\frac{3.62 \text{ A}}{0.1 \text{ A}} \cdot 36.$$

Therefore, 36 anodes are needed instead of 31 or 8.

(c) To find the anode resistance using 36 anode units, use equation D-3:

$$R \cdot \frac{0.012P \log (D/d)}{L},$$

where P = 4000 ohm-centimeters, D = 5 feet, d = 2 inches or 0.166 foot, and L = 36 x 9 inches = 324 inches or 27 feet. Thus,

$$R \cdot \frac{(0.012)(4000 \text{ ohm} \cdot \text{cm}) \log (5 \text{ ft}/0.166 \text{ ft})}{27 \text{ ft}}$$

$$R \cdot \frac{48 \times \log 30.1}{27}$$

$$R = 2.63 \text{ ohms}$$

The L/d ratio for the riser anode string is 324/2 or 162; thus, no fringe factor correction is used.

(20) Find the voltage drop in the riser anode circuit.

(a) Electrical conductor to riser anodes. For a wire size No.2 AWG, 0.159 ohm per 1000 feet, and estimated length 200 feet, the resistance (R) is—

$$R \cdot \frac{200 \text{ ft}}{1000 \text{ ft}} \times \frac{0.159 \text{ ohm}}{1000 \text{ ft}}$$

$$R = 0.032 \text{ ohm.}$$

(b) Find the voltage drop in riser anode feeder by—

$$E = IR,$$

where $I = 3.62$ amperes and $R = 0.032$ ohm. Thus,

$$E = 3.62 \text{ A } 0.032 \text{ ohm}$$

$$E = 0.116 \text{ V.}$$

(c) Find the voltage drop in the riser anode suspension cables for wire size No.2 AWG, 0.159 ohm per 1000 feet rating, and estimated length 130 feet;

$$R \cdot \frac{130 \text{ ft}}{1000 \text{ ft}} \times \frac{0.159 \text{ ohm}}{1000 \text{ ft}}$$

$$R = 0.02 \text{ ohm.}$$

$$E = IR$$

where $I = 3.62/2 = 1.81$ amperes average (single current does not flow the full length of the anode string) and $R = 0.02$ ohm. Thus,

$$E = 1.81 \text{ A } \times 0.02 \text{ ohm}$$

$$E = 0.04 \text{ V.}$$

(d) Find the voltage drop through riser anodes:

$$E = IR,$$

where $I = 3.62$ amperes and $R = 2.63$ ohms. Thus,

$$E = 3.62 \text{ A } \times 2.63 \text{ ohms}$$

$$E = 9.52 \text{ V.}$$

(e) Find the total voltage drop in the riser anode circuit:

$$E_T = 0.116\text{V} + 0.04\text{V} + 9.52\text{V}$$

$$E_T = 9.68 \text{ volts.}$$

(21) Select the riser anode circuit variable resistor.

(a) Criteria for the variable resistor are the same as given for the stub anode resistor.

(b) Riser anode circuit data — rectifier output = 80 volts, anode current = 3.62 amperes, anode resistance = $2.63 + 0.032 + 0.02 = 2.68$ ohms.

(c) Variable resistor rating (resistor should reduce anode current by one-half when full rectifier voltage is applied)—

$$r = E/I,$$

where $E = 80$ volts and $I = 3.62/2 = 1.81$ amperes. Thus,

$$R = 80 \text{ V } - 1.18 \text{ A}$$

$$R = 44.2 \text{ ohms.}$$

$$\text{Resistor ohmic value} = 44.2 \text{ ohms } - 2.68 \text{ ohms} = 41.5 \text{ ohms.}$$

$$\text{Resistor wattage rating} = (3.62 \text{ A})^2 \times 41.5 \text{ ohms} = 543.8 \text{ W.}$$

(d) The commercially available resistor that nearest meets the size requirements is a 750-watt, 50-ohm, 3.87-ampere model. This rheostat is 10 inches in diameter and 3 inches deep and is fairly expensive. It

TM 5-811-7

will not fit into most rectifier cases. In addition, the rheostat consumes large amounts of power. This power generates heat that can damage components inside the rectifier case unless good ventilation is provided. The problems found with using a large rheostat can be overcome by using a separate rectifier for the riser anodes. Although initial cost may be slightly high, power savings will be substantial and heat damage will be avoided.

(22) Size the rectifier for the riser.

(a) Requirements—d.c. output = 3.62 amperes, anode circuit resistance = 2.68 ohms, d.c. voltage required = $IR = 3.62 \times 2.68 = 9.70$ volts.

(b) Rectifier rating—standard ratings for a rectifier in this size class is 18 volts, 4 amperes.

(23) Find the rectifier d.c. rating for the bowl. Voltage output has been determined to be 80 volts. Current rating is 15.2 amperes. The commercially available rectifier that nearest meets the above requirements is 80 volts, 16 amperes.

(24) Determine wire sizes and types. All positive feeder and suspension cables (rectifier to anodes) must be No.2 AWG HMWPE insulated copper cable. To avoid complication, the negative rectifier cable (rectifier to structure) must be the same size and type (fig D-11).

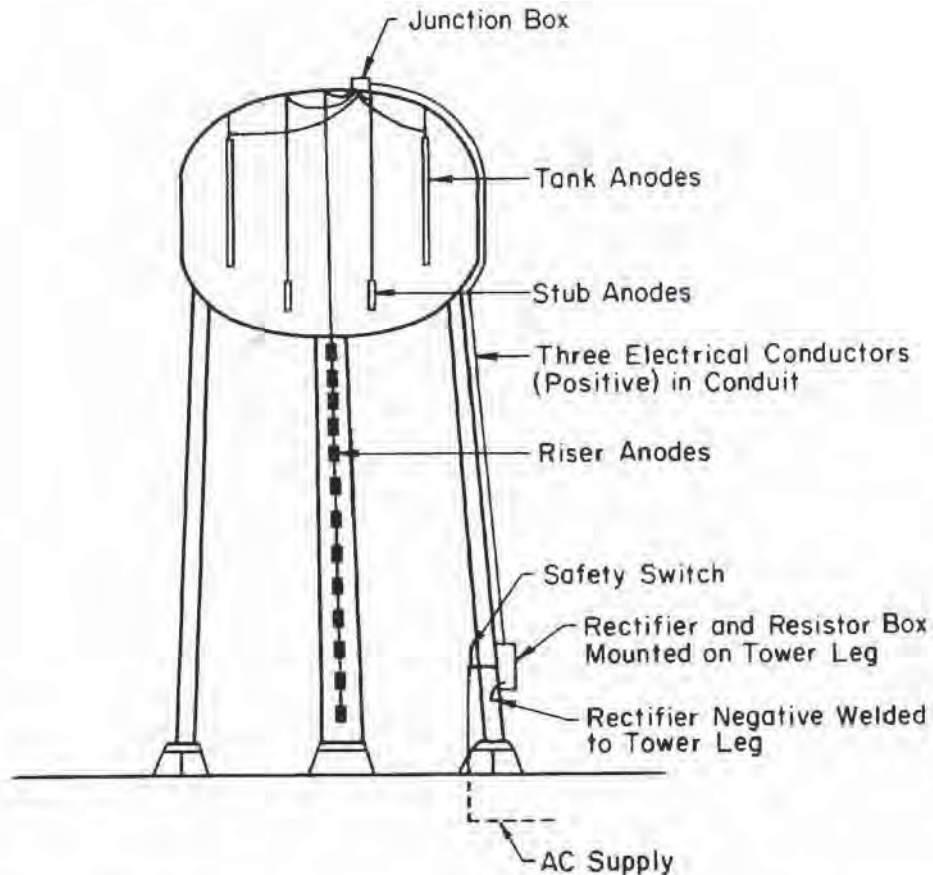

U.S. Air Force

Figure D-11. Elevated steel water tank showing rectifier and anode arrangement.

(25) Discussion of design.

(a) The design points out the drawbacks of controlling corrosion through cathodic protection without the aid of a protective coating. For example, when the inside of a tank is coated, the current requirement is reduced 60 to 80 percent. On large tanks without coating, larger and more costly anodes, wire, and rectifier units must be used. In addition, the uncoated tank consumes far more power. These costs usually exceed the cost of a quality coating system over a 10-year period. Corrosion above the water line of a water storage tank is usually severe because condensation is corrosive. For this reason, protective coatings must be used above the water line on both large and small water storage tanks to slow corrosion.

(b) Figures D-11 through D-13 give more guidance in designing cathodic protection systems for elevated cold water storage tanks.

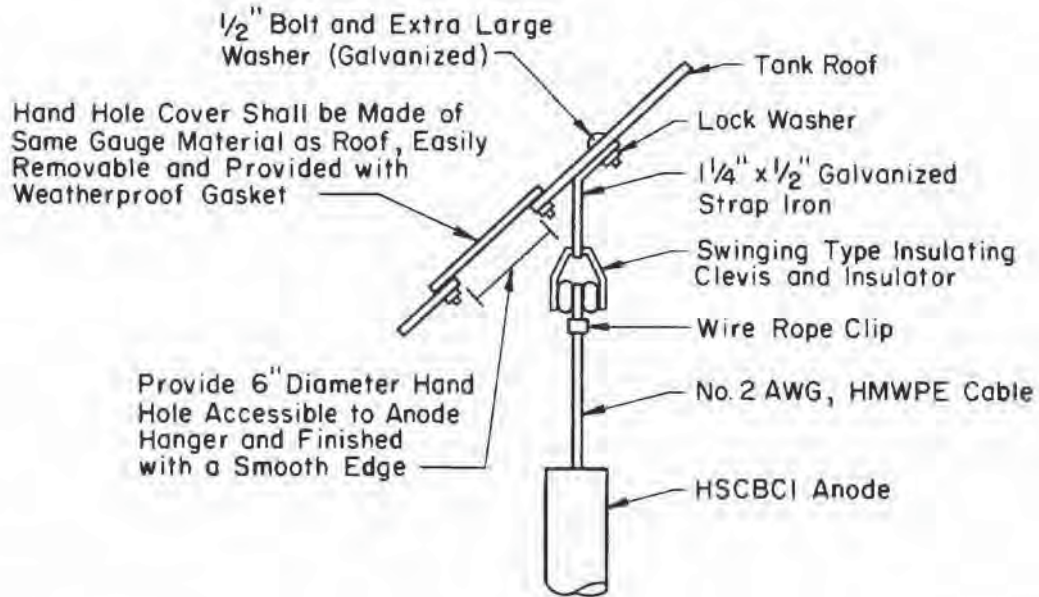

U.S. Air Force

Figure D-12. Hand hole and anode suspension detail for elevated water tank.

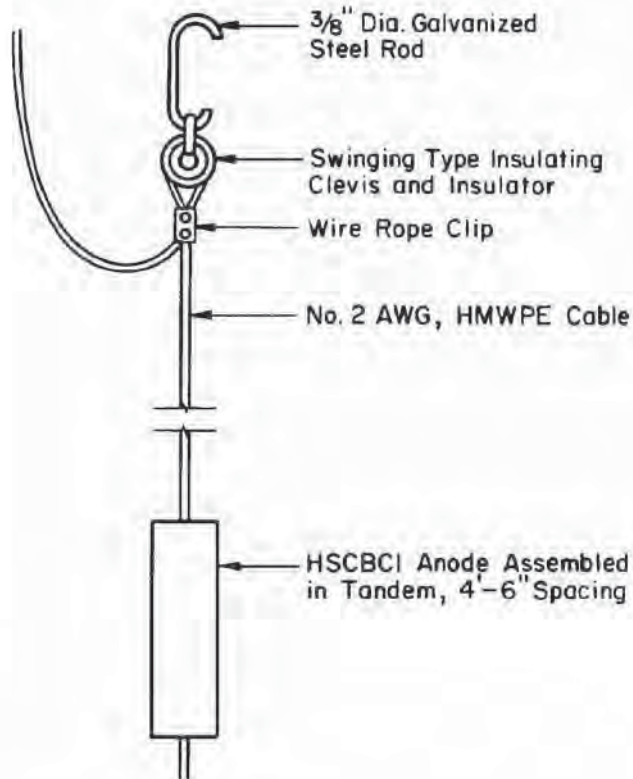

U.S. Air Force

Figure D-13. Riser anode suspension detail for elevated water tank.

(c) HSCBCI was chosen for this design purely as an example. It does not mean this material is better than other anode types. Other acceptable anode materials include aluminum and platinized titanium or niobium.

(d) For this design, silicon cells should be specified for the rectifier that protects the bowl, and selenium cells should be specified for the rectifier that protects the riser. Silicon cells operate more efficiently at high d.c. output voltages than selenium cells, but require elaborate surge and overload protection. This protection is not economical in the low power consuming units. A guide for choosing rectifying cells is as follows: use silicon cells for single-phase rectifiers operated above 72 volts d.c. or for three-phase rectifiers operated above 90 volts d.c.; use newer, nonaging selenium for single-phase rectifiers operated below 72 volts d.c. or three-phase rectifiers operated below 90 volts d.c.

APPENDIX E SPECIFICATIONS FOR CERAMIC ANODE

E-1. Thickness of ceramic coating.

The coating shall be no less than 0.002 inches thick as shown in figure E-1.

- 1) Niobium Substrate
- 2) Brass Connector
- 3) Delrin Gland
- 4) Delrin Ferrule
- 5) Delrin Plug
- 6) Delrin Nut
- 7) Ceramic Coating

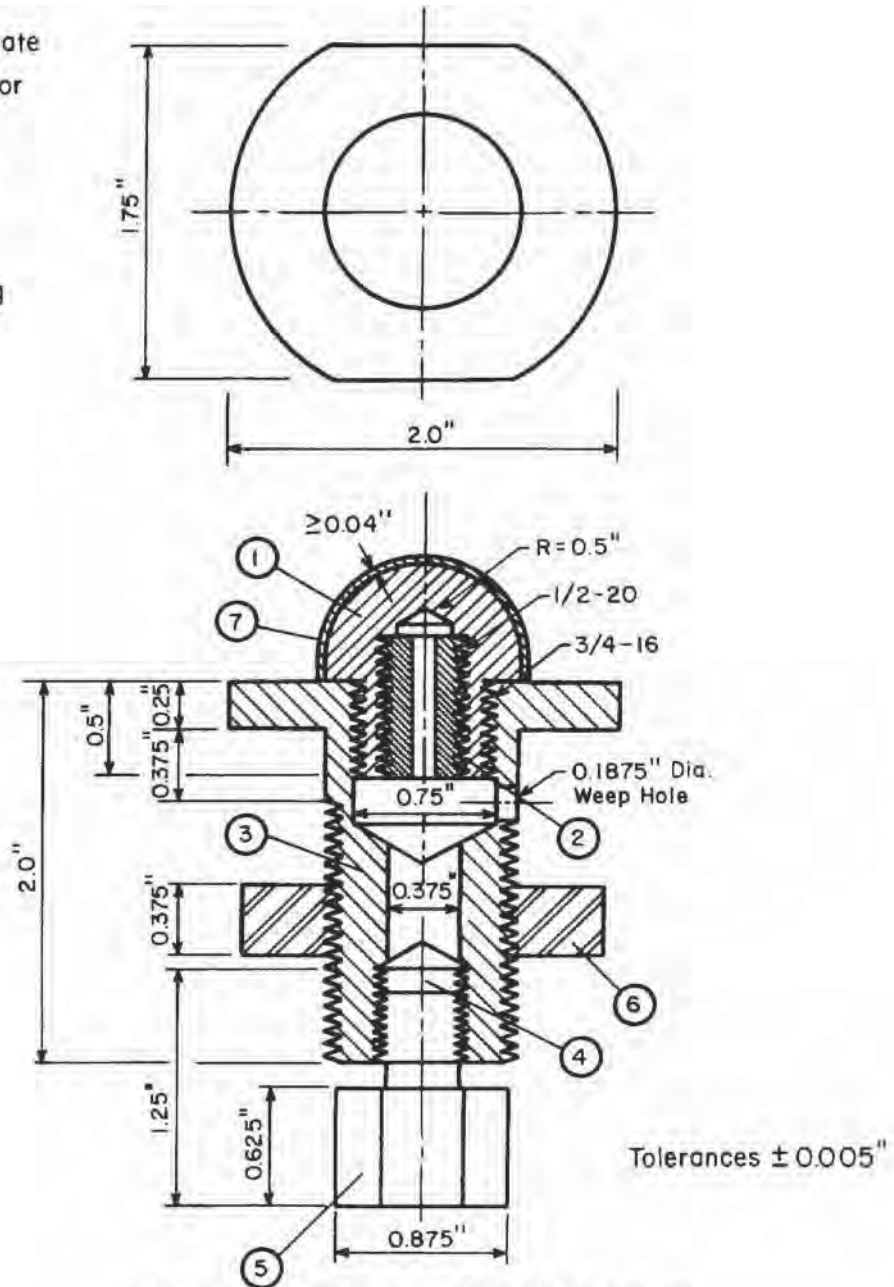

CERAMIC ANODE SPECIFICATIONS

US Army Corps of Engineers

Figure E-1. Ceramic anode specifications.

TM 5-811-7

E-2. Dissolution rate.

For a current density of 20 amperes per square meter—

- Freshwater, 10 grams per ampere-year.
- Saltwater, 15 grams per ampere-year.

E-3. Resistivity.

The anode's resistivity shall be 1500 ohm-centimeters.

E-4. Impact resistance.

A Gardner heavy-duty impact tester (Pacific Scientific, West Silver Spring, MD) shall be used. The anode will be screwed into a modified holder and a round-nose punch 0.625 inches in diameter will be placed on the specimen. A 2-pound weight shall be raised to the desired height in a graduated tube and released. Damage to coatings, such as chipping or cracking, should be observed visually or with low-power (10X) magnification. The sample should withstand a force of 32 inch-pounds when the weight is dropped; the punch should be located within an area $\frac{1}{8}$ inch from the center of the anode without observable damage.

APPENDIX F RECTIFIER CURRENT INTERFERENCE*

F-1. This appendix is taken from an unpublished document by T.F. Lewicki of the U.S. Air Force Civil Engineering Center, Tyndall Air Force Base, FL. It is used in the Air Force Corrosion Reports as an internal document.

F-2. Cathodic interference.

a. Method of detecting cathodic interference.

(1) Cathodic interference may be detected by conducting structure-to-soil potential surveys on all foreign underground structures in the vicinity of the impressed current systems or the structure being protected. The results are usually plotted as a curve as shown in figure F-1.** To save time, a shortcut method of detecting cathodic interference may be used. Base maps showing the locations of the proposed rectifier ground beds, the protected POL system, and all foreign structures should be obtained and studied. A foreign structure is considered to be a structure which is not part of, or metallicity connected to, the protected structure. Foreign underground structures that come close to (400 to 1000 feet) the ground bed and cross or come close to the protected structure at some remote location (greater than 1000 feet from the ground bed) are prime suspects for cathodic interference. All other suspects should not be ruled out, but the structures that fit into the category described in the previous sentence will be the most likely structures to have interference problems. The point at which the foreign structure crosses or comes closest to the protected structure is the most likely point of cathodic interference or current discharge, commonly referred to as *maximum exposure area*. An exception to this would be a case where the foreign structure was well coated. The holiday in the coating closest to the crossing could be a considerable distance from the crossing.

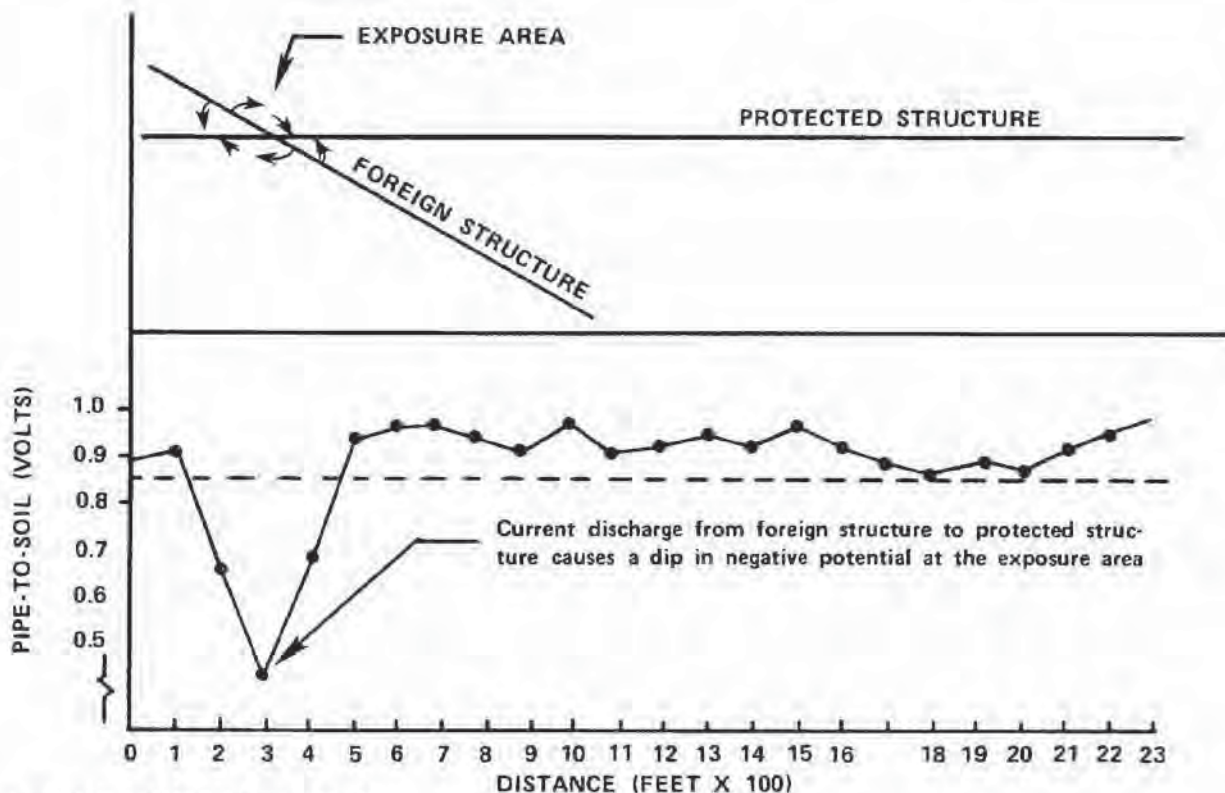

U.S. Army Corps of Engineers

Figure F-1. Structure-to-soil potential versus distance from foreign structure.

*From T. F. Lewicki, Air Force Civil Engineering Center, Tyndall AFB, FL 32401, 1974.

**For discussion purposes, a POL line is to be protected.

(2) To determine if cathodic interference exists at one of these prime suspect areas, the following should be done:

(a) Refer to figure f-2. Using a high-resistance voltmeter (100,000 ohms per volt or higher) or a potentiometer-voltmeter circuit, measure the structure-to-earth potential of the foreign structure at the crossing with all of the proposed rectifiers off. This is called the "natural" or "original" potential. When making this test, one terminal of the voltmeter should be connected to the foreign structure and the other terminal connected to a copper-copper sulfate half-cell electrode. The electrode should be placed on the surface of the earth directly over the structure to be observed.

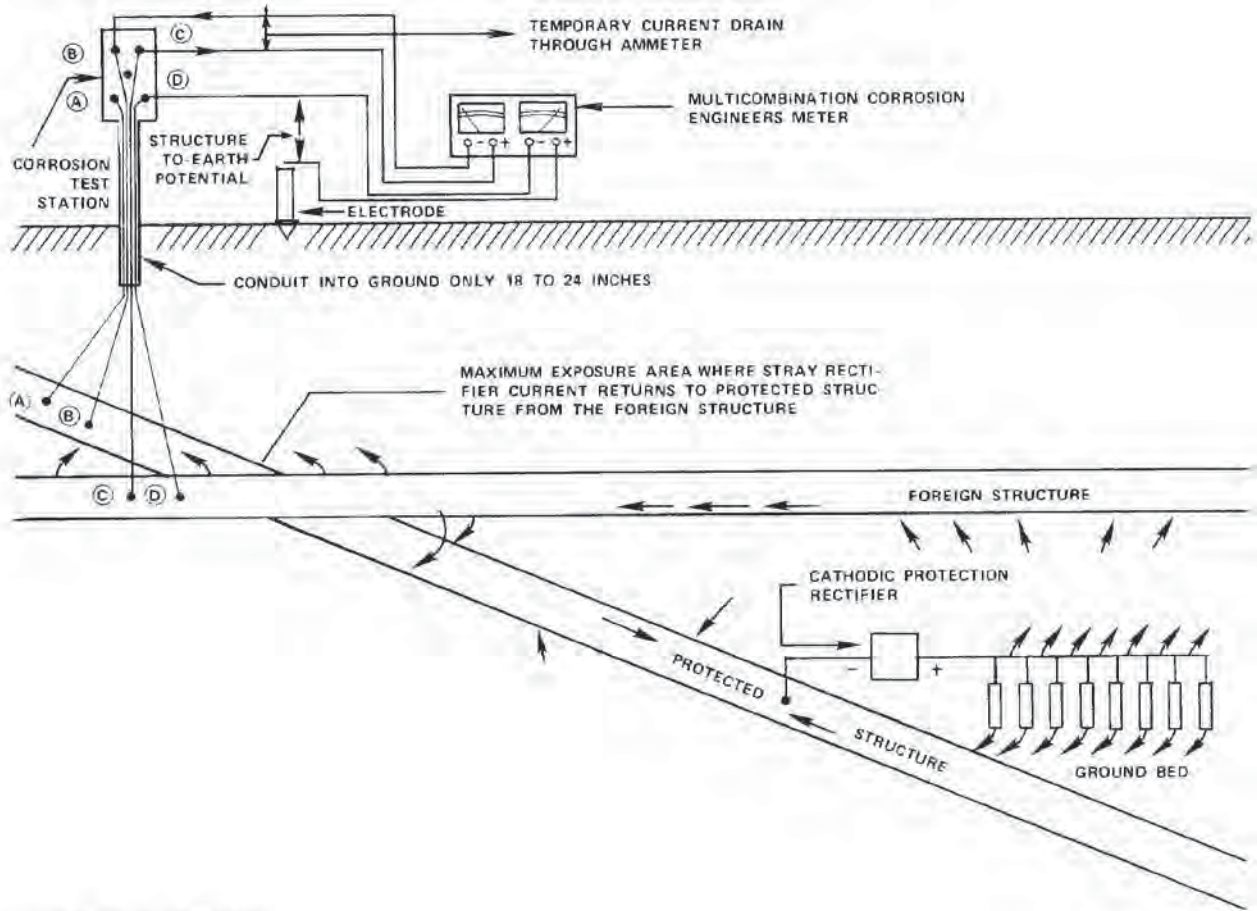

U.S. Army Corps of Engineers

Figure F-2. Cathodic interference testing.

(b) Turn one of the rectifiers on and record the potential as in a above with the electrode in the same location. Repeat this procedure with the other rectifiers one at a time to determine which rectifiers are causing the interference and in what proportion. If the negative structure-to-earth potential is decreased or swung toward the positive direction when the rectifiers are turned on, current is leaving the structure and cathodic interference exists.

b. Correction of interference.

(1) When interference has been discovered, permanent corrosion test stations must be installed. During the preliminary tests for cathodic interference, the minimum size of the wires required for draining the necessary current should be calculated. Make a temporary bond between the foreign structure wire and the protected structure wire. The current drained should be measured by placing a milliammeter or am meter in the circuit. All rectifiers that affect the particular crossing being tested must be turned on for this current drain test. The following measurements must be recorded: natural structure-to-earth potential of foreign structure; structure-to-earth potential of foreign structure with all affecting rectifiers ??? structure-to-earth potential of foreign structure with temporary bond in; current through temporary bond, and potential between the foreign structure and protected structure with temporary bond in. A meter with a small scale such as the

M. C. Miller multicomination corrosion engineer's meter that has ammeter scales as large as 10 amperes or as small as 20 milliamperes or less and a number of small voltmeter scales should be used. The total current required in a resistance bond to clear the interference current leaving the foreign structure can be calculated by using the following simple algebraic formula:

$$\frac{\bullet E_t}{J_d} \bullet \frac{\bullet E_r}{I_t} \quad (\text{eq. F-1})$$

and:

$$I_t \bullet \frac{E_r \times I_d}{\bullet E_t},$$

where $\bullet E_r = E_{fn} - E_{fr} =$ change in structure-to-earth potential required to clear interference; $E_t = E_{fn} - E_{frd} =$ change in structure-to-earth potential caused by the temporary bond; $E_{fn} =$ natural structure-to-earth potential of the foreign structure; $E_{fr} =$ structure-to-earth potential of foreign structure with all affecting rectifiers on; $E_{frd} =$ structure-to-earth potential of foreign structure with temporary bond in; $I_d =$ current through temporary bond; and $T_t =$ total current required through final resistance bond to correct cathodic interference caused by all of the rectifiers. The minimum size of wire required should also be calculated, but wire smaller than No.12 AWG should not be used because of poor mechanical strength. The permanent test station should include two wires thermit welded or brazed to the foreign structure and two wires thermit welded or brazed to the protected structure. This will allow one wire to be used as a current drain while the other is used to measure potential.

(2) After the permanent test station has been installed, the resistance bond can be most easily installed as follows: bare nichrome resistance wire in the range of $\frac{1}{2}$ ohm per foot, or 1 ohm per foot, or 10 ohms per foot, depending on the total resistance needed, should be used.

(a) Since as many as three rectifiers may be involved in an interference bond in the hydrant refueling area, a current interrupter in the rectifier circuit for interrupting all the rectifiers simultaneously would not be practical. All the rectifiers should be turned on and off manually if more than one rectifier is involved. If only one rectifier causes the interference at a particular site, a current interrupter should be placed in the a.c. circuit to interrupt the current output.

(b) Place a copper-copper sulfate half-cell electrode on the surface of the earth at the point of greatest exposure. Measure and record the natural structure to-earth potential of the foreign structure with all interfering electrical circuits off.

(c) After all interfering sources are turned on, insert a portion of nichrome resistance wire between the foreign structure wire and the protected structure wire and observe the structure-to-earth potential of the foreign structure. Increase or decrease the amount of nichrome in the circuit until the structure-to-earth potential of the foreign (the interfered-with) structure becomes equal to the natural potential measured in b above. The current flowing through the resistance bond is now the correct amount and the interference has been cleared. No ammeters or additional test leads can be in series with the resistance bond when this test is made.

(d) Mark or note the exact contact of the nichrome resistance wire with the test station lead wires. Add $\frac{1}{4}$ or $\frac{1}{2}$ inch to each end of these points and cut the nichrome. Crimp an eyelet or fork solderless terminal at the *exact points* where the nichrome contacted the test station lead wires. A permanent resistor has now been fabricated with the exact resistance required for the resistance bond. This resistance may be installed, removed, and reinstalled for testing purposes without changing the value of the resistance. Install the fabricated resistor in the test station and check to see that the natural structure-to-earth potential is achieved. If the potential measured is even a slight amount off, reduce the length of the nichrome or fabricate a longer piece until the natural structure-to-earth potential is achieved with all rectifiers on and resistance bond in (E_{fn} will now equal E_{frd}). When the proper resistor has been fabricated, the wire should be coiled on a pencil to make a neat, compact coil that can be installed inside of the test stations without shorting to the sides of the test station box or the terminals. After the pencil has been removed, the bare nichrome should not be wrapped with tape to allow proper cooling. Primer and tape may be placed inside the test station box to prevent a short. The amount of current flowing through the bond will be equal to the value calculated in

TM 5-811-7

paragraph b above. An ammeter cannot be placed in series with the resistance bond because the resistance would be increased slightly and the current through the bond would be reduced.

c. *Bond installation.* The installation of cathodic interference resistance bonds will reduce the cathodic protection current coming onto the protected POL structure from the electrolyte by an amount equal to the total current flowing through all of the bonds. This total bond current originates from the rectifiers installed to protect the protected structure (the POL system in this case). The portion of rectified or d.c. current equal to the total bond current does not contribute to corrosion mitigation of the POL system. Therefore, the rectified or d.c. current output may have to be increased as bonds are installed to maintain an adequate POL structure-to-earth potential of -0.85 volt.

BIBLIOGRAPHY

- Applegate, L. M., *Cathodic Protection*, McGraw-Hill Book Company, New York, 1960.
- Bryan, W. T., *Designing Impressed Current Cathodic Protection Systems With Durco Anodes*, The Duriron Company, Dayton, OH, 1970.
- Lewicki, T. F., *Rectifier Current Interference*, U.S. Air Force Civil Engineering Center, Tyndall Air Force Base, FL, 1974.
- Myers, J. R. and Aimone, M. A., *Corrosion Control for Underground Steel Pipelines: A Treatise on Cathodic Protection*, James R. Myers and Associates, Franklin, OH, 1980.
- Parker, M. E., "Corrosion by Soils," *NACE Basic Corrosion Course* (A. Brasunus, Ed.), National Association of Corrosion Engineers, Houston, TX, 1980.
- Peabody, A. W., "Principles of Cathodic Protection," *NA CE Basic Corrosion Course* (A. Brasunus, Ed.), National Association of Corrosion Engineers, Houston, TX, 1980.
- Segan, E. and Kumar, A., *Preliminary Investigation of Ceramic-Coated Anodes for Cathodic Protection*, Technical Report M-333/A133440 U.S. Army Construction Engineering Research Laboratory, Champaign, IL, 1983.
- The Custom VIP Cathodic Protection Rectifier*. Technical Bulletin, Goodall Electric, Inc., Fort Collins, CO, January 1982.

GLOSSARY

- adsorption - taking up one substance at the surface of another; tendency of all solids to condense on their surfaces a layer of any gas or solute that contacts such solids.
- aeration cell (oxygen cell) - electrolytic cell in which a difference in oxygen concentration at the electrodes exists, producing corrosion.
- amphoterics - materials subject to attack by both acid and alkaline environments; include aluminum, zinc, and lead (commonly used in construction).
- anaerobic - free of air or uncombined oxygen; anaerobic bacteria are those that do not use oxygen in their life cycle.
- anion - a negatively charged ion that migrates toward the anode under influence of a potential gradient.
- *anode - electrode at which oxidation of its surface or some component of the solution is occurring (opposite: cathode).
- *bell hole - excavation to expose a buried structure.
- cathode - electrode at which reduction of its surface or some component of the solution is occurring (opposite: anode).
- cathodic corrosion - corrosion resulting from a structure's cathodic condition, usually caused by the reaction of alkaline products of electrolysis with an amphoteric metal.
- *cathodic protection - technique to prevent metal surface corrosion by making that surface the cathode of an electrochemical cell.
- cation - positively charged ion of an electrolyte that migrates toward the cathode under the influence of a potential gradient.
- concentration cell - electrolytic cell in which a difference in electrolyte concentration exists between anode and cathode, producing corrosion.
- *continuity bond - metallic connection that provides electrical continuity.
- *corrosion - deterioration of a material, usually a metal, because of a reaction with its environment.
- * current density - current per unit area.
- *electrical isolation - condition of being electrically separated from other metallic structures or the environment.
- *electrosmotic effect - passage of a charged particle through a membrane under the influence of a voltage; soil can act as the membrane.
- *electrode potential - potential of an electrode as measured against a reference electrode. The electrode potential includes no loss of potential in the solution due to current passing to or from the electrodes (that is, it represents the reversible work required to move a unit charged from the electrode surface through the solution to the reference electrode).
- electrolyte - chemical substance or mixture, usually liquid, containing ions that migrate in an electric field; examples are soil and seawater.
- electromotive force series (EMF series) - list of elements arranged according to their standard electrode potentials; the sign is positive for elements with potentials cathodic to hydrogen and negative for those elements with potentials anodic to hydrogen.
- *foreign structure - any structure not intended to be part of the system of interest.
- *galvanic anode - metal that, because of its relative position in the galvanic series, provides sacrificial protection in the galvanic series when coupled in an electrolyte. These anodes are the current source in one type of cathodic protection.
- galvanic cell - corrosion cell in which anode and cathode are dissimilar conductors, producing corrosion because of their innate difference in potential.
- *galvanic series - list of metals and alloys arranged according to their relative potentials in a given environment.
- *holiday - coating discontinuity that exposes the metal surface to the environment.
- hydrogen overvoltage - voltage characteristic for each metal-environmental combination above which hydrogen gas is liberated.

*Definition is from NACE Standard RP-01.

TM 5-811-7

- impressed current - direct current supplied by a power source external to the electrode system.
- *insulating coating system - all components that comprise the protective coating, the sum of which provides effective electrical insulation of the coated structure.
 - *interference bond - metallic connection designed to control electrical interchange between metallic systems.
 - ion - electrically charged atom or molecule.
 - *IR drop - voltage across a resistance according to Ohm's Law.
 - *line current - direct current flowing on a pipeline.
 - local action - corrosion caused by local cells on a metal surface.
 - mill scale - heavy oxide layer formed during hot fabrication or heat-treatment of metals. Applied chiefly to iron and steel.
 - Molality - concentration of a solution expressed as the number of gram molecules of the dissolved substance per 1000 grams of solvent.
 - PH - measure of hydrogen ion activity defined by $\text{pH} = \log_{10} (1/a_{\text{H}^+})$, where a_{H^+} = hydrogen ion activity = molal concentration of hydrogen ions multiplied by ion activity coefficient ($a = 1$ for simplified calculations).
 - polarization - deviation from the open circuit potential of an electrode resulting from the passage of current.
 - *reference electrode - device for which the open circuit potential is constant under similar conditions of measurement.
 - * reverse-current switch - device that prevents the reversal of direct current through a metallic conductor.
 - *stray current - current flowing through paths other than the intended circuit.
 - *stray current corrosion - corrosion resulting from direct current flow through paths other than the intended circuit.
 - *structure-to-electrolyte voltage (also structure-to-soil potential or pipe-to-soil potential) - voltage difference between a buried metallic structure and the electrolyte, measured with a reference electrode in contact with the electrolyte.
 - *structure-to-structure voltage (also structure-to-structure potential) - difference in voltage between metallic structures in a common electrolyte.
 - *voltage - electromotive force, or a difference in electrode potentials, expressed in volts.

The proponent agency of this publication is the Office of the Chief of Engineers, United States Army. Users are invited to send comments and suggested improvements on DA Form 2028 (Recommended Changes to Publications and Blank Forms) direct to HQDA (DAEN-ECE-E), WASH DC 20314-1000.

By Order of the Secretary of the Army:

Official:

DONALD J. DELANDRO
Brigadier General, United States Army
The Adjutant General

JOHN A. WICKHAM, JR.
General, United States Army
Chief of Staff

Distribution:

Army: To be distributed in accordance with DA Form 12-34B, requirements for TM 5-800 Series:
Engineering and Design for Real Property Facilities