



Live Webinar: Dredging and Dredged Material Disposal

Course Number: EN-02-600W

PDH: 6

Approved for: AK, AL, AR, GA, IA, IL, IN, KS, KY, LA, MD, ME, MI, MN, MO, MS, MT, NC, ND, NE, NH, NJ, NM, NV, OH, OK, OR, PA, SC, SD, TN, TX, UT, VA, VT, WI, WV, and WY

New Jersey Professional Competency Approval #24GP00025600

North Carolina Approved Sponsor #S-0695

Maryland Approved Provider of Continuing Professional Competency

Indiana Continuing Education Provider #CE21800088

This document is the course text. You may review this material at your leisure before or after you purchase the course. In order to obtain credit for this course, complete the following steps:

- 1) Log in to My Account and purchase the course. If you don't have an account, go to New User to create an account.
- 2) After the course has been purchased, review the technical material and then complete the quiz at your convenience.
- 3) A Certificate of Completion is available once you pass the exam (70% or greater). If a passing grade is not obtained, you may take the quiz as many times as necessary until a passing grade is obtained (up to one year from the purchase date).

If you have any questions or technical difficulties, please call (508) 298-4787 or email us at admin@PDH-Pro.com.



CECW-EH-D Engineer Manual 1110-2-5025	Department of the Army U.S. Army Corps of Engineers Washington, DC 20314-1000	EM 1110-2-5025
	Engineering and Design DREDGING AND DREDGED MATERIAL DISPOSAL	
	Distribution Restriction Statement Approved for public release; distribution is unlimited.	

ENGINEERING AND DESIGN

**DREDGING AND DREDGED
MATERIAL DISPOSAL**

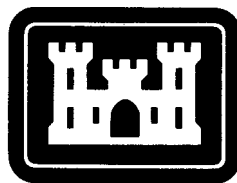

**DEPARTMENT OF THE ARMY
CORPS OF ENGINEERS
OFFICE OF THE CHIEF OF ENGINEERS**

DAEN-CWE-HD

Engineer Manual
No. 1110-2-5025

Engineering and Design
DREDGING AND DREDGED MATERIAL DISPOSAL

1. Purpose. This manual provides an inventory of the dredging equipment and disposal techniques used in the United States and provides guidance for activities associated with new work and maintenance projects. This manual further provides guidance on the evaluation and selection of equipment and evaluation of disposal alternatives.
2. Applicability. This manual is applicable to all field operating activities concerned with administering the Corps' dredging program.
3. Discussion. The engineering and design guidance discussed in this manual is primarily for projects that have been authorized and are in the preliminary design stages. However, much of the information is equally applicable to the preliminary engineering and design required during the authorization phase of dredging projects.

FOR THE COMMANDER:

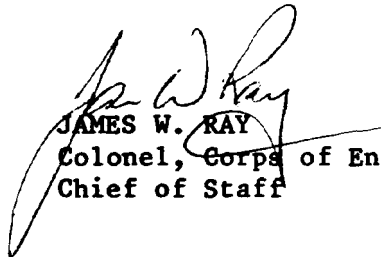
JAMES W. RAY
Colonel, Corps of Engineers
Chief of Staff

Engineering and Design
DREDGING AND DREDGED MATERIAL DISPOSAL

Table of Contents

	<u>Subject</u>	<u>Paragraph</u>	<u>Page</u>
CHAPTER 1.	INTRODUCTION		
	Purpose and Scope-----	1-1	1-1
	Applicability-----	1-2	1-1
	Reference-----	1-3	1-1
	Bibliography-----	1-4	1-2
	Background-----	1-5	1-2
	Considerations Associated With Dredging and Dredged Material Disposal-----	1-6	1-4
CHAPTER 2.	DESIGN CONSIDERATIONS		
	General-----	2-1	2-1
	Preliminary Data Collection-----	2-2	2-1
	Dredging Locations and Quantities-----	2-3	2-1
	Physical Properties of Sediments-----	2-4	2-2
	Selection of Dredging Equipment-----	2-5	2-5
	Disposal Alternatives-----	2-6	2-6
	Long-Range Studies-----	2-7	2-6
CHAPTER 3.	DREDGING EQUIPMENT AND TECHNIQUES		
	Purpose-----	3-1	3-1
	Factors Determining Equipment Selection--	3-2	3-1
	Hopper Dredges-----	3-3	3-3
	Cutterhead Dredges-----	3-4	3-7
	Dustpan Dredges-----	3-5	3-15
	Sidecasting Dredges-----	3-6	3-18
	Dipper Dredges-----	3-7	3-20
	Bucket Dredges-----	3-8	3-23
	Special-Purpose Dredge-----	3-9	3-26
	Summary of Dredge Operating Characteristics-----	3-10	3-28
	Locations of Dredges in the United States-----	3-11	3-28
	Agitation Dredging Techniques-----	3-12	3-31
	Advances in Dredging Technology-----	3-13	3-33
	Environmental Considerations-----	3-14	3-34

	<u>Subject</u>	<u>Paragraph</u>	<u>Page</u>
CHAPTER 4.	DISPOSAL ALTERNATIVES		
	Introduction-----	4-1	4-1
Section 1.	Evaluation of Dredged Material Pollution Potential Influence of Disposal Conditions on Environmental Impact-----	4-2	4-1
	Methods of Characterizing Pollution Potential-----	4-3	4-2
Section II.	Sediment Resuspension Due to Dredging Factors Influencing Dredging Turbidity---	4-4	4-4
Section III.	Open-Water Disposal Behavior of Discharges from Various Types of Dredges-----	45	4-6
	Dredged Material Dispersion at the Discharge Site-----	4-6	4-6
	Environmental Impacts in the Water Column-----	4-7	4-11
	Environmental Impacts on the Benthos-----	4-8	4-12
	Overview of Open-Water Disposal-----	4-9	4-16
Section IV.	Confined Dredged Material Disposal Containment Area Design-----	4-10	4-17
	Containment Area Operation and Management-----	4-11	4-24
	Productive Uses-----	4-12	4-27
	Environmental Considerations-----	4-13	4-28
Section V.	Habitat Development as a Disposal Alternative General Considerations for Habitat Development-----	4-14	4-29
	Marsh Habitat Development-----	4-15	4-31
	Upland Habitat Development-----	4-16	435
	Island Habitat Development-----	4-17	4-37
	Aquatic Habitat Development-----	4-18	4-40
APPENDIX A.	BIBLIOGRAPHY		A-1
APPENDIX B.	CHECKLIST FOR REQUIRED STUDIES		B-1

CHAPTER 1
INTRODUCTION

1-1. Purpose. This manual provides an inventory of the dredging equipment and disposal techniques used in the United States and provides guidance for activities associated with new work and maintenance projects. This manual also presents engineering and design guidance for use on both new work and maintenance dredging projects. The guidance is primarily for projects that have been authorized and are in the preliminary design stages. However, much of the information is equally applicable to the preliminary engineering and design required during the authorization phase of dredging projects. This manual further provides guidance on the evaluation and selection of equipment and evaluation of disposal alternatives.

1-2. Applicability. This EM is applicable to all field operating activities concerned with administering the Corps' dredging program.

1-3. References. The references listed below provide practical guidance to Corps personnel concerned with dredging and dredged material disposal.

a. ER 1110-2-1300, Government Estimates and Hired Labor Estimates for Dredging.

b. ER 1110-2-1404, Deep Draft Navigation Project Design.

c. EM 1110-2-1906, Laboratory Soils Testing.

d. EM 1110-2-1907, Soil Sampling.

e. EM 1125-2-312, Manual of Instructions for Hopper Dredge Operations and Standard Reporting Procedures.

f. WES TR D-77-9, Design and Construction of Retaining Dikes for Containment of Dredged Material.

g. WES TR DS-78-1, Aquatic Dredged Material Disposal Impacts.

h. WES TR DS-78-4, Water Quality Impacts of Aquatic Dredge Material Disposal (Laboratory Investigations).

i. WES TR DS-78-6, Evaluation of Dredged Material Pollution Potential.

j. WES TR DS-78-10, Guidelines for Designing, Operating, and Managing Dredged Material Containment Areas.

k. WES TR DS-78-11, Guidelines for Dewatering/Densifying Confined Dredged Material.

1. WES TR DS-78-12, Guidelines for Dredged Material Disposal Area Reuse Management.

- m. WES TR DS-78-13, Prediction and Control of Dredged Material Dispersion Around Dredging and Open-Water Pipeline Disposal Operations.

- n. WES TR DS-78-16, Wetland Habitat Development with Dredged Material: Engineering and Plant Propagation.

- o. WES TR DS-78-17, Upland Habitat Development with Dredged Material: Engineering and Plant Propagation.

- p. WES TR DS-78-18, Development and Management of Avian Habitat on Dredged Material Islands.

- q. WES TR DS-78-21, Guidance for Land Improvement Using Dredged Material.

The WES Technical Reports referenced above are available from the Technical Information Center, U. S. Army Engineer Waterways Experiment Station, P. O. Box 631, Vicksburg, MS 39180.

1-4. Bibliography. Bibliographic items are indicated throughout the manual by numbers (item 1, 2, etc.) that correspond to similarly numbered items in Appendix A. They are available for loan by request to the Technical Information Center Library, U. S. Army Engineer Waterways Experiment Station, P. O. Box 631, Vicksburg, MS 39180.

1-5. Background. The Corps of Engineers has been concerned with the development and maintenance of navigable waterways in the United States ever since Congressional authorization was received in 1824 to remove sandbars and snags from major navigable rivers. The Corp's dredging program involves the planning, design, construction, operation, and maintenance of waterway projects to meet navigation needs. The Corps' responsibility includes developing and maintaining the Nation's waterways and harbors, as well as maintaining a minimum dredging fleet to meet emergency, national defense, and national interest dredging requirements. The importance of the Corp's dredging program to the economic growth of the country is suggested by the fact that the total waterborne commerce of the United States continued its record-breaking advance during the 1970's. The viability of the economy of the United States is clearly dependent upon maintenance of the waterways, ports, and harbors for navigation. The Corp's annual dredging workload is approximately 287 million cu yd of material, including both maintenance and new work. The Corps accomplishes the majority (70 percent in FY 81) of its annual dredging workload by contracting privately owned equipment under competitive bidding procedures; it performs the remaining work using hired labor to operate Corps-owned dredges (item 5). An overview of the Corps' dredging program is shown in figure 1-1.

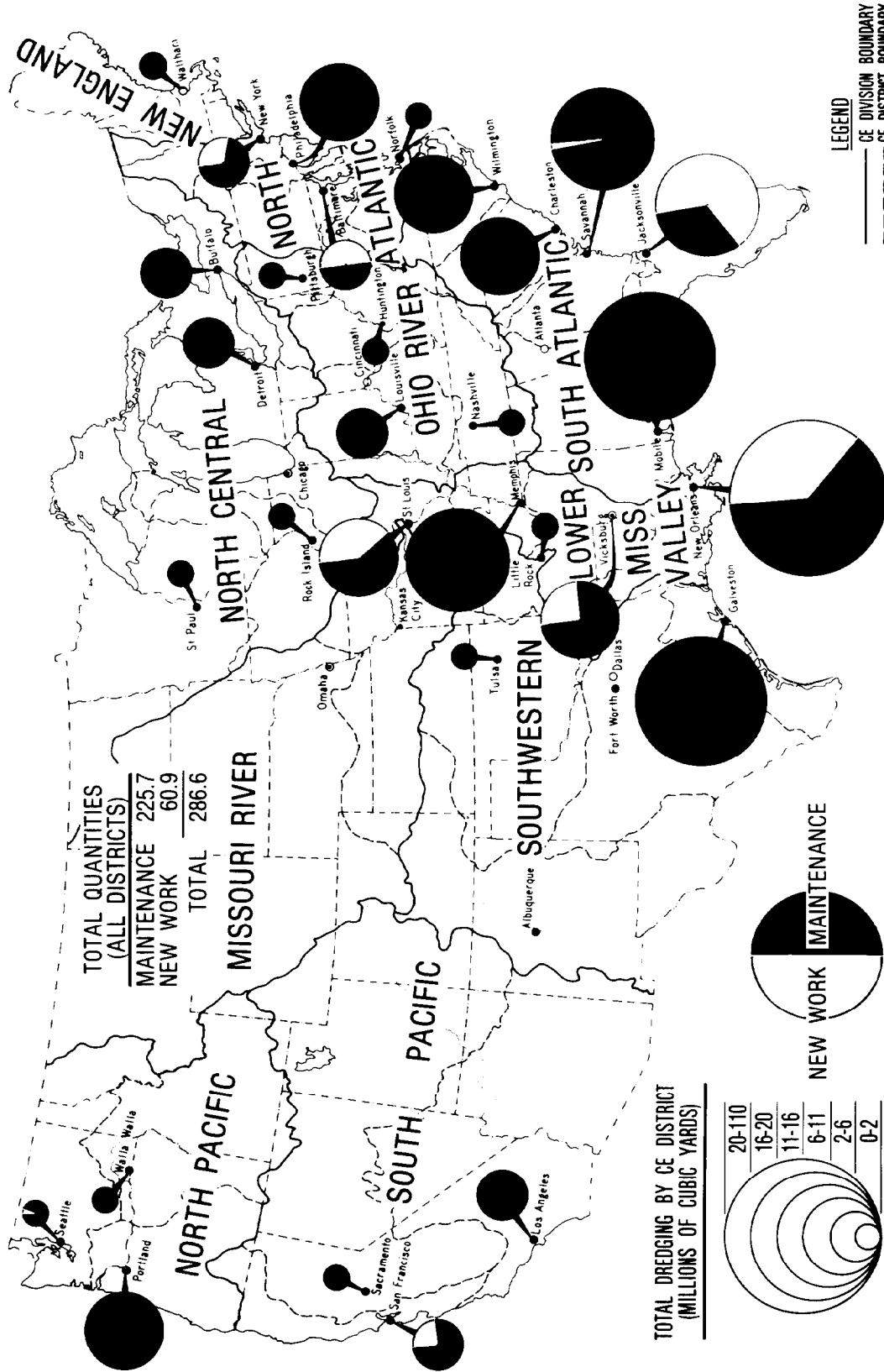

Figure 1-1. Corps' dredging program (FY 81).

1-6. Considerations Associated with Dredging and Dredged Material Disposal.
Some considerations associated with dredging and dredged material disposal are as follows:

- a. Selection of proper dredge plant for a given project.
- b. Determining whether or not there will be dredging of contaminated material.
- c. Adequate disposal facilities.
- d. Long-term planning for maintenance dredging projects.
- e. Characterization of sediments to be dredged to support an engineering design of confined disposal areas.
- f. Determining the levels of suspended solids from disposal areas and dredge operations.
- g. Disposal of contaminated sediments.
- h. Disposal in remote areas.
- i. Control of dredging operation to ensure environmental protection.
- j. Containment area management for maximizing storage capacity.

CHAPTER 2
DESIGN CONSIDERATIONS

2-1. General. A dredging and dredged material disposal operation requires consideration of both short- and long-term management objectives. The primary short-term objective of a dredging project is to construct or maintain channels for existing navigation needs but not necessarily to authorized project dimensions. This should be accomplished using the most technically satisfactory, environmentally compatible, and economically feasible dredging and dredged material disposal procedures. Long-term objectives concern the management and operation of disposal areas to ensure their long-term use. This chapter outlines the design consideration usually needed to meet the objectives of a dredging project.

2-2. Preliminary Data Collection. In order to gather the data required for a dredging and dredged material disposal project, it is necessary to do the following:

- a. Analyze dredging location and quantities to be dredged, considering future needs.
- b. Determine the physical and chemical characteristics of the sediments.
- c. Evaluate potential disposal alternatives.
- d. Identify pertinent social, environmental, and institutional factors.
- e. Evaluate dredge plant requirements.

2-3. Dredging Locations and Quantities.

a. Dredging locations and the quantities of material to be dredged are two of the most important considerations in planning dredging projects. Since disposal of dredged material is usually the major dredging problem, it is essential that long-term projections be made for disposal requirements of each project. Records should be kept of quantities dredged and maintenance interval(s) to forecast future dredging and disposal requirements.

b. Hydrographic surveys are the principal dredged contract management tool of the Corps. Hydrographic surveys should be made prior to dredging to determine existing depths within the project area and after dredging to determine the depths that were attained as a result of the dredging operation. Each district should have the capability, either in-house or by contract, to make accurate, timely, and repeatable hydrographic surveys. To ensure accuracy, quantity calculations must be made from survey data gathered in a timely manner using proper equipment and based upon precisely established horizontal and vertical controls. Direct tide level readings must be made at the site of the work to eliminate gross errors in quantity calculations. Quantity measurement methods must be fully consistent

between work per formed by contract and work per formed by hired labor.

2-4. Physical Properties of Sediments. In planning any dredging operation which constitutes a specialized problem in earthmoving or excavation, it is essential that field measurements and computations be made to determine the location, characteristics, and quantities of material to be removed. The characteristics of the dredged material determine dredge plant and, to some extent, disposal requirements. Refer to Chapter 4 for specific characterization tests required for evaluation and design of disposal alternatives for dredged material.

a. Sampling. Sediment samples should be taken of the material above the depth to which removal will be credited. This should be done concurrent with the pre-dredge survey. For maintenance dredging of a recurring nature, samples will be taken before each dredging until the characteristics of the sediments are well known. For subsequent dredging, a small number of samples will be taken to identify and changes in sediment characteristics. Normally the sediment sampling depth will be the authorized project depth plus an allowable tolerance (usually 2 ft) to compensate for the inherent inaccuracies of the dredging process. The number of sediment samples taken should be sufficient to obtain accurate information regarding the characteristics of the material to be dredged. Samples in soft materials can be obtained by push tube or grab samplers.

(1) Tube sampling.

(a) A tube sampler is an open-ended tube that is thrust vertically into the sediment deposit to the depth desired. The sampler is withdrawn from the deposit with the sample retained within the tube. Differences among tube samplers relate to tube size, tube wall thickness, type of penetrating nose, head design including valve, and type of driving force. Tube samplers (also called harpoon samplers) are available with adjustable weights in the range of from 17 to 77 lb and with fixed weights in excess of 90 lb. The amount of weight required depends upon deposit texture and required depth of penetration.

(b) The split barrel sample spoon (also known as split-spoon sampler) is capable of penetrating hard sediments, provided sufficient force is applied to the driving rods. The sampler is thrust into the deposit by the hammering force exerted on rods connected to the head. During retrieval, the sample is retained within the barrel by a flap. The nose and head are separated from the barrel in order to transfer the sample to a container. Refer to EM 1110-2-1907 for more information on soil sampling.

(2) Grab sampling. A grab sampler consists of a scoop or bucket container that bites into the soft sediment deposit and encloses the sample. Grab samplers are used primarily to sample surface materials, with depth of penetration being 12 in. or less. Grab samplers are easy and inexpensive to obtain and may be sufficient to characterize sediment for routine maintenance dredging. Grab sampling may indicate relatively homogeneous sediment composition, segregated pockets or coarse- and fine-grained sediment, and/or mixtures. If segregated pockets are present, samples should be taken at

a sufficient number of locations in the channel to adequately define spatial variations in the sediment character and quantities of each material.

(3) New work. Samples taken by conventional boring techniques are normally required for new work dredging. Samples should be taken from within the major zones of spatial variation in sediment type or along the proposed channel center line at constant spacing to define stratification within the material to be dredged and to obtain representative samples. Borings are required for new projects and should be advanced below the depth of anticipated dredging. The relative density of sands can be determined by driving a split-spoon sampler and recording the number of blows required to penetrate each foot of sand. Refer to EM 1110-2-1907 for information on conventional soil sampling methods and standard split-spoon penetration tests. Information on the soil above and below the authorized new work depth is needed to properly design the channel slopes. It is essential to obtain the characteristics of the material to be dredged to preclude determination of unsuitable dredge plant, unrealistic production and cost estimates, etc. Pertinent information regarding sediment samplers is summarized in table 2-1.

b. Laboratory Testing. Laboratory tests are required to provide data for determining the proper dredge plant, evaluating and designing disposal alternatives, designing channel slopes and retention dikes, and estimating long-term storage capacity for confined disposal areas. The tests discussed below are to be used to characterize the material to be dredged so that a proper dredge plant can be selected. Specific tests for evaluation and design of disposal alternatives are discussed in Chapter 4. The required laboratory tests are essentially standard tests and generally follow procedures found in EM 1110-2-1906. The extent of the testing program is project-dependent: fewer tests are required when dealing with a relatively homogeneous material and/or when data are available from previous tests and experience, as is frequently the case in maintenance dredging; for new work projects and unusual maintenance dredging projects where considerable variation in sediment properties is apparent from samples, more extensive laboratory testing programs are required. Laboratory tests should always be performed on representative sediment samples. Tests required on fine-grained sediments (those of which more than half pass through a No. 40 sieve) include natural water content, plasticity analyses (Atterberg limits), and specific gravity. The coarse-grained sediments (those of which more than half are retained on a No. 40 sieve) require only grain size analyses and in situ density determinations. These tests are described below.

(1) Natural water content test. Natural water content refers to the in situ water content of the sediment. It is used to determine the in situ void ratio and in situ density of fine-grained sediments. Water content determinations should be made on representative samples from borings and grab samples of fine-grained sediment obtained during field investigation. Fine-grained sediments do not drain rapidly; thus, representative samples taken from borings and grab samples are considered to represent in situ water contents. Detailed test procedures for determining the water content are found in Appendix I of EM 1110-2-1906.

Table 2-1. Summary of Sediment Sampling Equipment

Sampler	Weight	Remarks
Peterson	39-93 lb	Samples 144-in. ² area to a depth of up to 12 in., depending on sediment texture
Shipek	150 lb	Samples 64-in. ² area to a depth of approximately 4 in.
Ekman	9 lb	Suitable only for very soft sediments
Ponar	45-60 lb	Samples 81-in. ² area to a depth of less than 12 in. Ineffective in hard clay
Drag Bucket	Varies	Skims an irregular slice of sediment surface. Available in assorted sizes and shapes
Phleger Tube (gravity corer)	Variable : 17-77 lb; fixed in excess of 90 lb	Shallow core samples may be obtained by self-weight penetration and/or pushing from boat. Depth of penetration dependent on weight and sediment texture
Conventional Soil Samplers	Refer to EM 1110-2-1907	Conventional soil samplers may be employed using barge- or boat-mounted drilling equipment. Core samples attainable to full depth of dredging

25 Mar 83

(2) Plasticity analyses. Plasticity analyses (Atterberg limits) should be performed on the separated fine-grained fraction (passing the No. 40 sieve) of sediment samples. A detailed explanation of the tests required to evaluate the plasticity of sediments is presented in Appendix III of EM 1110-2-1906. Samples should be classified according to the Unified Soil Classification System (USCS) (item 12).

(3) Specific gravity test. Values for the specific gravities of solids in fine-grained sediments are required for determining void ratios and in situ densities. Procedures for conducting the specific gravity test are given in Appendix IV of EM 1110-2-1906.

(4) Grain size analyses. Grain size analyses are required only on the coarse-grained fraction of samples. Grain size analyses should follow the procedures contained in Appendix V of EM 1110-2-1906.

c. In situ density. In situ density is used to evaluate dredgability to sediments and aid in equipment selection, to estimate production rates, and to estimate volume required for storage in confined disposal areas. In situ density can be estimated from field investigations of sediments or from laboratory test data using geotechnical engineering formulas. Refer to Appendix II of EM 1110-2-1906 for guidance in estimating in situ density from laboratory tests. For sand sediments, relative density has a decisive influence on the selection of equipment for dredging. The relative density of sands can be estimated from standard split-spoon penetration tests (para 2-4a). Table 2-2 presents estimates of relative density of sands based on standard penetration tests. Where no field tests are performed on coarse-grained materials (i.e. sand, gravel, etc.,) the material in its densest state based on laboratory tests will be considered comparable to its in situ condition.

Table 2-2. Relative Density of Sands According to Results of Standard Penetration Tests

<u>No. of Blows/ft</u>	<u>Relative Density</u>
0-4	Very loose
4-10	Loose
10-30	Medium
30-50	Dense
Over 50	Very dense

2-5. Selection of Dredging Equipment. Most Corps dredging is performed by private industry under contract, and the specifications should not be written such that competitive bidding is restricted. However, in certain situations limitations may be placed on the equipment to be used to minimize the environmental impact of the dredging and disposal operation. In cases where available upland containment areas are small, the size of the dredge should be restricted to minimize stress on the containment area dikes and to provide adequate retention time for sedimentation to minimize

excessive suspended solids in the weir effluent. Environmental protection is adequate justification for carefully controlling the selection and use of dredging equipment. The dredging of contaminated sediments requires careful assessment of the dredging operation. The information presented in Chapters 3 and 4 will provide guidance for proper equipment selection based on the materials to be dredged, dredging environment, contamination level of sediments, transport and disposal requirements, and production requirements.

2-6. Disposal Alternatives. The major considerations in selecting disposal alternatives are the environmental impact and the economics of the disposal operation. Much of the recent knowledge concerning dredged material disposal was gained as a result of the Dredged Material Research Program (DMRP) conducted by the U.S. Army Engineer Waterways Experiment Station (WES) and reported in WES Technical Reports. The major objectives of the DMRP were to provide definitive information on the environmental impact of dredging and dredged material disposal operations and to develop new or improved dredged material disposal practices. The research was conducted on a national basis, excluding no major types of dredging activity or region or environmental setting. It produced methods for evaluating the physical, chemical, and biological impacts of a variety of disposal alternatives in water, on land, or in wetland areas, as well as tested, viable, cost-effective methods and guidelines for reducing the impacts of conventional disposal alternatives. Summary reports produced under this program are listed in para 1-3, and a detailed discussion of disposal alternatives is presented in Chapter 4. Two fundamental conclusions were drawn from the results of the DMRP concerning disposal of dredged material: (1) no single disposal alternative can be presumed most suitable for a region, a type of dredged material, or a group of projects before it has been tested, and (2) environmental considerations make necessary long-range regional planning for lasting, effective solutions to disposal concerns. There is no inherent effect or characteristic of a disposal alternative that can rule it out of consideration from an environmental standpoint before specific on-site evaluation. This holds true for open-water disposal, confined upland disposal, habitat development, or any other alternative. Case-by-Case project evaluations are time-consuming and expensive and may seriously complicate advanced planning and funding requests. Nevertheless, from a technical point of view, situations can be envisioned where tens of millions of dollars may have been or could be spent for disposal alternatives that contribute to adverse environmental effects rather than reduce them. Also, easily obtained beneficial impacts should not be overlooked. No category of disposal alternative is without environmental risk or offers the soundest environmental protection or reflects the best management practice; therefore, all disposal alternatives should be fully investigated during the planning process and treated on an equal basis until a final decision can be made based on all available facts. It is hypothesized that all alternatives could be considered to dispose of even the most highly contaminated dredged material if a plan could be devised for management that was adequate and legally acceptable under domestic regulations and international treaty.

2-7. Long-Range Studies. Dredging and disposal activities cannot be

designed independently for each of several projects in a given area. While each project may require different specific solutions, the interrelationships among them must be determined. Thought must also be given to changing particular dredging techniques and disposal alternatives as conditions change. Long-range regional dredging and disposal management plans not only offer greater opportunities for environmental protection and effective use of dredging equipment at reduced project cost, but they also meet with greater public acceptance once they are agreed upon. Long-range plans must reflect sound engineering design, consider and minimize any adverse environmental impacts, and be operationally implementable.

CHAPTER 3
DREDGING EQUIPMENT AND TECHNIQUES

3-1. Purpose. This chapter includes a description of the dredging equipment and techniques used in dredging activities in the United States and presents advantages and limitations for each type of dredge. Guidance is provided for selection of the best dredging equipment and techniques for a proposed dredging project to aid in planning and design.

3-2. Factors Determining Equipment Selection.

a. The types of equipment used, by both the Corps and private industry, and the average annual amount of dredging associated with each type are shown in Figure 3-1. The dredging methods employed by the Corps vary considerably throughout the United States. Principal types of dredges include hydraulic pipeline types (cutterhead, dustpan, plain suction, and sidecaster), hopper dredges, and clamshell dredge. The category of "other" dredges in Figure 3-1 includes dipper, ladder, and special purpose dredges. However, there are basically only three mechanisms by which dredging is actually accomplished:

(1) Suction dredging. Removal of loose materials by dustpans, hoppers, hydraulic pipeline plain suction, and sidecasters, usually for maintenance dredging projects.

(2) Mechanical dredging. Removal of loose or hard, compacted materials by clamshell, dipper, or ladder dredges, either for maintenance or new work projects.

(3) A combination of suction and mechanical dredging. Removal of loose or hard, compacted materials by cutterheads, either for maintenance or new work projects.

b. Selection of dredging equipment and method used to perform the dredging will depend on the following factors:

- (1) Physical characteristics of material to be dredged.
- (2) Quantities of material to be dredged.
- (3) Dredging depth.
- (4) Distance to disposal area.
- (5) Physical environment of and between the dredging and disposal areas.
- (6) Contamination level of sediments.
- (7) Method of disposal.

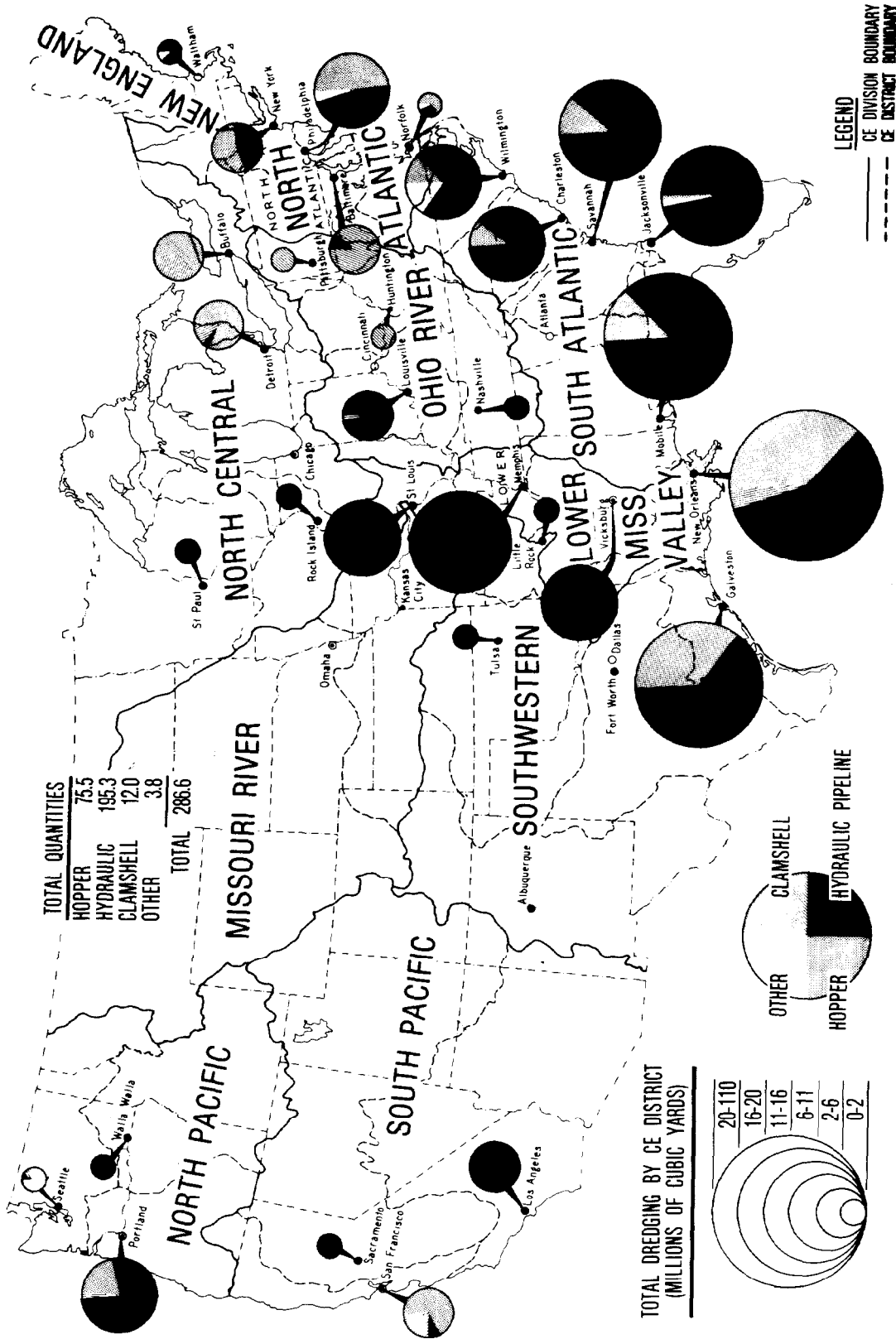

Figure 3-1. Types of dredges used and estimated quantities to be dredged by each District (FY 81).

(8) Production required.

(9) Type of dredges available.

3-3. Hopper Dredges.

a. General. Hopper dredges are self-propelled seagoing ships of from 180 to 550 ft in length, with the molded hulls and lines of ocean vessels (fig. 3-2). They are equipped with propulsion machinery, sediment containers (hoppers), dredge pumps, and other special equipment required to perform their essential function of removing material from a channel bottom or ocean bed. Hopper dredges have propulsion power adequate for required free-running speed and dredging against strong currents and excellent maneuverability for safe and effective work in rough, open seas. Dredged material is raised by dredge pumps through dragarms connected to drags in contact with the channel bottom and discharged into hoppers built in the vessel. Hopper dredges are classified according to hopper capacity: large-class dredges have hopper capacities of 6000 cu yd or greater, medium-class hopper dredges have hopper capacities of 2000 to 6000 cu yd, and small-class hopper dredges have hopper capacities of from less than 2000 to 500 cu yd. During dredging operations, hopper dredges travel at a ground speed of from 2 to 3 mph and can dredge in depths from about 10 to over 80 ft. They are equipped with twin propellers and twin rudders to provide the required maneuverability. Table 3-1 gives available specifications for all vessels in the Corps hopper dredge fleet.

b. Description of Operation.

(1) General. Operation of a seagoing hopper dredge involves greater effort than that required for an ordinary ocean cargo vessel, because not only the needs of navigation of a self-propelled vessel but also the needs associated with its dredging purposes must be satisfied. Dredging is accomplished by progressive traverses over the area to be dredged. Hopper dredges are equipped with large centrifugal pumps similar to those employed by other hydraulic dredges. Suction pipes (dragarms) are hinged on each side of the vessel with the intake (drag) extending downward toward the stern of the vessel. The drag is moved along the channel bottom as the vessel moves forward at speeds up to 3 mph. The dredged material is sucked up the pipe and deposited and stored in the hoppers of the vessel. Once fully loaded, hopper dredges move to the disposal site to unload before resuming dredging. Unloading is accomplished either by opening doors in the bottoms of the hoppers and allowing the dredged material to sink to the open-water disposal site or by pumping the dredged material to upland disposal sites. Because of the limitations on open-water disposal, most hopper dredges have direct pumpout capability for disposal in upland confined sites. Before there were environmental restrictions, hopper dredges were operated with the primary objective of obtaining the maximum economic load; i.e., removing the maximum quantity of material from the channel prism in the shortest pumping time during a day's operation.

(2) Hopper dredging is accomplished by three methods: (a) pumping past overflow, (b) agitation dredging, and (c) pumping to overflow. The

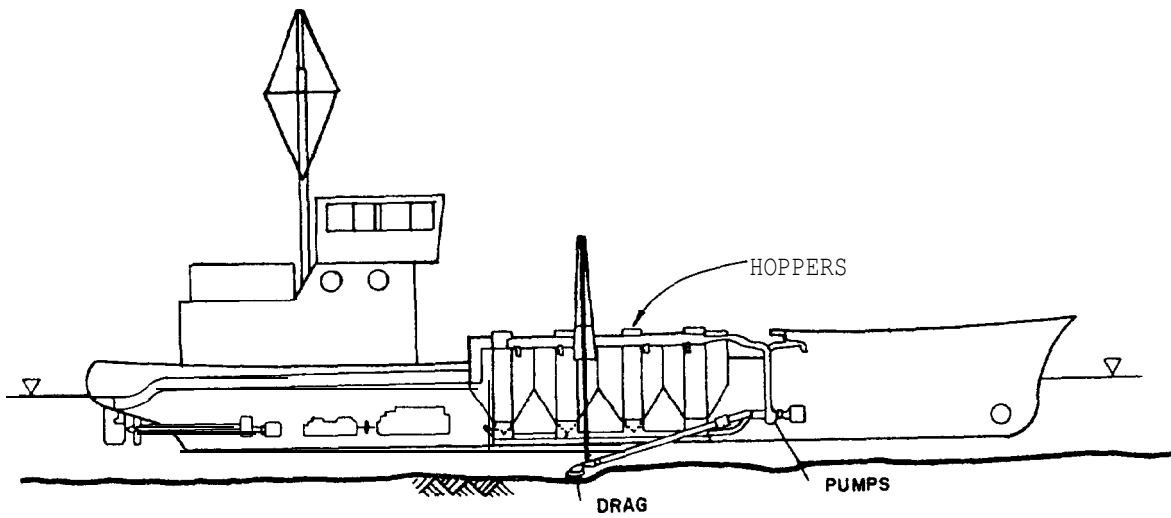

Figure 3-2. Self-propelled seagoing hopper dredge.

Table 3-1. Pertinent Characteristics of Corps of Engineers Hopper Dredges.

Name	Hopper Capacity cu yd	Dredged Pumps		Light Loaded Speed mph	Hull		Draft Loaded	Dredging Depth Max	Vertical Clearance Required	Regional Location	Special Capability
		Number hp	Size Drive		Material Length	Beam Depth					
BIDDLE	3060	2 1150	28" Electric	17.3 14.4	Steel 351'9"	60'0" 30'0"	24'9"	62'	83'	West Coast	None
ESSAYONS	6000	-- ^a	--	15.4	Steel 350'	68' 35'	27'	80'	--	Gulf Coast	Direct pumpout
HAINS	855	1 410	20" Electric	14.1 13.1	Steel 215'10"	40'4" 15'6"	13'0"	36'	69'	Great Lakes	Direct pumpout Sidecasting
WHEELER	8400	--	--	16.1	Steel 409'	78' 39'	29'5"	80'	--	Gulf Coast	Direct pumpout
YAQUINA	825	--	--	11.5	Steel 200'	58' 17'	12'	45'	--	West Coast	Direct pumpout
MACFARLAND	3140	2 1867	34" Electric	15.4 14.0	Steel 319'8"	72'0" 33'	22'0"	55'	90'	East Coast	Direct pumpout Sidecasting
MARKHAM	2780	2 650	23" Electric	16.7 14.4	Steel 339'6"	62'0" 28'0"	19'4"	45'	90'	Great Lakes	Direct pumpout
PACIFIC	500	1 340	18" Electric	11.5 9.8	Steel 180'3"	38'0" 14'0"	12'0"	45'	70'	West Coast	None

^aData unavailable.

use of these methods is controlled to varying degrees by environmental legislation and the water quality certification permits required by the various states in which dredging is being accomplished. The environmental effects of these methods must be assessed on a project-by-project basis. If the material being dredged is clean sand, the percentage of solids in the overflow will be small and economic loading may be achieved by pumping past overflow. When contaminated sediments are to be dredged and adverse environmental effects have been identified, pumping past overflow is not recommended. In such cases, other types of dredges may be more suitable for removing the contaminated sediments from the channel prism. If hopper dredges are not allowed to pump past overflow in sediments that have good settling properties, the cost of dredging increases. The settling properties of silt and clay sediments may be such that only a minimal load increase would be achieved by pumping past overflow. Economic loading, i.e. the pumping time required for maximum production of the hopper dredge, should be determined for each project. These determinations, along with environmental considerations, should be used to establish the operation procedures for the hopper dredge.

(3) Agitation dredging. Agitation dredging is a process which intentionally discharges overboard large quantities of fine-grained dredged material by pumping past overflow, under the assumption that a major portion of the sediments passing through the weir overflow will be transported and permanently deposited outside the channel prism by tidal, river, or littoral currents. Agitation dredging should be used only when the sediments dredged have poor settling properties, when there are currents in the surrounding water to carry the sediments from the channel prism, and when the risk to environmental resources is low. Favorable conditions may exist at a particular project only at certain times of the day, such as at ebb tides, or only at such periods when the streamflow is high. To use agitation dredging effectively requires extensive studies of the project conditions and definitive environmental assessments of the effects. Agitation dredging should not be performed while operating in slack water or when prevailing currents permit redeposit of substantial quantities of the dredged material in the project area or in any other area where future excavation may be required. Refer to para 3-12 for more information on this topic.

(4) Refer to ER 1125-2-312 for instructions for hopper dredge operations.

c. Application. Hopper dredges are used mainly for maintenance dredging in exposed harbors and shipping channels where traffic and operating conditions rule out the use of stationary dredges. The materials excavated by hopper dredges cover a wide range of types, but the hopper dredge is most effective in the removal of material which forms shoals after the initial dredging is completed. While specifically designed drags are available for use in raking and breaking up hard materials, hopper dredges are most efficient in excavating loose, unconsolidated materials. At times, hopper dredges must operate under hazardous conditions caused by fog, rough seas, and heavy traffic encountered in congested harbors.

d. Advantages. Because of the hopper dredge's design and method of

operation, the self-propelled seagoing hopper dredge has the following advantages over other types of dredges for many types of projects:

- (1) It is the only type of dredge that can work effectively, safely, and economically in rough, open water.
- (2) It can move quickly and economically to the dredging project under its own power.
- (3) Its operation does not interfere with or obstruct traffic.
- (4) Its method of operation produces usable channel improvement almost as soon as work begins. A hopper dredge usually traverses the entire length of the problem shoal, excavating a shallow cut during each passage and increasing channel depth as work progresses.
- (5) The hopper dredge may be the most economical type of dredge to use where disposal areas are not available within economic pumping distances of the hydraulic pipeline dredge.

e. Limitations. The hopper dredge is a seagoing self-propelled vessel designed for specific dredging projects. The following limitations are associated with this dredge:

- (1) Its deep draft precludes use in shallow waters, including barge channels.
- (2) It cannot dredge continuously. The normal operation involves loading, transporting material to the dump site, unloading, and returning to the dredging site.
- (3) The hopper dredge excavates with less precision than other types of dredges.
- (4) Its economic load is reduced when dredging contaminated sediments since pumping past overflow is generally prohibited under these conditions and low-density material must be transported to and pumped into upland disposal areas.
- (5) It has difficulty dredging side banks of hardpacked sand.
- (6) The hopper dredge cannot dredge effectively around piers and other structures.
- (7) Consolidated clay material cannot be economically dredged with the hopper dredge.

3-4. Cutterhead Dredges.

a. General. The hydraulic pipeline cutterhead suction dredge is the most commonly used dredging vessel and is generally the most efficient and versatile (fig. 3-3). It performs the major portion of the dredging

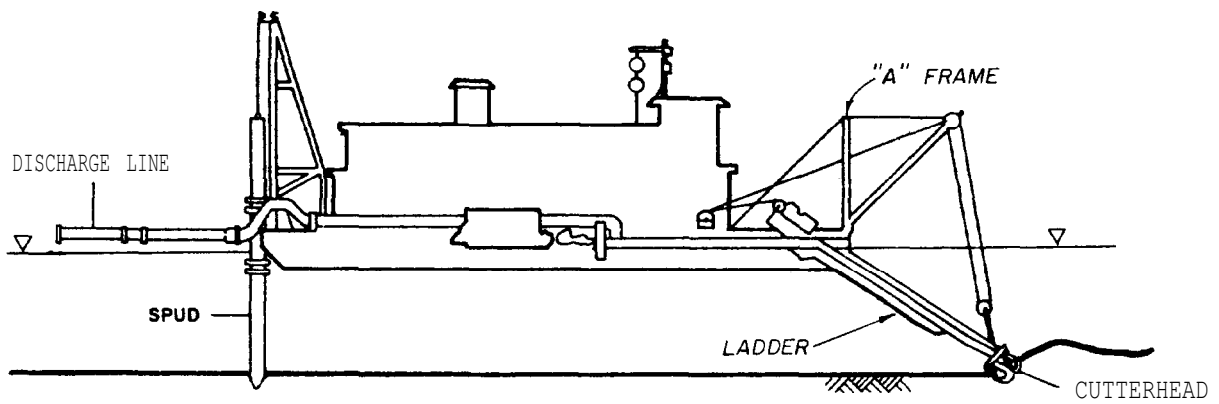
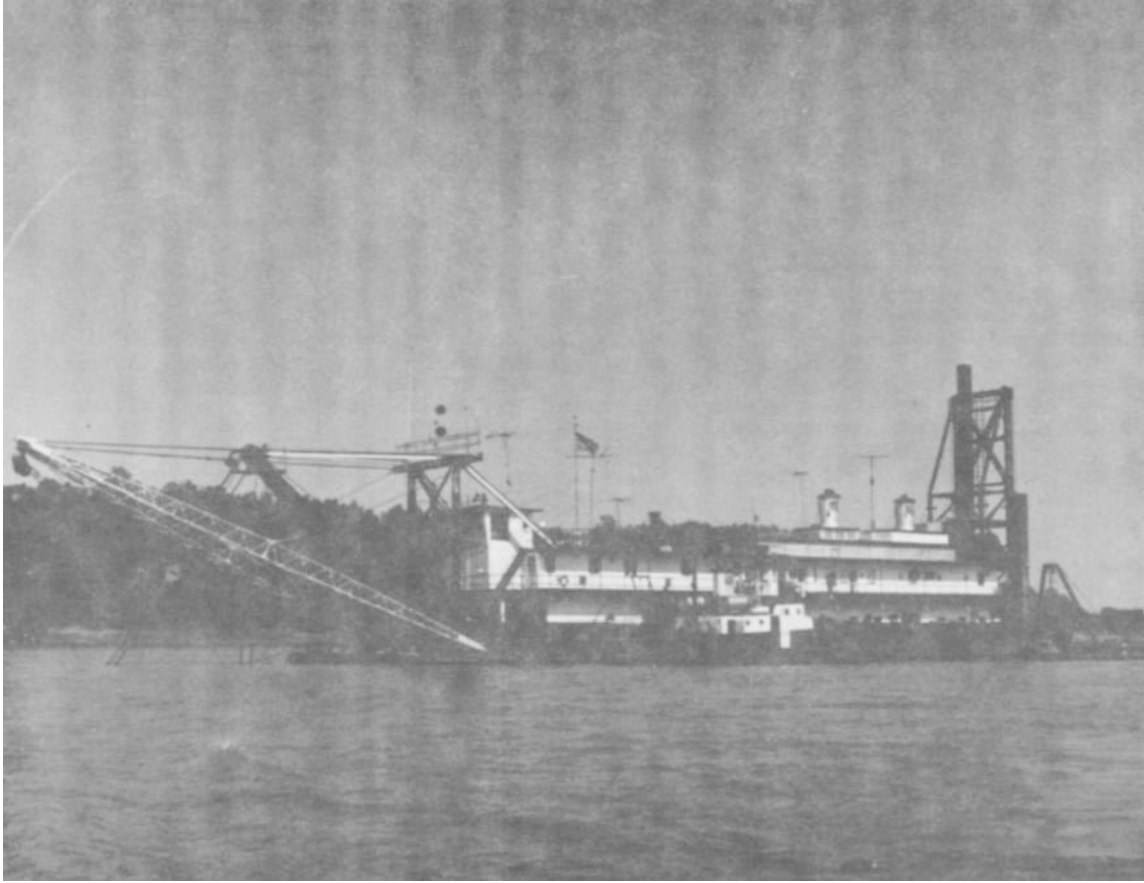

Figure 3-3. Hydraulic pipeline cutterhead dredge.

25 Mar 83

workload in the United States. Because it is equipped with a rotating cutter apparatus surrounding the intake end of the suction pipe, it can efficiently dig and pump all types of alluvial materials and compacted deposits, such as clay and hardpan. This dredge has the capability of pumping dredged material long distances to upland disposal areas. Slurries of 10 to 20 percent solids (by dry weight) are typical, depending upon the material being dredged, dredging depth, horsepower of dredge pumps, and pumping distance to disposal area. If no other data are available, a pipeline discharge concentration of 13 percent by dry weight (145 ppt) should be used for design purposes. Pipeline discharge velocity, under routine working conditions, ranges from 15-20 ft/sec. Table 3-2 presents theoretical pipeline discharge rates as functions of pipeline discharge velocities for dredges ranging in sizes from 8 to 30 in.

Table 3-2. Suction Dredge Pipeline Discharge Rates,^a
cu ft/sec

Discharge Velocity ft/sec	Discharge Pipe Diameter			
	a in.	18 in.	24 in.	30 in.
10	3.5	17.7	31.4	49.1
15	5.2	26.5	47.1	73.6
20	7.0	35.3	62.8	98.1
25	8.7	44.2	78.5	122.7

^aDischarge rate = pipeline area x discharge velocity.

Production rate is defined as the number of cubic yards of in situ sediments dredged during a given period and is usually expressed in cu yd/hr. Production rates of dredges vary according to the factors listed above and other operational factors that are not necessarily consistent between dredges of the same size and type. For example, a 16-in. dredge should produce between 240 and 875 cu yd of dredged material per hour, and a 24-in. dredge should produce between 515 and 1615 cu yd per hour. The range for typical cutterhead production as a function of dredge size is shown in figure 3-4. This figure illustrates the wide range of production for dredges of the same size. The designer can refer to figure 3-5, which shows the relationships among solids output, dredge size, and pipeline length for various dredging depths, as a preliminary selection guide for the size of dredge required for a given project. This is only a rough guide, and accurate calculations based not only on the type of material to be dredged but on the power available and other considerations should be completed before a final engineering recommendation can be made. The designer should refer to the data available from ENG Form 4267, "Report of Operations-- Pipeline, Dipper, or Bucket Dredges," for use in estimating production rates, effective working time, etc. These data on past dredging projects are available in the Construction-Operation Divisions of the Districts. Specifications and dimensions for several cutterhead dredges ranging in pipe diameter from 6 to 30 in. are presented in table 3-3.

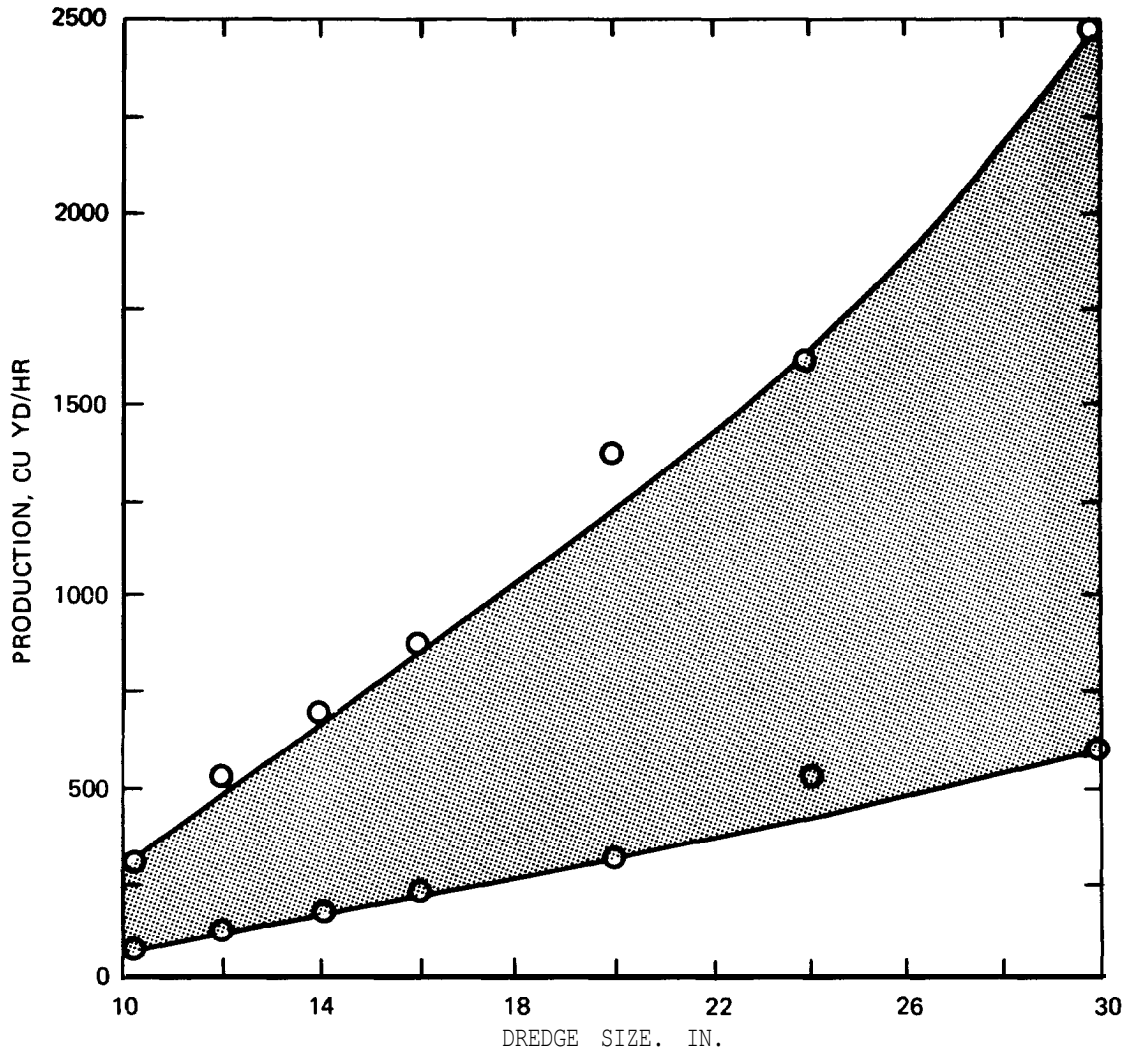

Figure 3-4. Typical cutterhead dredge production according to dredge size.

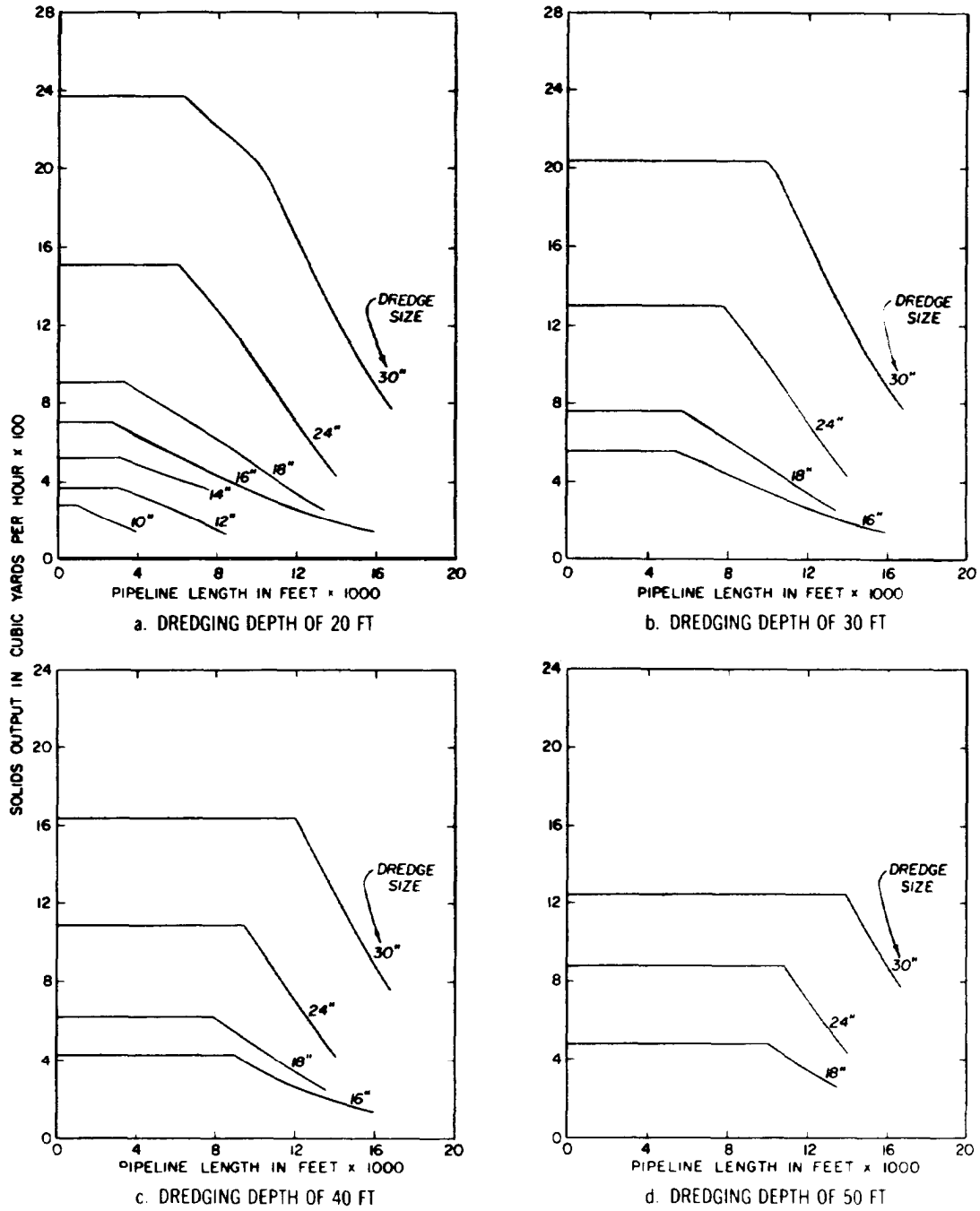

Figure 3-5. Relationships among solids output, dredge size, and pipeline length for various dredging depths- (WES TR DS-78-10)

Table 3-3. Specifications for Typical Dustpan and Cutterhead Dredges.

Dredge Type	Pipeline Diameter in.	Weight tons	Length ft	Width ft	Height ft	Draft in.	Freeboard in.	Dredge Pumps		Production Rate cu yd/hr	Dredging Depth ft	Depth of Single Pass Excavation in.		
								No.	hp					
Dustpan	32	--	244	50	60	60	48	1	2100	38	Steam	3500	60	60
Cutterhead	6	18.5	44	11	20	34	14	1	175	8	Diesel	25-95	12	18
Cutterhead	8	18.5	44	11	20	35	13	1	175	8	Diesel	45-105	12	18
Cutterhead	10	72.5	90	17	33	43	17	1	335	12	Diesel	60-300	25	18
Cutterhead	12	73.5	90	20	33	42	18	1	520	14	Diesel	120-540	25	18
Cutterhead	14	87	95	20	33	43	17	1	520	16	Diesel	160-700	25	21
Cutterhead	16	166	130	28	55	55	17	1	1125	18	Diesel	240-875	40	21
Cutterhead	20	316	180	32	70	54	42	1	1700	24	Diesel	310-1365	50	24
Cutterhead	24	326	185	32	70	56	40	1	2250	24	Diesel	515-1615	50	30
Cutterhead	30	350	225	36	67	60	36	1	3600	30	Diesel	575-2500	50	36

b. Description of Operation. The cutterhead dredge is generally equipped with two stern spuds used to hold the dredge in working position and to advance the dredge into the cut or excavating area. During operation, the cutterhead dredge swings from side to side alternately using the port and starboard spuds as a pivot, as shown in figure 3-6. Cables attached to anchors on each side of the dredge control lateral movement. Forward movement is achieved by lowering the starboard spud after the port swing is made and then raising the port spud. The dredge is then swung back to the starboard side of the cut centerline. The port spud is lowered and the starboard spud lifted to advance the dredge. The excavated material may be disposed of in open water or in confined disposal areas located upland or in the water. In the case of open-water disposal, only a floating discharge pipeline, made up of sections of pipe mounted on pontoons and held in place by anchors, is required. Additional sections of shore pipeline are required when upland disposal is used. In addition, the excavated materials may be placed in hopper barges for disposal in open water or in confined areas that are remote from the dredging area. In cutterhead dredging, the pipeline transport distances usually range up to about 3 miles. For commercial land reclamation or fill operations, transport distances are generally longer, with pipeline lengths reaching as far as 15 miles, for which the use of multiple booster pumps is necessary.

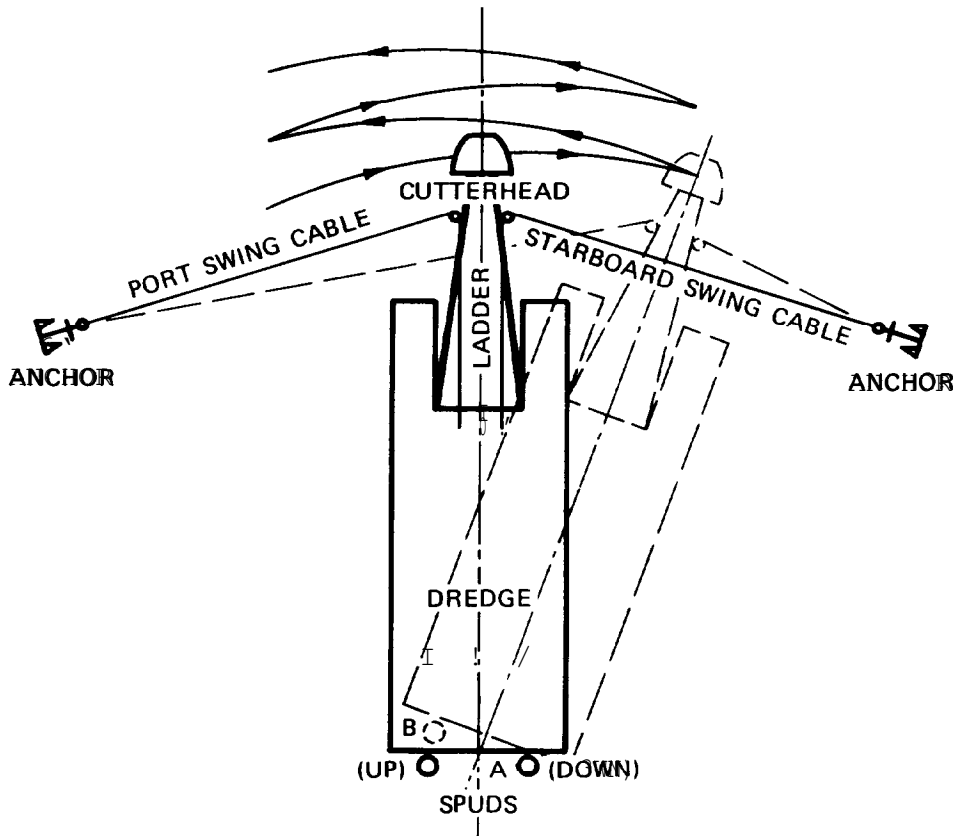

Figure 3-6. Operation of a cutterhead dredge (viewed from above).

c. Application. Although the cutterhead dredge was developed to loosen up densely packed deposits and eventually cut through soft rock, it can excavate a wide range of materials including clay, silt, sand, and gravel. The cutterhead, however, is not needed in maintenance dredging of most materials consisting of clay, silt, and fine sand because in these materials, rotation of the cutterhead produces a turbidity cloud and increases the potential for adverse environmental impacts. Common practice is to use the cutterhead whether it is needed or not. When the cutterhead is removed, cutterhead dredges become in effect plain suction dredges. The cutterhead dredge is suitable for maintaining harbors, canals, and outlet channels where wave heights are not excessive. A cutterhead dredge designed to operate in calm water will not operate offshore in waves over 2-3 ft in height; the cutterhead will be forced into the sediment by wave action creating excessive shock loads on the ladder. However, a cutterhead dredge designed to operate offshore can operate in waves up to about 6 ft.

d. Advantages. The cutterhead dredge is the most widely used dredge in the United States because of the following advantages:

(1) Cutterhead dredges are used on new work and maintenance projects and are capable of excavating most types of material and pumping it through pipelines for long distances to upland disposal sites.

(2) The cutterhead operates on an almost continuous dredging cycle, resulting in maximum economy and efficiency.

(3) The larger and more powerful machines are able to dredge rocklike formations such as coral and the softer types of basalt and limestone without blasting.

e. Limitations. The limitations on cutterhead dredges are as follows:

(1) The cutterhead dredges available in the United States have limited capability for working in open-water areas without endangering personnel and equipment. The dredging ladder on which the cutterhead and suction pipe are mounted is rigidly attached to the dredge; this causes operational problems in areas with high waves.

(2) The conventional cutterhead dredges are not self-propelled. They require the mobilization of large towboats in order to move between dredging locations.

(3) The cutterhead dredge has problems removing medium and coarse sand in maintaining open channels in rivers with rapid currents. It is difficult to hold the dredge in position when working upstream against the river currents since the working spud often slips due to scouring effects. When the dredge works downstream, the material that is loosened by the cutterhead is not pulled into the suction intake of the cutterhead. This causes a sandroll, or berm, of sandy material to form ahead of the dredge.

(4) The pipeline from the cutterhead dredge can cause navigation problems in small, busy waterways and harbors.

3-5. Dustpan Dredge.

a. General. The dustpan dredge is a hydraulic suction dredge that uses a widely flared dredging head along which are mounted pressure water jets (fig. 3-7). The jets loosen and agitate the sediments which are then captured in the dustpan head as the dredge itself is winched forward into the excavation. This type of dredge was developed by the Corps of Engineers to maintain navigation channels in uncontrolled rivers with bedloads consisting primarily of sand and gravel. The first dustpan dredge was developed to maintain navigation on the Mississippi River during low river stages. A dredge was needed that could operate in shallow water and be large enough to excavate the navigation channel in a reasonably short time. The dustpan dredge operates with a low-head, high-capacity centrifugal pump since the material has to be raised only a few feet above the water surface and pumped a short distance. The dredged material is normally discharged into open water adjacent to the navigation channel through a pipeline usually only 800 to 1000 ft long.

b. Description of Operation. The dustpan dredge maintains navigation channels by making a series of parallel cuts through the shoal areas until the authorized widths and depths are achieved. Typical operation procedures for the dustpan dredge are as follows:

(1) The dredge moves to a point about 500 ft upstream of the upper limit of the dredging area and the hauling anchors are set. Two anchors are used, as shown in Figure 3-8. The hauling winch cables attached to the anchors are crossed to provide better maneuverability and control of the vessel while operating in the channel prism.

(2) The dredge is then moved downstream to the desired location. The suction head is lowered to the required depth, dredge pump and water jet pumps are turned on, and the dredging commences. The dredge is moved forward by the hauling cables. The rate of movement depends on the materials being dredged, depth of dredging, currents, and wind. In shallow cuts, the advance may be as rapid as 800 ft/hr.

(3) When the upstream end of the cut is reached, the suction head is raised and the dredge is moved back downstream to make a parallel cut. This operation is repeated until the desired dredging widths and depths are achieved.

(4) The suction head may have to be lowered or raised if obstacles such as boulders, logs, or tree stumps are encountered. Experience with dustpan dredges indicates that the best results are obtained when the height of the cut face does not exceed 6 ft in depth.

(5) The dredge is moved outside the channel to let waterborne traffic pass through the area simply by raising the suction head and slacking off on one of the hauling winch cables. The propelling engines can be used to assist in maneuvering the dredge clear of the channel. The vessel is held in position by lowering the suction head or by lowering a spud.

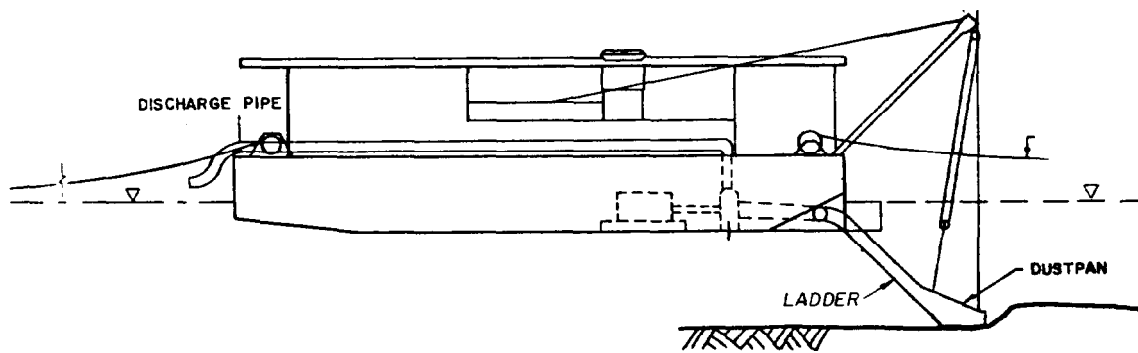
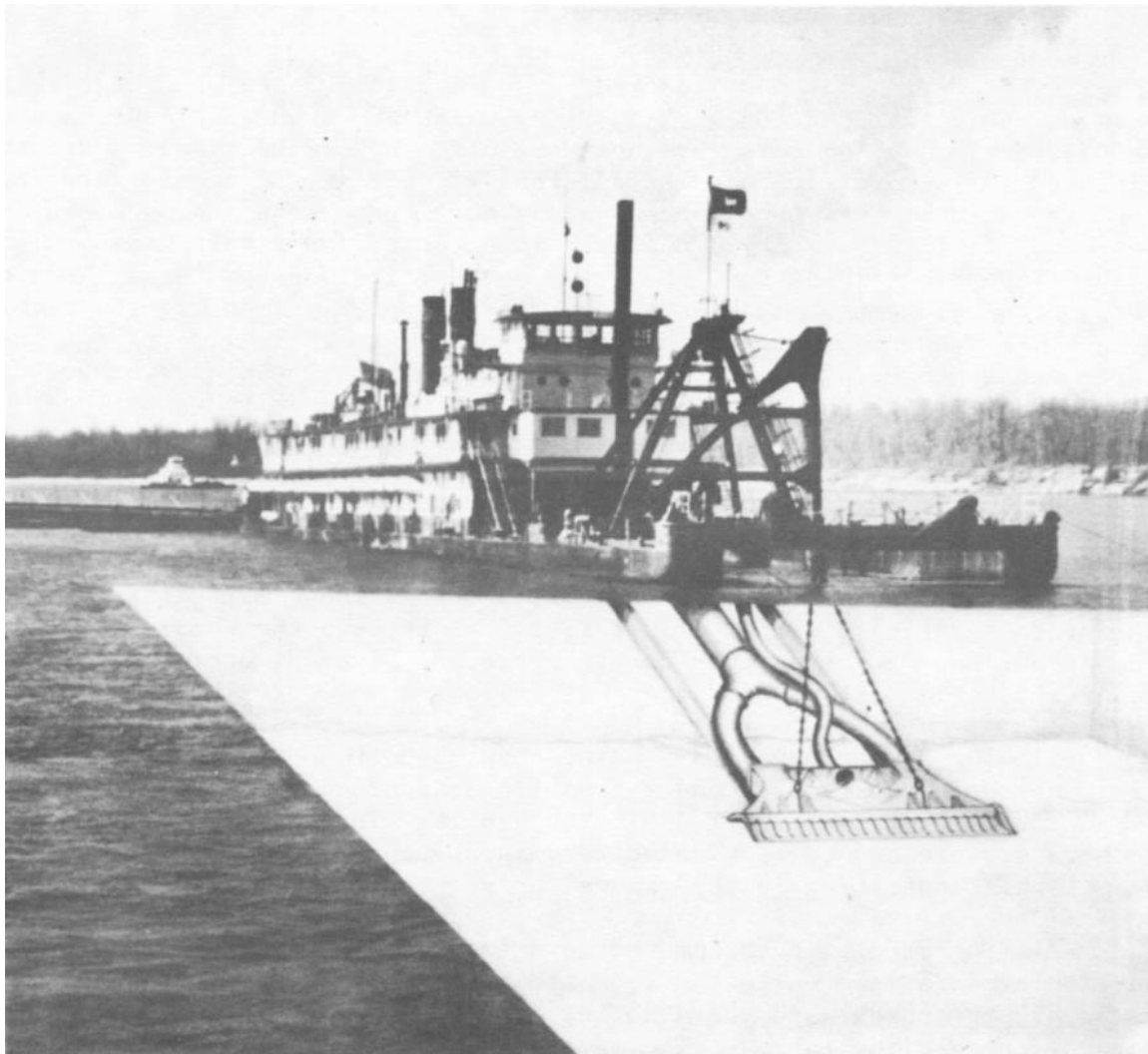

Figure 3-7. Dustpan dredge.

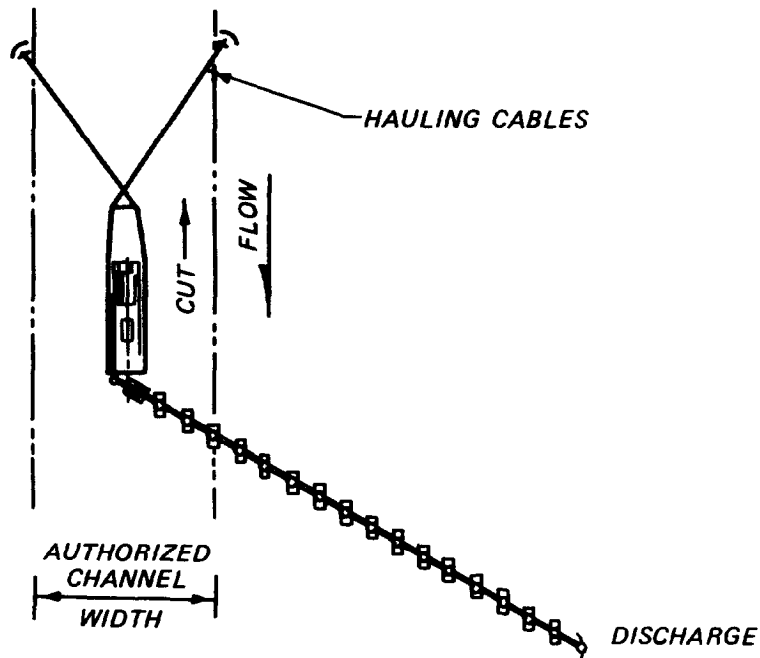

Figure 3-8. Operation of dustpan dredge (viewed from above).

c. Application. The pipeline system and the rigid ladder used with the dustpan dredge make it effective only in rivers or sheltered waters; it cannot be used in estuaries or bays where significant wave action occurs. Because it has no cutterhead to loosen hard, compact materials, the dustpan dredge is mostly suited for high-volume, loose-material dredging. Dustpan dredges are used to maintain the navigation channel of the uncontrolled open reaches of the Mississippi, Missouri, and Ohio Rivers. Dustpan dredging is principally a low-stage season operation. River channels are surveyed before the end of the high-stage season to determine the location and depths at the river crossings and sandbar formations, and dustpan dredging operations are planned accordingly. The existing fleet of Corps dustpan dredges is described briefly in table 3-4.

Table 3-4. Corps Dustpan Dredges.

<u>Name</u>	<u>District Location</u>	<u>Discharge Diameter, in.</u>	<u>Age, years</u>
Mitchell	Kansas City	34	47
Burgess	Memphis	32	47
Ockerson	Memphis	32	49
Potter	St. Louis	32	49
Jadwin	Vicksburg	32	47

These dredges are high-volume dredges capable of excavating a navigation channel through river sediment in a short time. During FY 71, the dredge Jadwin excavated over 6,200,000 cu yd, with an average production rate of approximately 3600 cu yd/hr. Detailed operations data for all the dustpan

dredges are reported on ENG Form 4267, "Report of Operations--Pipeline, Dipper, or Bucket Dredges." Refer to table 3-3 for specifications for a typical dustpan dredge.

d. Advantages. The dustpan dredge is self-propelled, which enables it to move rapidly over long distances to work at locations where emergencies occur. The attendant plant and pipeline are designed for quick assembly so that work can be started a few hours after arrival at the work site. The dustpan dredge can move rapidly out of the channel to allow traffic to pass and can resume work immediately. The high production rate and design of the dustpan dredge make it possible to rapidly remove sandbar formations and deposits from river crossings so that navigation channels can be maintained with a minimum of interruption to waterborne traffic.

e. Limitations. The dustpan dredge was designed for a specific purpose, and for this reason there are certain limitations to its use in other dredging environments. It can dredge only loose materials such as sands and gravels and only in rivers or sheltered waters where little wave action may be expected. The dustpan dredge is not particularly well suited for transporting dredged material long distances to upland disposal sites; pumping distances are limited to about 1000 ft without the use of booster pumps.

3-6. Sidecasting Dredges.

a. General. The sidecasting type of dredge (fig. 3-9) is a shallow-draft seagoing vessel, especially designed to remove material from the bar channels of small coastal inlets. The hull design is similar to that of a hopper dredge; however, sidecasting dredges do not usually have hopper bins. Instead of collecting the material in hoppers onboard the vessel, the sidecasting dredge pumps the dredged material directly overboard through an elevated discharge boom; thus, its shallow draft is unchanged as it constructs or maintains a channel. The discharge pipeline is suspended over the side of the hull by structural means and may be supported by either a crane or a truss-and-counterweight design. The dredging operations are controlled by steering the vessel on predetermined ranges through the project alignment. The vessel is self-sustaining and can perform work in remote locations with a minimum of delay and service requirements. The projects to which the sidecasters are assigned for the most part are at unstabilized, small inlets which serve the fishing and small-boat industries. Dangerous and unpredictable conditions prevail in these shallow inlets making it difficult for conventional plant to operate except under rare ideal circumstances.

b. Description of Operation. The sidecasting dredge picks up the bottom material through two dragarms and pumps it through a discharge pipe supported by a discharge boom. During the dredging process, the vessel travels along the entire length of the shoaled area casting material away from and beyond the channel prism. Dredged material may be carried away from the channel section by littoral and tidal currents. The construction of a deepened section through the inlet usually results in some natural scouring and deepening of the channel section, since currents moving through the prism tend to concentrate the scouring action in a smaller active zone. A typical sequence of events in a sidecasting operation is as follows:

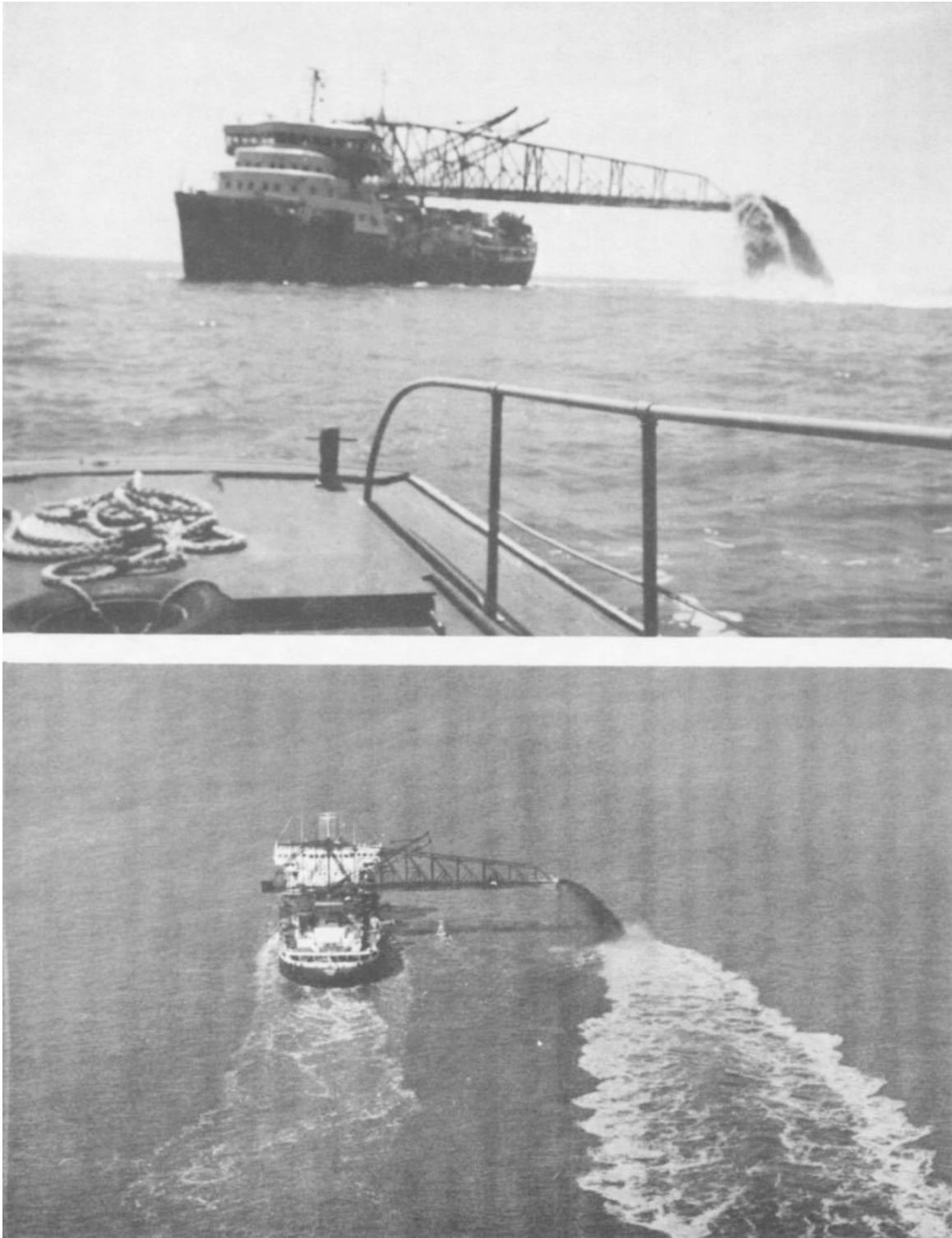

Figure 3-9. Sidcasting dredge.

- (1) The dredge moves to the work site.
- (2) The dragarms are lowered to the desired depth.
- (3) The pumps are started to take the material from the channel bottom and pump it through the discharge boom as the dredge moves along a designated line in the channel prism.
- (4) If adequate depths are not available across the bar during low tide levels, dredging must be started during higher tide levels. Under these conditions, the cuts are confined to a narrow channel width to quickly attain the flotation depth necessary for dredging to be continued during the low tidal periods.
- (5) The dredge continues to move back and forth across the bar until the channel dimensions are restored.
- (6) The discharge can be placed on either side of the dredge by rotating the discharge boom from one side of the hull to the other.

c. Application. The Corps of Engineers developed the shallow-draft sidecasting dredge for use in places too shallow for hopper dredges and too rough for pipeline dredges. The types of materials that can be excavated with the sidecasting dredge are the same as for the hopper dredges (para 3-3c).

d. Advantages. The sidecasting type of dredge, being self-propelled, can rapidly move from one project location to another on short notice and can immediately go to work once at the site. Therefore, a sidecasting dredge can maintain a number of projects located great distances from each other along the coastline.

e. Limitations. The sidecasting dredge needs flotation depths before it can begin to work because it dredges while moving over the shoaled area. Occasionally, a sidecaster will need to alter its schedule to work during higher tide levels periods only, due to insufficient depths in the shoaled area. Most areas on the seacoast experience a tidal fluctuation sufficient to allow even the shallowest shoaled inlets to be reconstructed by a sidecasting type of dredge. A shallow-draft sidecasting dredge cannot move large volumes of material compared to a hopper dredge, and some of the material removed can return to the channel prism due to the effects of tidal and littoral currents. The sidecasting dredge has only open-water disposal capability; therefore, it cannot be used for dredging contaminated sediments.

3-7. Dipper Dredges.

a. General. The dipper dredge is basically a barge-mounted power shovel. It is equipped with a power-driven ladder structure and operated from a barge-type hull. A schematic drawing and photograph of the dipper dredge are shown in figure 3-10. A bucket is firmly attached to the ladder structure and is forcibly thrust into the material to be removed. To

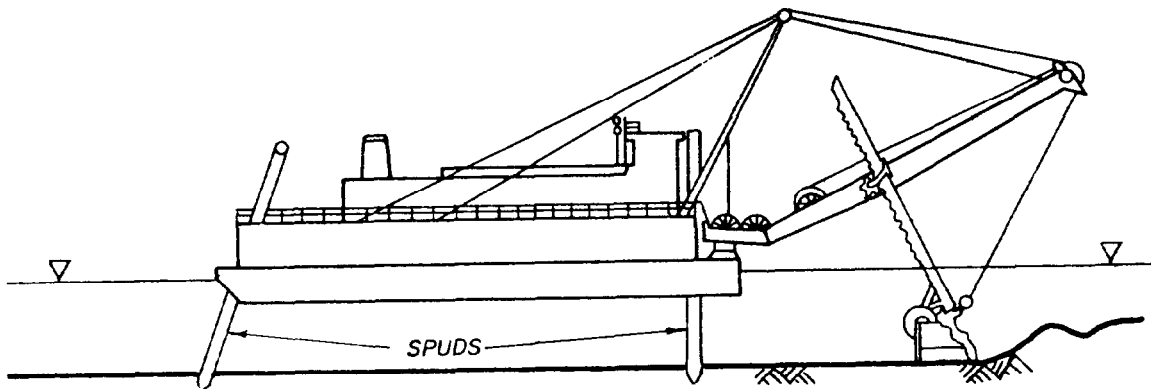

Figure 3-10. Dipper dredge.

increase digging power, the dredge barge is moored on powered spuds that transfer the weight of the forward section of the dredge to the bottom. Dipper dredges normally have a bucket capacity of 8 to 12 cu yd and a working depth of up to 50 ft. There is a great variability in production rates, but 30 to 60 cycles per hour is routinely achieved.

b. Description of Operation. The dipper type of dredge is not self-propelled but can move itself during the dredging process by manipulation of the spuds and the dipper arm. A typical sequence of operation is as follows :

(1) The dipper dredge, scow barges, and attendant plant are moved to the work site.

(2) The dredge is moved to the point where work is to start; part of the weight is placed on the forward spuds to provide stability.

(3) A scow barge is brought alongside and moored into place by winches and cables on the dipper dredge.

(4) The dredge begins digging and placing the material into the moored barge.

(5) When all the material within reach of the bucket is removed, the dredge is moved forward by lifting the forward spuds and maneuvering with the bucket and stern spud.

(6) The loaded barges are towed to the disposal area and emptied by bottom dumping if an open-water disposal area is used, or they are unloaded by mechanical or hydraulic equipment if diked disposal is required.

(7) These procedures are repeated until the dredging operation is completed.

c. Application. The best use of the dipper dredge is for excavating hard, compacted materials, rock, or other solid materials after blasting. Although it can be used to remove most bottom sediments, the violent action of this type of equipment may cause considerable sediment disturbance and resuspension during maintenance digging of fine-grained material. In addition, a significant loss of the fine-grained material will occur from the bucket during the hoisting process. The dipper dredge is most effective around bridges, docks, wharves, pipelines, piers, or breakwater structures because it does not require much area to maneuver; there is little danger of damaging the structures since the dredging process can be controlled accurately. No provision is made for dredged material containment or transport, so the dipper dredge must work alongside the disposal area or be accompanied by disposal barges during the dredging operation.

d. Advantages. The dipper dredge is a rugged machine that can remove bottom materials consisting of clay, hardpacked sand, glacial till, stone, or blasted rock material. The power that can be applied directly to the cutting edge of the bucket makes this type of dredge ideal for the removal

25 Mar 83

of hard and compact materials. It can also be used for removing old piers, breakwaters, foundations, pilings, roots, stumps, and other obstructions. The dredge requires less room to maneuver in the work area than most other types of dredges; the excavation is precisely controlled so that there is little danger of removing material from the foundation of docks and piers when dredging is required near these structures. Dipper dredges are frequently used when disposal areas are beyond the pumping distance of pipeline dredges, due to the fact that scow barges can transport material over long distances to the disposal area sites. The dipper type of dredge can be used effectively in refloating a grounded vessel. Because it can operate with little area for maneuvering, it can dig a shoal out from under and around a grounded vessel. The dipper dredge type of operation limits the volume of excess water in the barges as they are loaded. Dipper-dredged material can be placed in the shallow waters of eroding beaches to assist in beach nourishment.

e. Limitations. It is difficult to retain soft, semisuspended fine-grained materials in the buckets of dipper dredges. Scow-type barges are required to move the material to a disposal area, and the production is relatively low when compared to the production of cutterhead and dustpan dredges. The dipper dredge is not recommended for use in dredging contaminated sediments.

3-8. Bucket Dredges.

a. General. The bucket type of dredge is so named because it utilizes a bucket to excavate the material to be dredged (fig. 3-11). Different types of buckets can fulfill various types of dredging requirements. The buckets used include the clamshell, orangepeel, and dragline types and can be quickly changed to suit the operational requirements. The vessel can be positioned and moved within a limited area using only anchors; however, in most cases anchors and spuds are used to position and move bucket dredges. The material excavated is placed in scows or hopper barges that are towed to the disposal areas. Bucket dredges range in capacity from 1 to 12 cu yd. The crane is mounted on a flat-bottomed barge, on fixed-shore installations, or on a crawler mount. Twenty to thirty cycles per hour is typical, but large variations exist in production rates because of the variability in depths and materials being excavated. The effective working depth is limited to about 100 ft.

b. Description of Operation. The bucket type of dredge is not self-propelled but can move itself over a limited area during the dredging process by the manipulation of spuds and anchors. A typical sequence of operation is as follows:

(1) The bucket dredge, scows or hopper barges, and attendant plant are moved to the work site by a tug.

(2) The dredge is positioned at the location where work is to start and the anchors and spuds lowered into place.

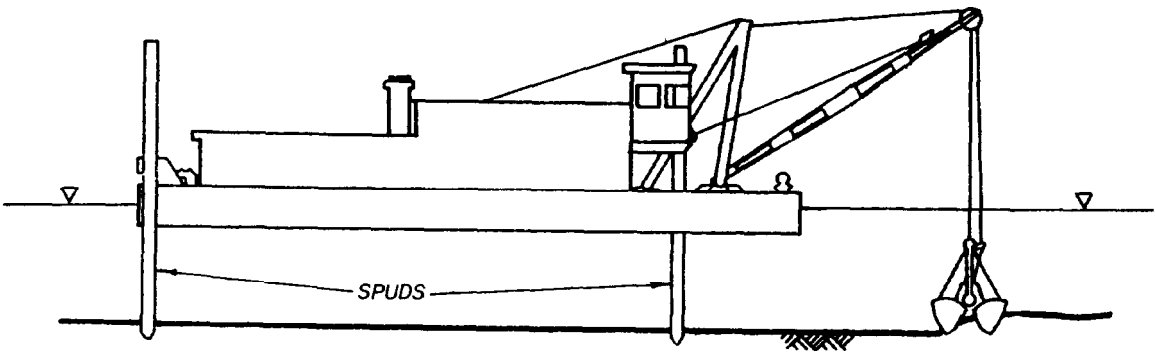

Figure 3-11. Bucket dredge.

(3) A scow or hopper barge is brought alongside and secured to the bucket dredge hull.

(4) The dredge begins the digging operation by dropping the bucket in an open position from a point above the sediment. The bucket falls through the water and penetrates into the bottom material. The sides or jaws of the bucket are then closed through the use of wire cables operated from the crane. As the sides of the bucket close, material is sheared from the bottom and contained in the bucket compartment. The bucket is raised above the water surface and swung to a point over the hopper barge. The material is then released into the hopper barge by opening the sides of the bucket.

(5) As material is removed from the bottom of the waterway to the desired depth at a given location, the dredge is moved to the next nearby location by using anchors. If the next dredging area is a significant distance away, the bucket dredge must be moved by a tug.

(6) The loaded barges are towed to the disposal area by a tug and emptied by bottom dumping if an open water disposal area is used. If a diked disposal area is used, the material must be unloaded using mechanical or hydraulic equipment.

(7) These procedures are repeated until the dredging operation is completed.

c. Application. Bucket dredges may be used to excavate most types of materials except for the most cohesive consolidated sediments and solid rock. Bucket dredges usually excavate a heaped bucket of material, but during hoisting turbulence washes away part of the load. Once the bucket clears the water surface, additional losses may occur through rapid drainage of entrapped water and slumping of the material heaped above the rim. Loss of material is also influenced by the fit and condition of the bucket, the hoisting speed, and the properties of the sediment. Even under ideal conditions, substantial losses of loose and fine sediments will usually occur. Because of this, special buckets must be used if the bucket dredge is to be considered for use in dredging contaminated sediments. To minimize the turbidity generated by a clamshell operation, watertight buckets have been developed (fig. 3-12). The edges seal when the bucket is closed and the top is covered to minimize loss of dredged material. Available sizes range from 2.6 to 26 cu yd. These buckets are best adapted for maintenance dredging of fine-grained material. A direct comparison of 1.3 cu-yd typical clamshell and watertight clamshell operations indicates that watertight buckets generate 30 to 70 percent less turbidity in the water column than typical buckets. This reduction is probably due primarily to the fact that leakage of dredged material from watertight buckets is reduced by approximately 35 percent. The bucket dredge is effective while working near bridges, docks, wharves, pipelines, piers, or breakwater structures because it does not require much area to maneuver; there is little danger of damaging the structures because the dredging process can be controlled accurately.

25 Mar 83

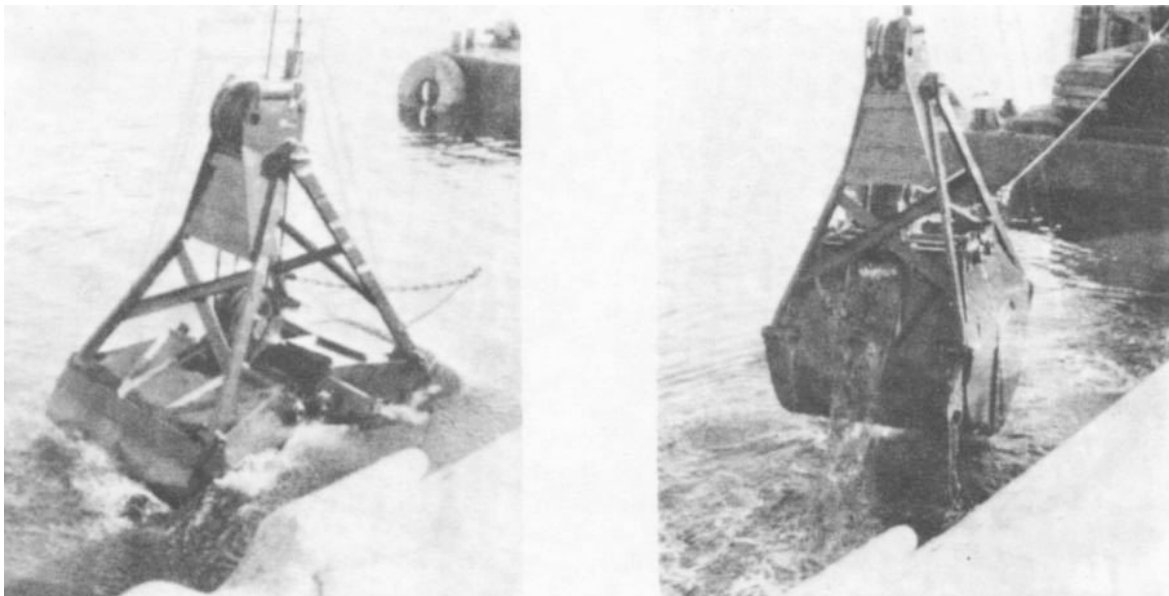

Figure 3-12. Open and closed positions of the watertight bucket.

d. Advantages. The bucket dredge has the same advantages cited for the dipper dredge, except that its capabilities in blasted rock and compact materials are somewhat less. The density of material excavated is about the same as the in-place density of the bottom material. Therefore, the volume of excess water is minimal, which increases the efficiency of operation in the transportation of material from the dredging area to the disposal area.

e. Limitations. The limitations of the bucket type of dredge are the same as those described for the dipper dredge (para 3-7e).

3-9. Special-Purpose Dredge

a. General. The Corps of Engineers Dredge CURRITUCK (fig. 3-13), assigned to the Wilmington District, is an example of a special-purpose type of dredge. Designed to work the same projects as sidecasting dredges, the CURRITUCK has the additional ability to completely remove material from the inlet complex and transport it to downdrift eroded beaches. It is a self-propelled split hull type of vessel, equipped with a self-leveling deck-house located at the stern, where all controls and machinery are housed. The vessel is hinged above the main deck so that the hull can open from bow to stern by means of hydraulic cylinders located in compartments forward and aft of the hopper section. The CURRITUCK has one hopper with a capacity of 315 cu yd. The hopper section is clearly visible to the operators in the pilot house, making production monitoring an easy task.

b. Description of Operation. The CURRITUCK operates in much the same way as a hopper dredge. The operator steers the vessel through the shoal

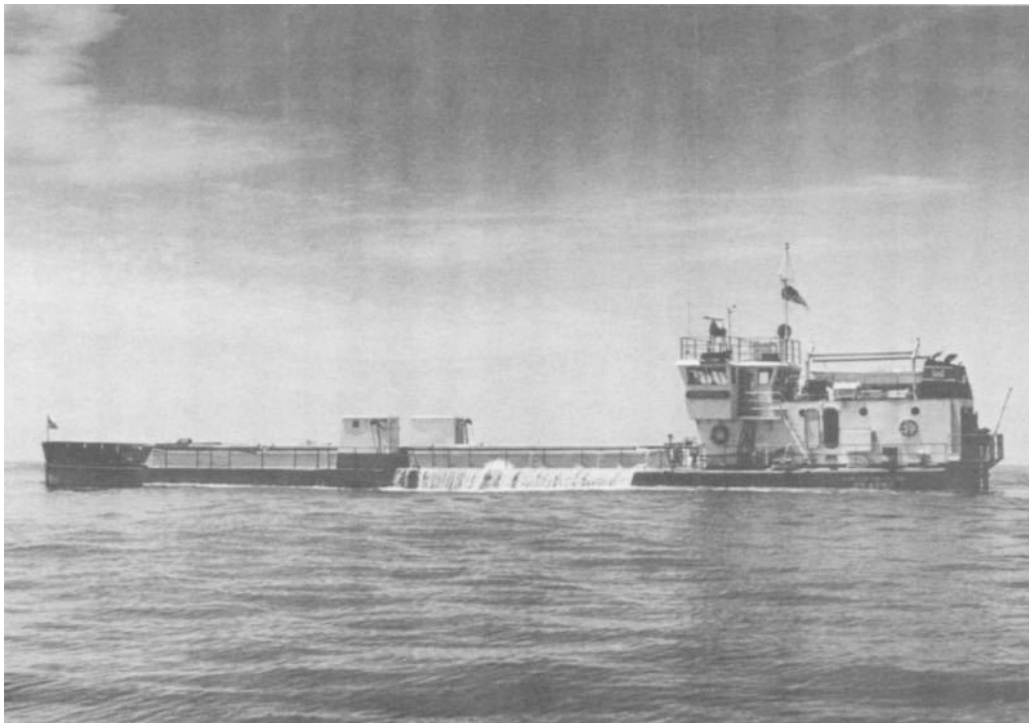

Figure 3-13. Corps special-purpose dredge.

areas of the channel. The dredge pumps, located in the compartments on each side of the hull, pump material through trailing dragarms into the hopper section. When an economic load is obtained, the dragarms are lifted from the bottom of the waterway and the dredge proceeds to the disposal area. A major difference between the operation of the CURRITUCK and that of a conventional hopper dredge is in the method of disposal; the CURRITUCK is designed to transport and deposit the dredged material close to the surf zone area.

c. Application. The CURRITUCK provides a sand-bypassing capability in addition to improving the condition of navigation channels. The CURRITUCK excavates material from navigation channels, transports it to downdrift eroded beaches, and releases it where it is needed to provide beach nourishment, rather than wasting it offshore. After the material has been deposited in the near-shore coastal areas, the dredge backs away and returns to the navigation channel.

d. Advantages. The CURRITUCK is an effective dredging tool for use in shallow-draft inlets. All of the dredged material is placed in the littoral zone. The CURRITUCK can also be used to supplement sidecasting dredges and to transport dredged materials from inlet channels to the near-shore areas of eroded beaches.

e. Limitations. The production rate of the CURRITUCK is limited by its small hopper capacity. Therefore, it is not effective on major navigation channels. In addition, when the flotation depths are minimal it is necessary to use a sidecasting dredge to provide access into the project.

3-10. Summary of Dredge Operating Characteristics. The important operating characteristics of each dredge presented in the preceding sections are summarized in table 3-5. In some cases, a wide range of values is given to account for the various sizes of plants within each class. In other instances, the information provides a qualitative judgement (high, low, average) of each dredge type's performance in a given area. Table 3-5 should be helpful in making quick assessments of the suitability of a given dredge type in a known physical setting.

3-11. Locations of Dredges in the United States. Figure 3-14 shows the distribution of dredging capability for the Corps and industry in the United States by region. Congress has determined (Public Law 95-269) that the Corps will operate a dredging fleet adequate to meet emergency and national defense requirements at home and abroad. This fleet will be maintained to technologically modern and efficient standards and will be kept in a fully operational status. The status of the United States dredging fleet as determined in the Corps of Engineers' National Dredging Study is comprehensively summarized in a paper of the same title (item 6). A detailed inventory of all dredges in the United States is published annually in World Dredging and Marine Construction (item 10). The designer can consult this source for information on the specific types of dredges available in the proposed project area.

Table 3-5. Summary of Dredge Operating Characteristics.^a

Dredge Type	Percent Solids		Turbidity Caused	Open-Water Operation	Vessel Draft ft	Approx. Range of Production Rates cu yd/hr	Dredging Depths ft		Limiting Wave Height ft	Limiting Current	Lateral Dredging Accuracy ft
	in situ	by weight ^b					Minimum	Maximum			
Dipper	in situ	in situ	high	yes ^d	e	30-500	0 ^f	50	<3 ^g	h	1/2
Bucket	in situ	in situ	high ⁱ	yes ^d	e	30-500	0 ^f	100 ^j	<3 ^{g,k}	h	1
Dustpan	10-20%	10-20%	avg.	no	5-14	1200-5,700	5-14	50-60 ^l	<3	h	2-3
Cutterhead	10-20%	10-20%	avg.	yes ^d	3-14	25-10,000	3-14	12-65 ^l	<3	h	2-3
Hopper	10-20%	10-20%	avg.	yes	12-31	500-2,000	10-28	80	<7	h	10
Sidecasting	10-20%	10-20%	high	yes	5-9	325-650	6	25	<7	h	10
Special-Purpose	10-20%	10-20%	avg.	yes	5-8	250 avg.	8	20	<7	h	10

^aPrepared by WES.

^bPercent solids could theoretically be 0, but these are normal working ranges. Percent solids = $\frac{\text{wt. of dry sediment}}{\text{wt. of wet slurry}}$.

^cVertical accuracies are generally within ±1 ft.

^dLimited operation in open water possible, depending on hull size and type and wave height.

^eDepends on floating structure; if barge-mounted, approximately 5- to 6-ft draft.

^fZero if used alongside of waterway; otherwise, draft of vessel will determine.

^gDepends on supporting vessel--usually barge-mounted.

^hLiterature implies that water current hinders dredging operations, but references avoid establishing maximum current limitations. For most dredges, limiting current is probably in the 3- to 5-knot range, with hopper and dustpan dredges able to work at currents of perhaps 7 knots.

ⁱLow, if watertight bucket is used.

^jDemonstrated depth; theoretically could be used much deeper.

^kTheoretically unaffected by wave height; digging equipment not rigid.

^lWith submerged dredge pumps, dredging depths have been increased to 100 ft or more.

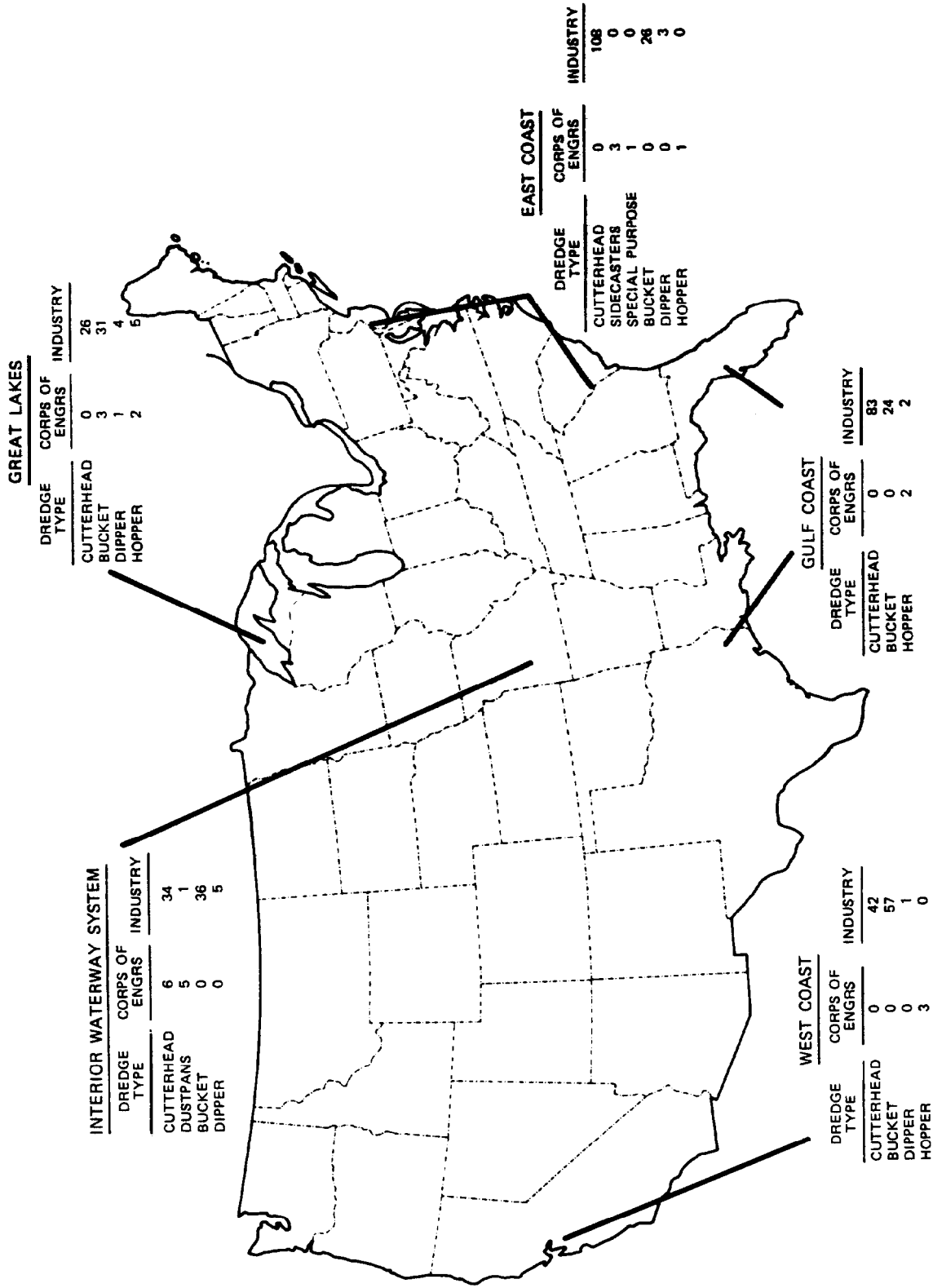

Figure 3-14. Distribution of dredging capability for the Corps and industry.
(data obtained from item 10)

3-12. Agitation Dredging Techniques.

a. General. Agitation dredging is the process of removing bottom material from a selected area by using equipment to raise it in the water column and allowing currents to carry it from the project area. In the most detailed study available on agitation dredging techniques, Richardson (item 7) evaluated past agitation dredging projects and presented guidelines and recommendations for using agitation dredging. Two distinct phases are involved in agitation dredging: (1) suspension of bottom sediments by some type of equipment, and (2) transport of the suspended material by currents. The main purpose of the equipment is to raise bottom material in the water column. Natural currents are usually involved in transporting the material from the dredging site, although the natural currents may be augmented with currents generated by the agitation equipment. Agitation dredging is accomplished by methods such as hopper dredge agitation, prop-wash, vertical mixers or air bubble, rakes or drag beams, and water jets. Based on the work done by Richardson (item 7), only hopper dredge, prop-wash, and rake or beam dragging agitation justify more detailed discussion in this EM.

b. Objectives. The main objective of agitation dredging is the removal of bottom material from a selected area. If the material is suspended but redeposits shortly in the same area, only agitation (not agitation dredging) has been accomplished. The decision to use agitation dredging should be based primarily on the following factors:

(1) Technical feasibility. The equipment to generate the required level of agitation must be available, and the agitated material must be carried away from the project area by currents.

(2) Economic feasibility. Agitation dredging must be determined the most cost-effective method for achieving the desired results; it should not affect the costs of other dredging projects downstream by increasing dredging volumes.

(3) Environmental feasibility. Agitation dredging should not cause unacceptable environmental impacts.

c. Hopper Dredge Agitation.

(1) General. Refer to para 3-3a for a general description of hopper dredges. In agitation dredging, hopper capacity is of secondary importance compared with pumping rates, mobility, and overflow provisions.

(2) Description of operation. The general operation of a hopper dredge is discussed in para 3-3b. In hopper dredge agitation, the conventional dredge-haul-dump operating mode is modified by increasing the dredging mode and reducing the haul-dump mode. It has been reported that hopper dredge agitation can allow a project to be maintained with a dredge which is relatively small compared with the size dredge required for a conventional dredge-haul-dump operation. Hopper dredge agitation is of

two types: (a) intentional agitation produced by hopper overflow; and (b) auxiliary agitation caused by dragheads and propeller wash. Since the latter is present in all hopper dredge operations and since it is difficult to quantify separately from hopper overflow, both types are measured together when reporting hopper dredge agitation effectiveness.

(3) Application. Agitation hopper dredging can perform the same maintenance functions as conventional hopper dredging if the following conditions are satisfied: (a) sediments are fine-grained and loosely consolidated, (b) currents are adequate to remove the agitated sediments from the project area, and (c) no unacceptable environmental impact results from the agitation dredging.

(4) Advantages. Because currents, not equipment, transport most of the sediment from the project area during agitation hopper dredging, the following advantages are realized: (a) hopper dredge agitation costs can be several times less per cubic yard than hopper dredge hauling costs and (b) smaller hopper dredges can be used to maintain certain projects.

(5) Limitations. Hopper dredge agitation should be applied only to specific dredging sites and not used as a general method to maintain large areas. The following limitations must be noted when considering this dredging technique for use at a site: (a) hopper dredge agitation cannot be used in environmentally sensitive areas where unacceptable environmental impacts may occur and (b) sediments and current conditions must be suitable for agitation dredging.

d. Prop-Wash Agitation.

(1) General. Prop-wash agitation dredging is performed by vessels especially designed or modified to direct propeller-generated currents into the bottom shoal material. The agitated material is suspended in the water column and carried away by a combination of natural currents and prop-wash currents. Unintentional prop-wash agitation dredging often occurs while vessels move through waterways. This type of sediment resuspension is uncontrolled and is often considered undesirable.

(2) Description of operation. The prop-wash vessel performs best when work begins at the upstream side of a shoal and proceeds downstream with the prop-wash-generated current directed downstream. The vessel is anchored in position, and prop-wash-generated currents are directed into the shoal material for several minutes. The vessel is then repositioned and the process is repeated.

(3) Application. Prop-wash agitation dredging has been successfully used in coastal harbors, river mouths, river channels, and estuaries. It is a method intended for use in loose sands and in maintenance dredged material consisting of uncompacted clay and silt. Cementing, cohesion, or compaction of the bottom sediment can make prop-wash agitation dredging difficult to perform. Waves may cause anchoring problems with the agitation vessel. Optimum water depths for prop-wash agitation dredging in sand

are between two and three times the agitation vessel's draft. Based on studies by Richardson (item 7), the average performance of vessels specially designed for prop-wash agitation range from 200 to 300 cu yd/hr in sand and are a little higher for fine-grained material.

(4) Advantages. The major advantages of prop-wash agitation dredging are related to economics. In some areas, prop-wash agitation dredging has been found to cost 40 to 90 percent less per cubic yard dredged than conventional dredging methods.

(5) Limitations. The limitations on prop-wash agitation dredging are as follows: (a) prop-wash agitation seems best suited for areas with little or no wave action, (b) prop-wash agitation should be applied in water depths less than four times the agitation vessel's draft, and (c) the sediments must be loose sands, silt, or clay.

e. Rakes and Drag Beams. Rakes, drag beams, and similar devices work by being pulled over the bottom (usually by a vessel), mechanically loosening the bottom material, and raising it into the water column to be carried away by natural currents. Since rakes and drag beams do not produce currents of their own and since they do not resuspend material as much as loosen it, these devices must be used in conjunction with currents strong enough to transport the loosened material away from the shoaling site; in addition, the vessel towing one of these devices may provide some resuspension and transport by its propwash. A wide range of dredging rates have been reported for agitation dredging by rakes and beams. Little value would be obtained by reporting these rates because they are highly dependent upon site conditions; however, it has been reported that the cost of agitation dredging by rakes and beams can be less than 10 percent of the cost for conventional dredging. Data show a definite correlation between dragging speed and dredging rate. The advantages and limitations for rake and drag beams are similar to those reported for other agitation dredging techniques.

f. Environmental Considerations. The environmental considerations discussed in Chapter 4 also apply to all agitation dredging techniques. The properties of sediments affect the fate of contaminants, and the short- and long-term physical and chemical conditions of the sediments at the agitation dredging site influence the environmental consequences of contaminants. These factors should be considered in evaluating the environmental risk of a proposed agitation dredging technique.

3-13. Advances in Dredging Technology. Advanced dredging technologies are generally directed toward one or more of the following areas of improvement: greater depth capability; greater precision, accuracy, and control over the dredging process; higher production efficiency; and decreased environmental harm. Following are brief descriptions of the major recent innovations in production dredging:

- a. Ladder-mounted submerged pumps for higher production.

- b. Improved designs of dredging heads to minimize material resuspension.
- c. Use of spud barges aft of the dredge to extend hull length and increase dredge swing. This will increase production efficiency of cutter-head dredges.
- d. Longer ladders, connected further aft on the dredge hull to increase depth and permit greater control.
- e. Tandem pump systems for greater production efficiency and reliability.
- f. Better hull designs equipped with liquid stabilizing systems (motion compensators) to allow use in heavier seas.
- g. Improved production instrumentation to monitor flow rates, densities, cumulative production, etc.
- h. Improved navigation, positioning, and bottom profiling instrumentation. The state of the art includes advanced laser, electronic, and acoustical systems.
- i. Closed-bucket modifications to reduce loss of fines and liquid from bucket dredges.
- j. Depth and swing indicators for mechanical dredges.
- k. Use of silt curtains during dredging and open-water disposal to restrict turbidity plumes and, in the case of contaminated materials, limit the added dispersion due to dredging.

3-14. Environmental Considerations. The adverse environmental effects normally associated with dredging operations are increases in turbidity, resuspension of contaminated sediments, and decreases in dissolved oxygen. Selection and operation of the type of dredge plant as well as the type of sediment being dredged affect the degree of adverse impacts during dredging. Investigations which have been conducted by WES under the DMRP have studied the environmental effects caused by dredging and disposal operations. The results of these studies have been published as WES Technical Reports. Guidance on the environmental aspects of dredging and disposal is presented in Chapter 4.

CHAPTER 4
DISPOSAL ALTERNATIVES

4-1. Introduction.

a. While selection of proper dredging equipment and techniques is essential for economic dredging, the selection of a disposal alternative is of equal or greater importance in determining viability of the project, especially from the environmental standpoint. There are three major disposal alternatives available:

- (1) Open-water disposal.
- (2) Confined disposal.
- (3) Habitat development.

Each of the major disposal alternatives involves its own set of unique considerations, and selection of a disposal alternative should be made based on both economic and environmental considerations.

b. This chapter describes considerations in evaluation of disposal alternatives, primarily from an environmental standpoint. Sections on evaluation of pollution potential and sediment resuspension due to dredging apply to all disposal alternatives, while separate sections describe considerations of each of the three major disposal alternatives.

Section I. Evaluation of Dredged Material Pollution Potential

4-2. Influence of Disposal Conditions on Environmental Impact.

a. As discussed in WES TR DS-78-6, the properties of a dredged sediment affect the fate of contaminants, and the short- and long-term physical and chemical environment of the dredged material at the disposal site influences the environmental consequences of contaminants. These factors should be considered in evaluating the environmental risk of a proposed disposal method for contaminated sediment. The processes involved with release or immobilization of most sediment-associated contaminants are regulated to a large extent by the physical-chemical environment and the related bacteriological activity associated with the dredged material at the disposal site. Important physical-chemical parameters include pH, oxidation-reduction conditions, and salinity. Where the physical-chemical environment of a contaminated sediment is altered by disposal, chemical and biological processes important in determining environmental consequences of potentially toxic materials may be affected.

b. The major sediment properties that will influence the reaction of dredged material with contaminants are the amount and type of clay; organic matter content; amount and type of cations and anions associated with the sediment; the amount of potentially reactive iron and manganese; and the oxidation-reduction, pH, and salinity conditions of the sediment. Although each of these sediment properties is important, much concerning the release

of contaminants from sediments can be inferred from the clay and organic matter content, initial and final pH, and oxidation-reduction conditions. Much of the dredged material removed during harbor and channel maintenance dredging is high in organic matter and clay and is both biologically and chemically active. It is usually devoid of oxygen and may contain appreciable sulfide. These sediment conditions favor effective retention of many contaminants, provided the dredged materials are not subject to mixing, resuspension, and transport. Sandy sediments low in organic matter content are much less effective in retaining metal and organic contaminants. These materials tend not to accumulate contaminants unless a contamination source is nearby. Should contamination of these sediments occur, potentially toxic substances may be readily released upon mixing in a water column, or by leaching and possibly plant uptake under intertidal or upland disposal conditions.

c. Many contaminated sediments are reducing and near neutral in pH, initially. Disposal into quiescent waters will generally maintain these conditions and favor contaminant retention. Certain sediments (noncalcareous and containing appreciable reactive iron and particularly reduced sulfur compounds) may become moderately to strongly acid upon gradual drainage and subsequent oxidation as may occur under upland disposal conditions. This altered disposal environment greatly increases the potential for releasing potentially toxic metals. In addition to the effects of pH changes, the release of most potentially toxic metals is influenced to some extent by oxidation-reduction conditions, and certain of the metals can be strongly affected by oxidation-reduction conditions. Thus, contaminated sandy, low organic-matter-content sediments pose the greatest potential for release of contaminants under all conditions of disposal. Sediments which tend to become strongly acid upon drainage and long-term oxidation also pose a high environmental risk under some disposal conditions. The implications of the influence of disposal conditions on contaminant mobility are discussed below.

4-3. Methods of Characterizing Pollution Potential.

a. Bioassay. Bioassay tests are used to determine the effects of a contaminant(s) on biological organisms of concern. They involve exposure of the test organisms to dredged material (or some fraction such as the elutriate) for a specified period of time, followed by determination of the response of the organisms. The most common response of interest is death. Often the tissues of organisms exposed to dredged material are analyzed chemically to determine whether they have incorporated, or bioaccumulated, any contaminants from the dredged material. Bioassays provide a direct indication of the overall biological effects of dredged material. They reflect the cumulative influence of all contaminants present, including any possible interactions of contaminants. Thus, they provide an integrated measurement of potential biological effects of a dredged material discharge. For precisely these reasons, however, a bioassay cannot be used to identify the causative agent(s) of impact in a dredged material. This is of interest, but is seldom of importance, since usually the dredged material cannot be treated to remove the adverse components even if they could be identified. Dredged material bioassay techniques for aquatic animals have been

implemented in the ocean-dumping regulatory program for several years (item 1) and are easily adapted for use in fresh water. Dredged material bioassays for wetland and terrestrial plants have also been developed (item 2) and are coming into ever-wider use.

b. Water Column Chemistry. Chemical constituents contained in or associated with sediments are unequally distributed among different chemical forms depending on the physical-chemical conditions in the sediments and the overlying water. When contaminants introduced into the water column become fixed into the underlying sediments, they rarely if ever become part of the geological mineral structure of the sediment. Instead, these contaminants remain dissolved in the sediment interstitial water, or pore water, become absorbed or adsorbed to the sediment ion exchange portion as ionized constituents, form organic complexes, and/or become involved in complex sediment oxidation-reduction reactions and precipitations. The fraction of a chemical constituent that is potentially available for release to the water column when sediments are disturbed is approximated by the interstitial water concentrations and the loosely bound (easily exchangeable) fraction in the sediment. The elutriate test is a simplified simulation of the dredging and disposal process wherein predetermined amounts of dredging site water and sediment are mixed together to approximate a dredged material slurry. The elutriate is analyzed for major dissolved chemical constituents deemed critical for the proposed dredging and disposal site after taking into account known sources of discharges in the area and known characteristics of the dredging and disposal site. Results of the analysis of the elutriate approximate the dissolved constituent concentration for a proposed dredged material disposal operation at the moment of discharge. These concentrations can be compared to water quality standards and mixing zone considerations to evaluate the potential environmental impact of the proposed discharge activity in the discharge area.

c. Total or Bulk Sediment Chemistry. The results of these analyses provide some indication of the general chemical similarity between the sediments to be dredged and the sediments at the proposed disposal site. The total composition of sediments, when compared with natural background levels at the site, will also, to some extent, reflect the inputs to the waterway from which they were taken and may sometimes be used to identify and locate point source discharges. Since chemical constituents are partitioned among various sediment fractions, each with its own mobility and biological availability, a total sediment analysis is not a useful index of the degree to which dredged material disposal will affect water quality or aquatic organisms. Total sediment analysis results are further limited because they cannot be compared to any established water quality criteria in order to assess the potential environmental impact of discharge operations. This is because the water quality criteria are based on water-soluble chemical species, while chemical constituents associated with dredged material suspensions are generally in particulate/solid-phase forms or mineralogical forms that have markedly lower toxicities, mobilities, and chemical reactivities than the solution-phase constituents. Consequently, little information about the biological effects of solid-phase and mineral constituents that make up the largest fraction of dredged material can be gained from total or bulk sediment analysis.

Section II. Sediment Resuspension Due to Dredging

4-4. Factors Influencing Dredging Turbidity.

a. Occurrence and Extent. The nature, degree, and extent of sediment suspension around a dredging or disposal operation are controlled by many factors, as discussed in WES TR DS-78-13. Chief among these are: the particle size distribution, solids concentration, and composition of the dredged material; the dredge type and size, discharge/cutter configuration, discharge rate, and solids concentration of the slurry; operational procedures used; and finally the characteristics of the hydraulic regime in the vicinity of the operation, including water composition, temperature and hydrodynamic forces (i.e., waves, currents, etc.) causing vertical and horizontal mixing. The relative importance of the different factors may vary significantly from site to site.

b. Hopper Dredge. Resuspension of fine-grained maintenance dredged material during hopper dredging operations is caused by the dragheads as they are pulled through the sediment, turbulence generated by the vessel and its prop wash, and overflow of turbid water during hopper filling operations. During the filling operation, dredged material slurry is often pumped into the hoppers after they have been filled with slurry in order to maximize the amount of solid material in the hopper. The lower density, turbid water at the surface of the filled hoppers overflows and is usually discharged through ports located near the waterline of the dredge. In the vicinity of hopper dredges during maintenance operations, a near-bottom turbidity plume of resuspended bottom material may extend 2300 to 2400 ft downcurrent from the dredge. In the immediate vicinity of the dredge, a well-defined, upper plume is generated by the overflow process. Approximately 1000 ft behind the dredge the two plumes merge into a single plume (fig. 4-1). Suspended solid concentrations above ambient may be as high as

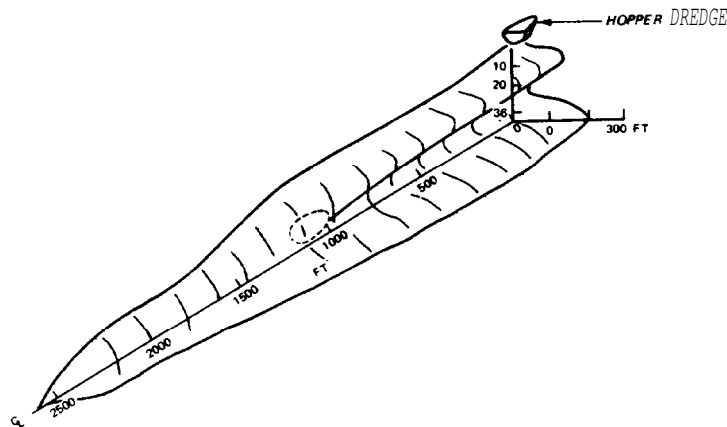

Figure 4-1. Hypothetical suspended solids plume downstream of a hopper dredge operation with overflow in San Francisco Bay (all distances in feet)*

several tens of parts per thousand (grams per litre) near the discharge port and as high as a few parts per thousand near the draghead. Turbidity levels in the near-surface plume appear to decrease exponentially with increasing distance from the dredge due to settling and dispersion, quickly reaching concentrations less than 1 ppt. However, plume concentrations may exceed background levels even at distances in excess of 4000 ft.

c. Bucket or Clamshell Dredge. The turbidity generated by a typical clamshell operation can be traced to sediment resuspension occurring when the bucket impacts on and is pulled off the bottom, turbid water spills out of the bucket or leaks through openings between the jaws, and material is inadvertently spilled during the barge loading operation. There is a great deal of variability in the amount of material resuspended by clamshell dredges due to variations in bucket size, operating conditions, sediment types, and hydrodynamic conditions at the dredging site. Based on limited measurements, it appears that, depending on current velocities, the turbidity plume downstream of a typical clamshell operation may extend approximately 1000 ft at the surface and 1600 ft near the bottom. Maximum concentrations of suspended solids in the surface plume should be less than 0.5 ppt in the immediate vicinity of the operation and decrease rapidly with distance from the operation due to settling and dilution of the material. Average water-column concentrations should generally be less than 0.1 ppt. The near-bottom plume will probably have a higher solids concentration, indicating that resuspension of bottom material near the clamshell impact point is probably the primary source of turbidity in the lower water column. The visible near-surface plume will probably dissipate rapidly within an hour or two after the operation ceases.

d. Cutterhead or Hydraulic Pipeline Dredge. Most of the turbidity generated by a cutterhead dredging operation is usually found in the vicinity of the cutter. The levels of turbidity are directly related to the type and quantity of material cut, but not picked up, by the suction. The ability of the dredge's suction to pick up bottom material determines the amount of cut material that remains on the bottom or suspended in the water column. In addition to the dredging equipment used and its mode of operation, turbidity may be caused by sloughing of material from the sides of vertical cuts; inefficient operational techniques; and the prop wash from the tenders (tugboats) used to move pipeline, anchors, etc., in the shallow water areas outside the channel. Based on limited field data collected under low current conditions, elevated levels of suspended material appear to be localized in the immediate vicinity of the cutter as the dredge swings back and forth across the dredging site. Within 10 ft of the cutter, suspended solids concentrations are highly variable but may be as high as a few tens of parts per thousand; these concentrations decrease exponentially from the cutter to the water surface. Near-bottom suspended solids concentrations may be elevated to levels of a few tenths of a part per thousand at distances of less than 1000 ft from the cutter.

Section III. Open-Water Disposal

4-5. Behavior of Discharges from Various Types of Dredges.

a. Hopper Dredge. The characteristics and operation of hopper dredges are discussed in para 3-3 of this manual. When the hoppers have been filled as described, the dragarms are raised and the hopper dredge proceeds to the disposal site. At the disposal site, hopper doors in the bottom of the ship's hull are opened and the entire hopper contents are emptied in a matter of seconds; the dredge then returns to the dredging site to reload. This procedure produces a series of discrete discharges at intervals of perhaps one to several hours. Upon release from the hopper dredge at the disposal site, the dredged material falls through the water column as a well-defined jet of high-density fluid which may contain blocks of solid material. Ambient water is entrained during descent. After it hits bottom, some of the dredged material comes to rest. Some material enters the horizontally spreading bottom surge formed by the impact and is carried away from the impact point until the turbulence of the surge is sufficiently reduced to permit its deposition.

b. Bucket or Clamshell Dredge. Bucket dredges remove the sediment being dredged at nearly its in situ density and place it in barges or scows for transportation to the disposal area, as described in para 3-8. Although several barges may be used so that the dredging is essentially continuous, disposal occurs as a series of discrete discharges. The dredged material may be a slurry similar to that in a hopper dredge, but often sediments dredged by clamshell remain in fairly large consolidated clumps and reach the bottom in this form. Whatever its form, the dredged material descends rapidly through the water column to the bottom, and only a small amount of the material remains suspended.

c. Cutterhead or Hydraulic Pipeline Dredge. The operation of a cutterhead dredge, described in para 3-4, produces a slurry of sediment and water discharged at the disposal site in a continuous stream. As the dredge progresses up the channel, the pipeline is moved periodically to keep abreast of the dredge. The discharged dredged material slurry is generally dispersed in three modes. Any coarse material, such as gravel, clay balls, or coarse sand, will immediately settle to the bottom of the disposal area and usually accumulates directly beneath the discharge point. The vast majority of the fine-grained material in the slurry also descends rapidly to the bottom in a well-defined jet of high-density fluid, where it forms a low-gradient circular or elliptical fluid mud mound. Approximately 1 to 3 percent of the discharged material is stripped away from the outside of the slurry jet as it descends through the water column and remains suspended as a turbidity plume.

4-6. Dredged Material Dispersion at the Discharge Site.

a. Water-Column Turbidity. The levels of suspended solids in the water column around a discharge operation generally range from a few hundredths to a few tenths of a part per thousand. Concentrations are highest near the discharge point and rapidly decrease with increasing distance

downstream from the discharge point and laterally away from the plume center line due to settling and horizontal dispersion of the suspended solids. Concentrations also decrease rapidly between each discrete hopper or barge discharge and after a pipeline is shut down or moved to a new location. Under tidal conditions, the plume will be subject to the tidal dynamics of the particular bay, estuary, or river mouth in which the dredging activity takes place. Many of the Corps projects have been studied in physical hydraulic models, and estimates of plume excursion can be made from their model reports. Rough estimates can be made from numerical models. Mathematical model result can be materially improved when calibrated by physical and/or prototype data; except under very simple conditions, all models have to be verified with prototype or prototype-derived data. In rivers where the flow is unidirectional, the plume length is controlled by the strength of the current and the settling properties of the suspended material. In both estuarine and riverine environments the natural levels of turbulence and the fluctuations in the rate of slurry discharge will usually cause the idealized teardrop-shaped plume to be distorted by gyres or eddylike patterns, as in figure 4-2.

b. Fluid Mud. A small percentage of the fine-grained dredged material slurry discharged during open-water disposal is dispersed in the water column as a turbidity plume; however, the vast majority rapidly descends to the bottom of the disposal area where it accumulates under the discharge point in the form of a low-gradient fluid mud mound overlying the existing bottom sediment, as shown in figure 4-3. If the discharge point of a hydraulic pipeline dredge is moved as the dredge advances, a series of mounds will develop. The majority of the mounded material is usually high-density (nonflowing) fluid mud that is covered by a surface layer of low-density (flowing or nonflowing) fluid mud. Under quiescent conditions, more than 98 percent of the sediment in the mudflow remains in the fluid mud layer at concentrations greater than 10 ppt, while the remaining 2 percent may be resuspended by mixing with the overlying water at the fluid mud surface. Fluid mud will tend to flow downhill as long as the bottom slope is approximately 1 percent or greater. A study of hopper dredge disposal at Carquinez Strait, San Francisco Bay, showed concentrations of dredged material in the water column were generally less than 0.2 ppt above background and persisted for only a few tens of minutes. However, 3 to 8 ft above the bottom, concentrations reached 20 ppt in a fluid mud layer. Similar occurrences of low suspended sediment concentrations in the water column with concentrations on the order of several tens of parts per thousand just above the bottom, as in figure 4-4, have been discussed for pipeline dredge discharges in WES TR DS-78-13. These conditions persist for the duration of the disposal operation at the site and for varying times thereafter as the material consolidates to typical sediment density.

c. Mounding. If bottom slopes are not great enough to maintain mudflows, the fluid mud will stop and begin to consolidate. When suspended sediment concentrations exceed 200 ppt the fluid mud can no longer flow freely but will accumulate around the discharge point in a low-gradient (e.g., 1:500) fluid mud mound. At the water column/fluid mud interface, the solids concentration increases very abruptly from perhaps a few tenths of a part per thousand in the water to approximately 200 ppt in the fluid

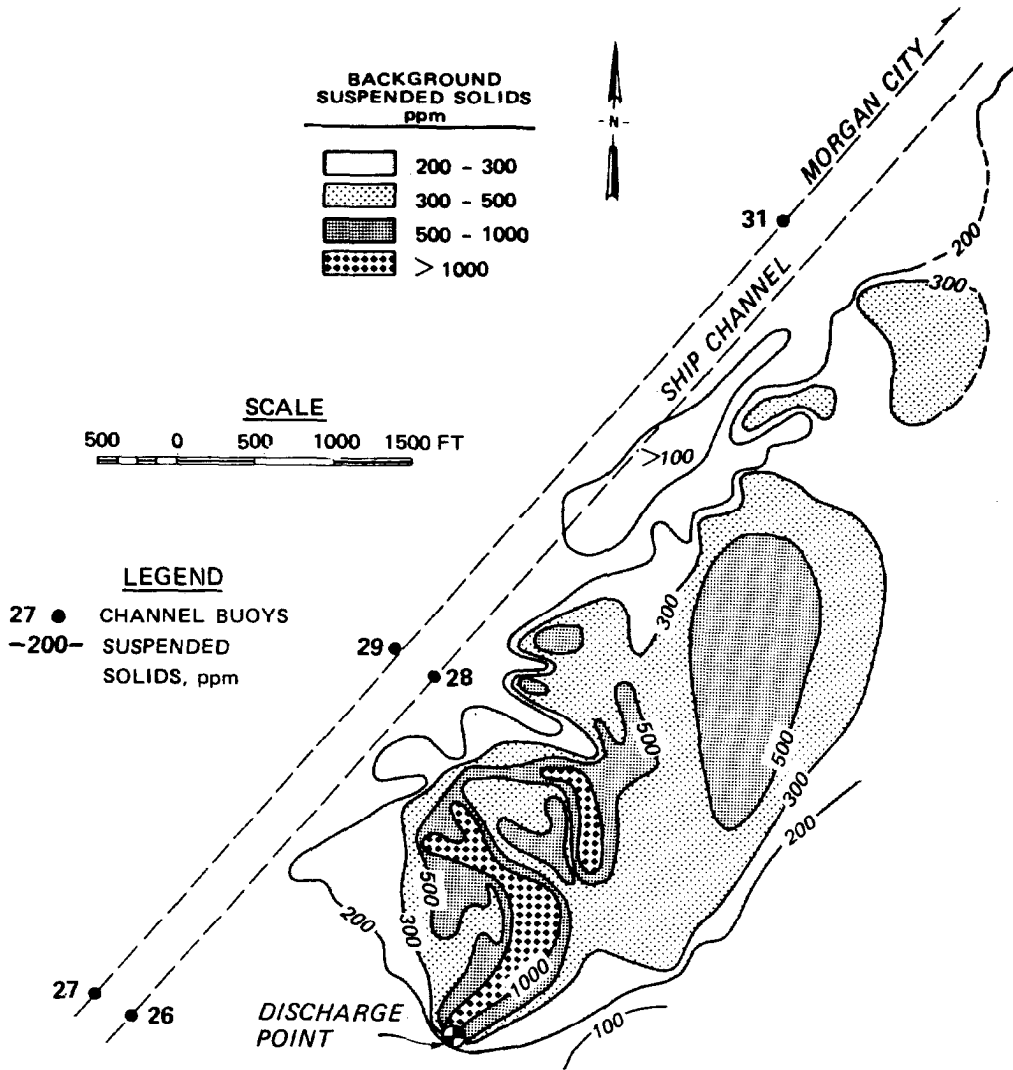

Figure 4-2. Middepth (3.0 ft) turbidity plume generated by a 28-in. pipeline disposal operation in the Atchafalaya Bay. Current flow is generally toward the northeast.

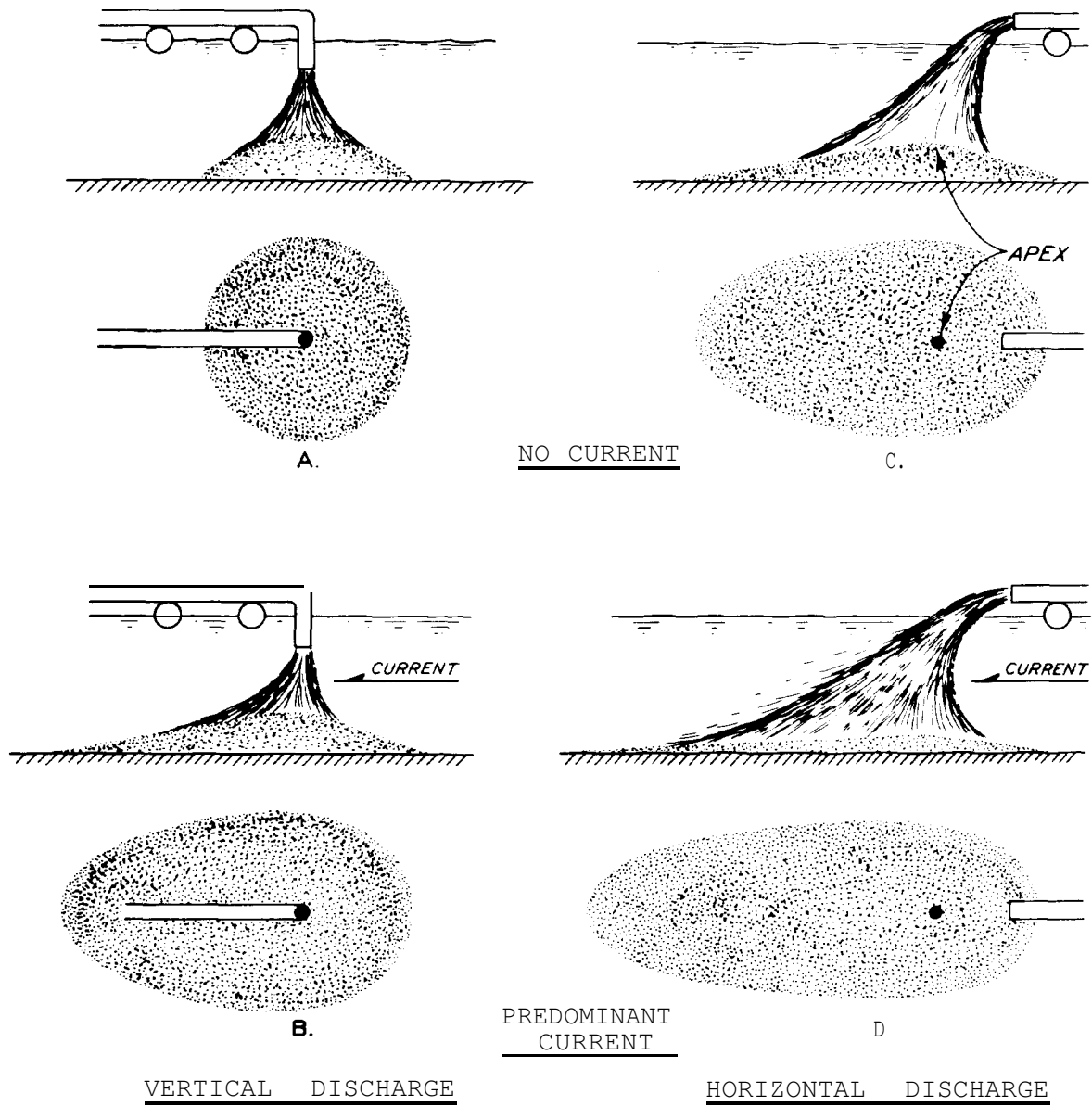

Figure 4-3. Effect of discharge angle and predominant current direction on the shape of a fluid mud mound.

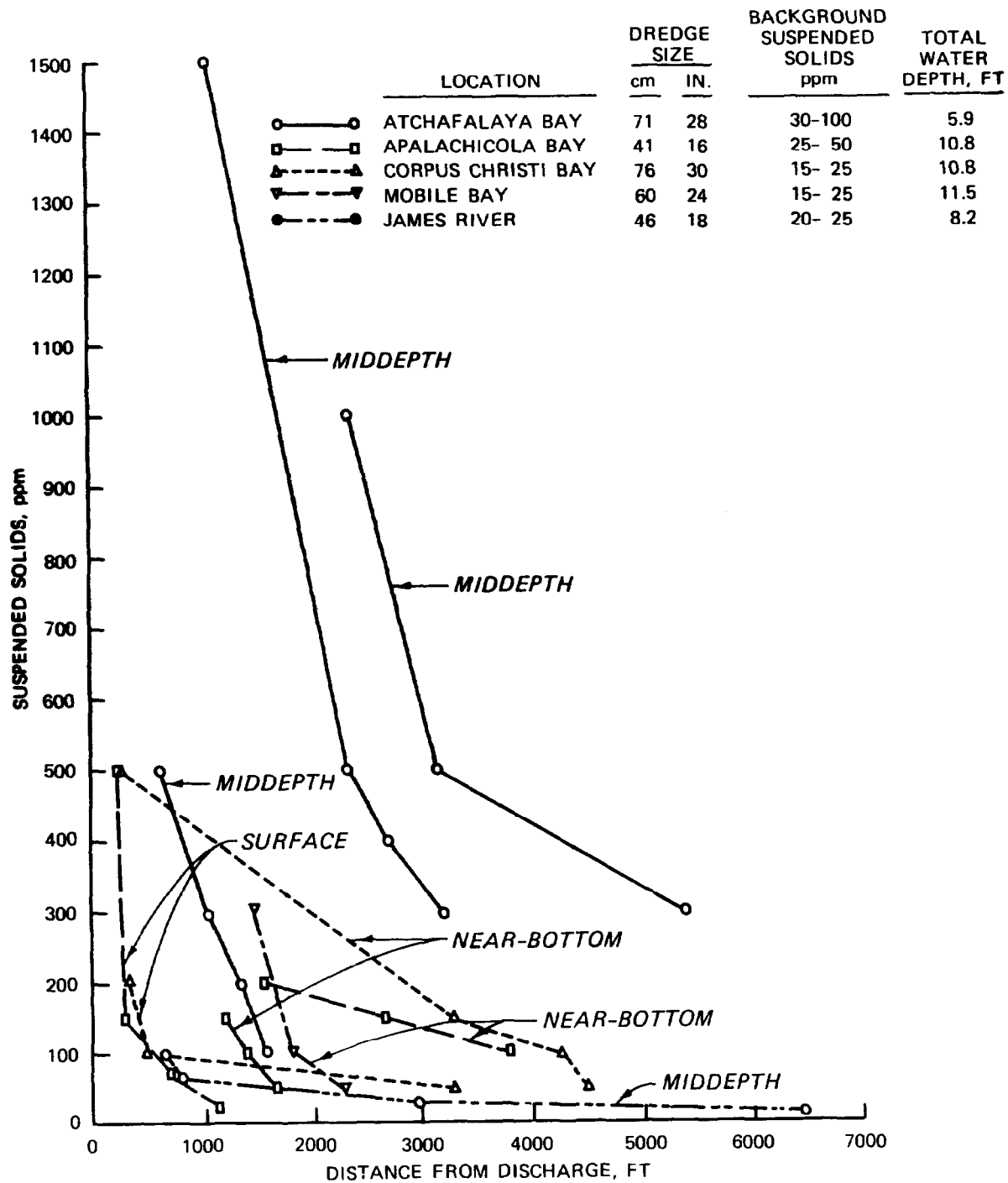

Figure 4-4. Relationship between suspended solids concentration along the plume center line and distance downcurrent from several open-water pipeline disposal operations measured at the indicated water depths,

mud. The solids concentration within the fluid mud increases above 200 ppt at a slower rate with depth until it reaches normal sediment densities. Deeper layers of fluid mud reach their final degree of consolidation more rapidly than thinner ones. Depending on the thickness of the fluid mud and its sedimentation/consolidation characteristics, complete consolidation of a fluid mud mound may require from one to several years. In those situations where material dredged by bucket or clamshell is of slurry consistency, the above description is generally applicable. More commonly, however, muddy sediments dredged by a clamshell remain in large clumps and descend to the bottom in this form. These may break apart somewhat on impact; but such material tends to accumulate in irregular mounds under the discharge vessel, rather than move outward from the discharge point. Whatever the dredging method, sandy sediments tend to mound directly beneath the discharge pipe or vessel.

d. Special Circumstances. Knowledge of the behavior of discharged dredged material allows control of the dispersion of the material at the disposal site. When minimum dispersal is desired, the dredged material can be discharged into old underwater borrow pits, sand or gravel excavation sites, etc. Such deposits may be further isolated from the overlying water column by covering with a layer of uncontaminated sediment. It is also possible to place such a covering, or "cap," over dredged material discharged onto a flat bottom.

4-7. Environmental Impacts in the Water Column.

a. Contaminants. Although the vast majority of heavy metals, nutrients, and petroleum and chlorinated hydrocarbons are usually associated with the fine-grained and organic components of the sediment (see WES TR DS-78-4), there is no biologically significant release of these chemical constituents from typical dredged material to the water column during or after dredging or disposal operations. Levels of manganese, iron, ammonium nitrogen, orthophosphate, and reactive silica in the water column may be increased somewhat for a matter of minutes over background conditions during open-water disposal operations; however, there are no persistent well-defined plumes of dissolved metals or nutrients at levels significantly greater than background concentrations.

b. Turbidity. There are now ample research results indicating that the traditional fears of water-quality degradation resulting from the resuspension of dredged material during dredging and disposal operations are for the most part unfounded. The possible impact of depressed levels of dissolved oxygen has also been of some concern, due to the very high oxygen demand associated with fine-grained dredged material slurry. However, even at open-water pipeline disposal operations where the dissolved oxygen decrease should theoretically be greatest, near-surface dissolved oxygen levels of 8 to 9 ppm will be depressed during the operation by only 2 to 3 ppm at distances of 75 to 150 ft from the discharge point. The degree of oxygen depletion generally increases with depth and increasing concentration of total suspended solids; near-bottom levels may be less than 2 ppm. However, dissolved oxygen levels usually increase with increasing distance

from the discharge point, due to dilution and settling of the suspended material.

(1) It has been demonstrated that elevated suspended solids concentrations are generally confined to the immediate vicinity of the dredge or discharge point and dissipate rapidly at the completion of the operation. If turbidity is used as a basis for evaluating the environmental impact of a dredging or disposal operation, it is essential that the predicted turbidity levels are evaluated in light of background conditions. Average turbidity levels, as well as the occasional relatively high levels that are often associated with naturally occurring storms, high wave conditions, and floods, should be considered.

(2) Other activities of man may also be responsible for generating as much or more turbidity than dredging and disposal operations. For example, each year shrimp trawlers in Corpus Christi Bay, Texas, suspend 16 to 131 times the amount of sediment that is dredged annually from the main ship channel. In addition, suspended solids levels of 0.1 to 0.5 ppt generated behind the trawlers are comparable to those levels measured in the turbidity plumes around open-water pipeline disposal operations. Resuspension of bottom sediment in the wake of large ships, tugboats, and tows can also be considerable. In fact, where bottom clearance is 3 ft or less, there may be scour to a depth of 3 ft if the sediment is easily resuspended.

4-8. Environmental Impacts on the Benthos.

a. Physical. Whereas the impact associated with water-column turbidity around dredging and disposal operations is for the most part insignificant, the dispersal of fluid mud dredged material appears to have a relatively significant short-term impact on the benthic organisms within open-water disposal areas. Open-water pipeline disposal of fine-grained dredged material slurry may result in a substantial reduction in the average abundance of organisms and a decrease in the community diversity in the area covered by fluid mud. Despite this immediate impact, recovery of the community apparently begins soon after the disposal operation ceases.

(1) Disposal operations will blanket established bottom communities at the site with dredged material which may or may not resemble bottom sediments at the disposal site. Recolonization of animals on the new substrate and the vertical migration of benthic organisms in newly deposited sediments can be important recovery mechanisms. The first organisms to recolonize dredged material usually are not the same as those which had originally occupied the site; they consist of opportunistic species whose environmental requirements are flexible enough to allow them to occupy the disturbed areas. Trends toward reestablishment of the original community are often noted within several months of disturbance, and complete recovery approached within a year or two. The general recolonization pattern is often dependent upon the nature of the adjacent undisturbed community, which provides a pool of replacement organisms capable of recolonizing the site by adult migration or larval recruitment.

(2) Organisms have various capabilities for moving upward through newly deposited sediments, such as dredged material, to reoccupy positions relative to the sediment-water interface similar to those maintained prior to burial by the disposal activity. Vertical migration ability is greatest in dredged material similar to that in which the animals normally occur and is minimal in sediments of dissimilar particle-size distribution. Bottom-dwelling organisms having morphological and physiological adaptations for crawling through sediments are able to migrate vertically through several inches of overlying sediment. However, physiological status and environmental variables are of great importance to vertical migration ability. Organisms of similar life-style and morphology react similarly when covered with an overburden. For example, most surface-dwelling forms are generally killed if trapped under dredged material overburdens, while subsurface dwellers migrate to varying degrees. Laboratory studies suggest vertical migration may very well occur at disposal sites, although field evidence is not available. Literature review (WES TR DS-78-1) indicates the vertical migration phenomenon is highly variable among species.

(3) Dredging and disposal operations have immediate localized effects on the bottom life. The recovery of the affected sites occurs over periods of weeks, months, or years, depending on the type of environment and the biology of the animals and plants affected. The more naturally variable the physical environment, especially in relation to shifting substrate due to waves or currents, the less effect dredging and disposal will have. Animals and plants common to such areas of unstable sediments are adapted to physically stressful conditions and have life cycles which allow them to withstand the stresses imposed by dredging and disposal. Exotic sediments (those in or on which the species in question does not normally live) are likely to have more severe effects when organisms are buried than sediments similar to those of the disposal site. Generally, physical impacts are minimized when sand is placed on a sandy bottom and are maximized when mud is deposited over a sand bottom. When disposed sediments are dissimilar to bottom sediments at the sites, recolonization of the dredged material will probably be slow and carried out by organisms whose life habits are adapted to the new sediment. The new community may be different from that originally occurring at the site.

(4) Dredged material discharged at disposal sites which have a naturally unstable or shifting substrate due to wave or current action is rather quickly dispersed and does not cover the area to substantial depths. This natural dispersion, which usually occurs most rapidly and effectively during the stormy winter season, can be assisted by conducting the disposal operation so as to maximize the spread of dredged material, producing the thinnest possible overburden. The thinner the layer of overburden, the easier it is for mobile organisms to survive burial by vertical migration through dredged material. The desirability of minimizing physical impacts by dispersion can be overridden by other considerations, however. For example, dredged material shown by biological or chemical testing to have a potential for adverse environmental impacts might best be placed in an area of retention, rather than dispersion. This would maximize habitat disruption in a restricted area, but would confine potentially more important chemical impacts to the same small area.

25 Mar 83

(5) Since larval recruitment and migration of adults are primary mechanisms of recolonization, recovery from physical impacts will generally be most rapid if disposal operations are completed shortly before the seasonal increase in biological activity and larval abundance in the area. The possibility of impacts can also be reduced by locating disposal sites in the least sensitive or critical habitats. This can sometimes be done on a seasonal basis. Known fish migratory routes and spawning beds should be avoided just before and during use, but might be acceptable for disposal during other periods of the year. However, care must be taken to ensure that the area returns to an acceptable condition before the next intensive use by the fish. Clam or oyster beds, municipal or industrial water intakes, highly productive backwater areas, etc., should be avoided in selecting disposal sites.

(6) All the above factors should be evaluated in selecting a disposal site, method, and season in order to minimize the habitat disruption of disposal operations. All require evaluations on a case-by-case basis by persons familiar with the ecological principles involved, as well as the characteristics of the proposed disposal operations and the local environment.

b. Contaminants.

(1) Dredging and disposal do not introduce new contaminants to the aquatic environment, but simply redistribute the sediments which are the natural depository of contaminants introduced from other sources. The potential for accumulation of a metal in the tissues of an organism (bioaccumulation) may be affected by several factors such as duration of exposure, salinity, water hardness, exposure concentration, temperature, the chemical form of the metal, and the particular organism under study. The relative importance of these factors varies from metal to metal, but there is a trend toward greater uptake at lower salinities. Elevated concentrations of heavy metals in tissues of benthic invertebrates are not always indicative of high levels of metals in the ambient medium or associated sediments. Although a few instances of uptake of possible ecological significance have been shown, the diversity of results among species, different metals, types of exposure, and salinity regimes strongly argues that bulk analysis of sediments for metal content cannot be used as a reliable index of metal availability and potential ecological impact of dredged material, but only as an indicator of total metal context. Bioaccumulation of most metals from sediments is generally minor. Levels often vary from one sample period to another and are quantitatively marginal, usually being less than one order of magnitude greater than levels in the control organisms, even after one month of exposure. Animals in undisturbed environments may naturally have high and fluctuating metal levels. Therefore, in order to evaluate bioaccumulation, comparisons should be made between control and experimental organisms at the same point in time.

(2) Organochlorine compounds such as DDT, dieldrin, and polychlorinated biphenyls (PCB's) are environmental contaminants of worldwide significance which are manmade and, therefore, do not exist naturally in the earth's crust. Organochlorine compounds are generally not soluble in surface waters at concentrations higher than approximately 20 ppb, and most of

the amount present in waterways is associated with either biological organisms or suspended solids. Organochlorine compounds are released from sediment until some equilibrium concentration is achieved between the aqueous and the solid phases and then re-adsorbed by other suspended solids or biological organisms in the water column. The concentration of organochlorines in the water column is reduced to background levels within a matter of hours as the organochlorine compounds not taken up by aquatic organisms eventually settle with the particulate matter and become incorporated into the bottom deposits in aquatic ecosystems. Most of these compounds are stable and may accumulate to relatively high concentrations in the sediments. The manufacture and/or disposal of most of these compounds is now severely limited; however, sediments that have already been contaminated with organochlorine compounds will probably continue to have elevated levels of these compounds for several decades. The low concentrations of chlorinated hydrocarbons in sediment interstitial water indicate that during dredging operations, the release of the interstitial water and contaminants to the surrounding environment would not create environmental problems. Bioaccumulation of chlorinated hydrocarbons from deposited sediments does occur. However, the sediments greatly reduce the bioavailability of these contaminants, and tissue concentrations may range from less than one to several times the sediment concentration. Unreasonable degradation of the aquatic environment due to the routine maintenance dredging and disposal of sediment contaminated with chlorinated hydrocarbons has never been demonstrated.

(3) The term "oil and grease" is used collectively to describe all components of sediments of natural and contaminant origin which are primarily fat soluble. There is a broad variety of possible oil and grease components in sediment, the analytical quantification of which is dependent on the type of solvent and method used to extract these residues. Trace contaminants, such as PCB's and chlorinated hydrocarbons, often occur in the oil and grease'. Large amounts of contaminant oil and grease find their way into the sediments of the Nation's waterways either by spillage or as chronic inputs in municipal and industrial effluents, particularly near urban areas with major waste outfalls. The literature suggests long-term retention of oil and grease residues in sediments, with minor biodegradation occurring. Where oily residues of known toxicity became associated with sediments, these sediments retained toxic properties over periods of years, affecting local biota. Spilled oils are known to readily become adsorbed to naturally occurring suspended particulates, and oil residues in municipal and industrial effluents are commonly found adsorbed to particles. These particulates are deposited in sediments and are subject to suspension during disposal. Even so, there is only slight desorption, and the amount of oil released during the elutriate test is less than 0.01 percent of the sediment-associated hydrocarbons under worst-case conditions. Selected estuarine and freshwater organisms exposed for periods up to 30 days to dredged material that is contaminated with thousands of parts per million of oil and grease experience minor mortality. Uptake of hydrocarbons from heavily contaminated sediments appears minor when compared with the hydrocarbon content of the test sediments.

(4) Ammonia is one of the potentially toxic materials known to be released from sediments during disposal; it is routinely found in evaluations

25 Mar 83

of sediments using the elutriate test and in the water near a disposal area where concentrations rapidly return to baseline levels. Similar temporary increases in ammonia at marine, estuarine, and freshwater disposal sites have been documented in several DMRP field studies, but concentrations and durations are usually well below levels causing concern.

(5) The potential environmental impact of contaminants associated with sediments must be evaluated in light of chemical and biological data describing the availability of contaminants to organisms. Information must then be gained as to the effects of specific substances on organism survival and function. Many contaminants are not readily released from sediment attachment and are thus less toxic than contaminants in the free or soluble state on which most toxicity data are based.

(6) There are now cogent reasons for rejecting many of the conceptualized impacts of disposed dredged material based on classical bulk analysis determinations. It is invalid to use total sediment concentration to estimate contaminant levels in organisms since only a variable and undetermined amount of sediment-associated contaminant is biologically available. Although a few instances of toxicity and bioaccumulation of possible ecological consequence have been seen, the fact that the degree of effect depends on species, contaminants, salinity, sediment type, etc., argues strongly that bulk analysis does not provide a reliable index of contaminant availability and potential ecological impact of dredged material.

4-9. Overview of Open-Water Disposal.

a. Prediction of physical effects of dredging and disposal is fairly straightforward. Physical effects include removal of organisms at dredging sites and burial of organisms at disposal sites. Physical effects are restricted to the immediate areas of dredging or disposal. Recolonization of sites occurs in periods of months to 1-2 years in case studies. Disturbed sites may be recolonized by opportunistic species which are not normally the dominant species occurring at the site.

b. Many organisms are very resistant to the effects of sediment suspensions in the water; aside from natural systems requiring clear water, such as coral reefs and some aquatic plant beds, dredging or disposal-induced turbidity is not of major ecological concern. The formation of fluid muds due to disposal is not fully understood and is of probable environmental concern in some situations.

c. Release of sediment-associated heavy metals and chlorinated hydrocarbons to the water column by dredging and disposal has been found to be the exception, rather than the rule. Metals are rarely bioaccumulated from sediments and then only to low levels. Chlorinated hydrocarbons may be bioaccumulated from sediments, but only very highly contaminated sediments might result in tissue concentrations of potential concern. There is little or no correlation between bulk analysis of sediments for contaminants and their environmental impact.

d. Oil and grease residues, like heavy metals, are tightly bound to sediment particles, and there appears to be minimal uptake of the residues into organism tissues. Of the thousands of chemicals constituting the oil and grease fraction, very few can be considered significant threats to aquatic life when associated with dredged material.

e. Many laboratory studies describe worst-case experimental conditions where relatively short-term exposures to high concentrations of sediments and contaminants are investigated. Although limited in scope, experimental results showing the lack of effects under these worst-case conditions support the conclusion that the indirect long-term and sublethal effects of dredging and disposal will be minimal. An integrated, whole-sediment bioassay using sensitive test organisms should be used to determine potential sediment impacts at a particular site. Appropriate chemical testing and biological evaluation of the dredged material can be used to resolve any site-specific problems which may occur.

Section IV. Confined Dredged Material Disposal

4-10. Containment Area Design.

a. Concepts of Containment Area Operation.

(1) Diked containment areas are used to retain dredged material solids while allowing the carrier water to be released from the containment area. The two objectives of a containment area are: (a) to provide adequate storage capacity to meet dredging requirements and (b) to attain the highest possible efficiency in retaining solids during the dredging operation in order to meet effluent suspended solids requirements. These considerations are interrelated and depend upon effective design, operation, and management of the containment area. Major considerations in design of containment areas are discussed below. Detailed design guidance may be found in WES TR DS-78-10.

(2) The major components of a dredged material containment area are shown schematically in figure 4-5. A tract of land is surrounded by dikes to form a confined surface area into which dredged channel sediments are pumped hydraulically. In some dredging operations, especially in the case of new work dredging, sand, clay balls, and/or gravel may be present. This coarse material rapidly falls out of suspension and forms a mound near the dredge inlet pipe. The fine-grained material (silt and clay) continues to flow through the containment area where most of the solids settle out of suspension and thereby occupy a given storage volume. The fine-grained dredged material is usually rather homogeneous and is easily characterized. The clarified water is discharged from the containment area over a weir. This effluent can be characterized by its suspended solids concentration and rate of outflow. Effluent flow rate is approximately equal to influent flow rate for continuously operating disposal areas. To promote effective sedimentation, ponded water is maintained in the area; the depth of water is controlled by the elevation of the weir crest. The thickness of the dredged material layer increases with time until the dredging operation is completed. Minimum freeboard requirements and mounding of coarse-grained

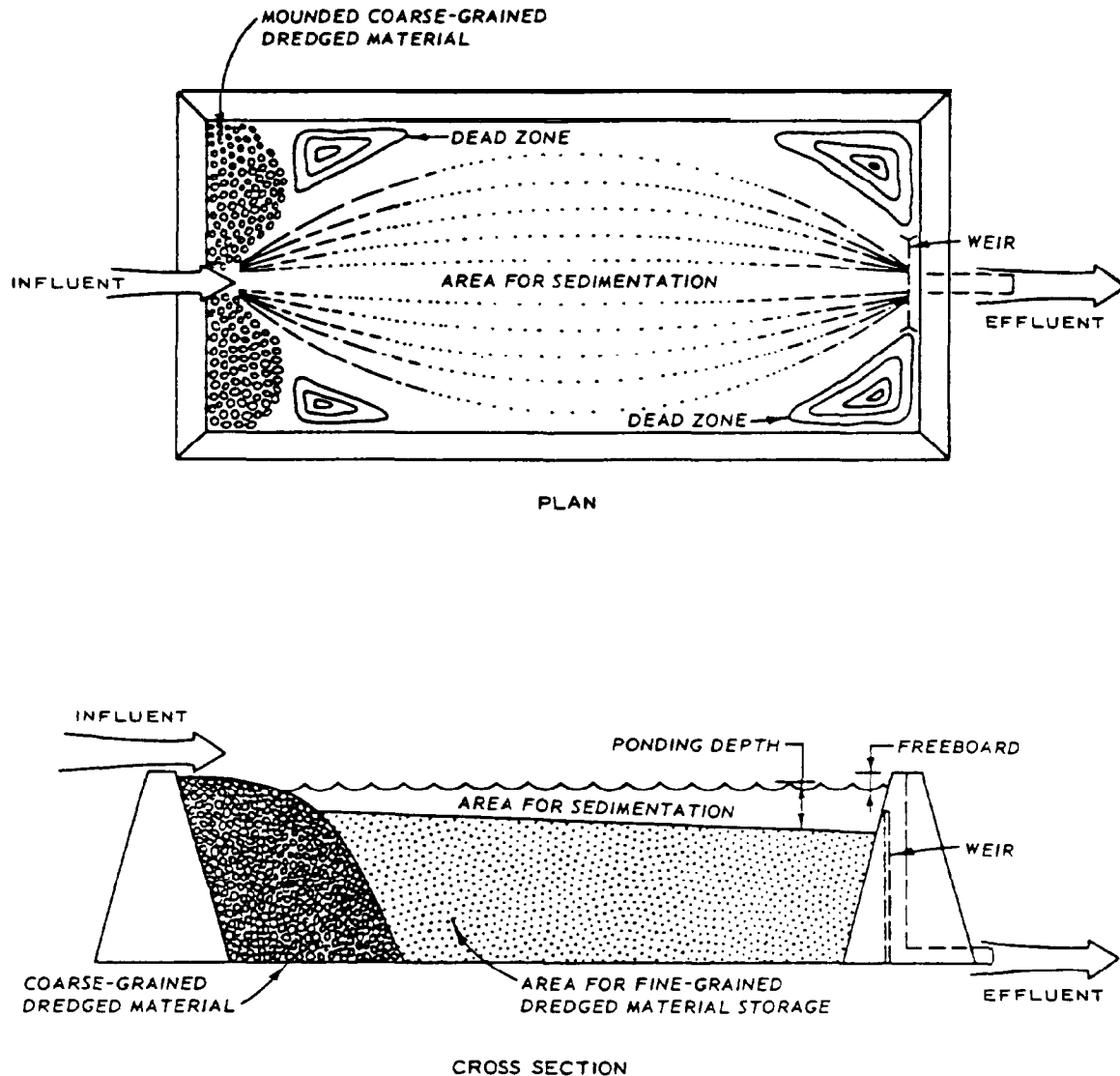

Figure 4-5. Schematic diagram of a dredged material containment area,

material result in a ponded surface area smaller than the total surface area enclosed by the dikes. In most cases, confined disposal areas must be utilized over a period of many years, storing material dredged periodically over the design life. Long-term storage capacity for these sites is influenced by consolidation of dredged material and foundation soils, dewatering of material, and effective management of the disposal area.

b. Evaluation of Dredging Activities. Effective planning and design of containment areas first requires a thorough evaluation of the dredging program. The location, volumes, frequencies, and types of material to be dredged must be estimated. The number, types, and sizes of dredges normally employed to do the work should also be considered. This information is important for defining project objectives and provides a basis for containment area design.

c. Field Investigations.

(1) Samples of the channel sediments to be dredged are required for adequate characterization of the material and for use in sedimentation and consolidation testing. The level of effort required for channel sediment sampling depends upon the project. In the case of routine maintenance work, data from prior samplings and experience with similar material may be available to reduce the scope of field investigations. Since maintenance sediments are in an essentially unconsolidated state, grab samples are normally satisfactory for sediment characterization purposes and are easy and inexpensive to obtain. For unusual maintenance projects or new work, more extensive field investigations will be required.

(2) Field investigations must also be performed at the containment area site to define foundation conditions and to obtain samples for laboratory testing if estimates of long-term storage capacity are required. The extent of required field investigations is dependent upon project size and upon foundation conditions at the site. It is particularly important to define foundation conditions, including depth, thickness, extent, and composition of foundation strata, and to obtain undisturbed samples of compressible foundation soils and any previously placed dredged material. If possible, the field investigations required for estimating long-term storage capacity should be planned and accomplished along with those required for the engineering design of the retaining dikes.

d. Laboratory Testing.

(1) Laboratory tests are required primarily to provide data for sediment characterization, containment area design, retention dike design, and long-term storage capacity estimates. The laboratory tests and procedures required are essentially standard tests and generally follow accepted procedures. The required magnitude of the laboratory testing program depends upon the project. Fewer tests are usually required when dealing with a relatively homogeneous material and/or when data are available from previous tests and experience, as is frequently the case in maintenance work. For unusual maintenance projects where considerable variation in sediment properties is apparent from samples, or for new work projects, more extensive laboratory testing programs are required. Refer to WES TR DS-78-10 for details on testing procedures.

(2) Sedimentation tests, performed in 8-in.-diameter ported columns as shown in figure 4-6, are necessary to provide design data for retention of suspended solids (item 4). These tests are designed to define the flocculent or zone-settling behavior of a particular sediment and to provide information concerning the volumes occupied by newly placed layers of dredged material. Sedimentation of freshwater sediments at slurry concentrations of less than 100 ppt can generally be characterized by flocculent settling properties. As slurry concentrations are increased, the sedimentation process may be characterized by zone-settling properties. Salinity greater than 3 ppt enhances the flocculation of dredged material particles; therefore, the settling properties of saltwater dredged material can usually be characterized by zone-settling tests. The flocculent settling test

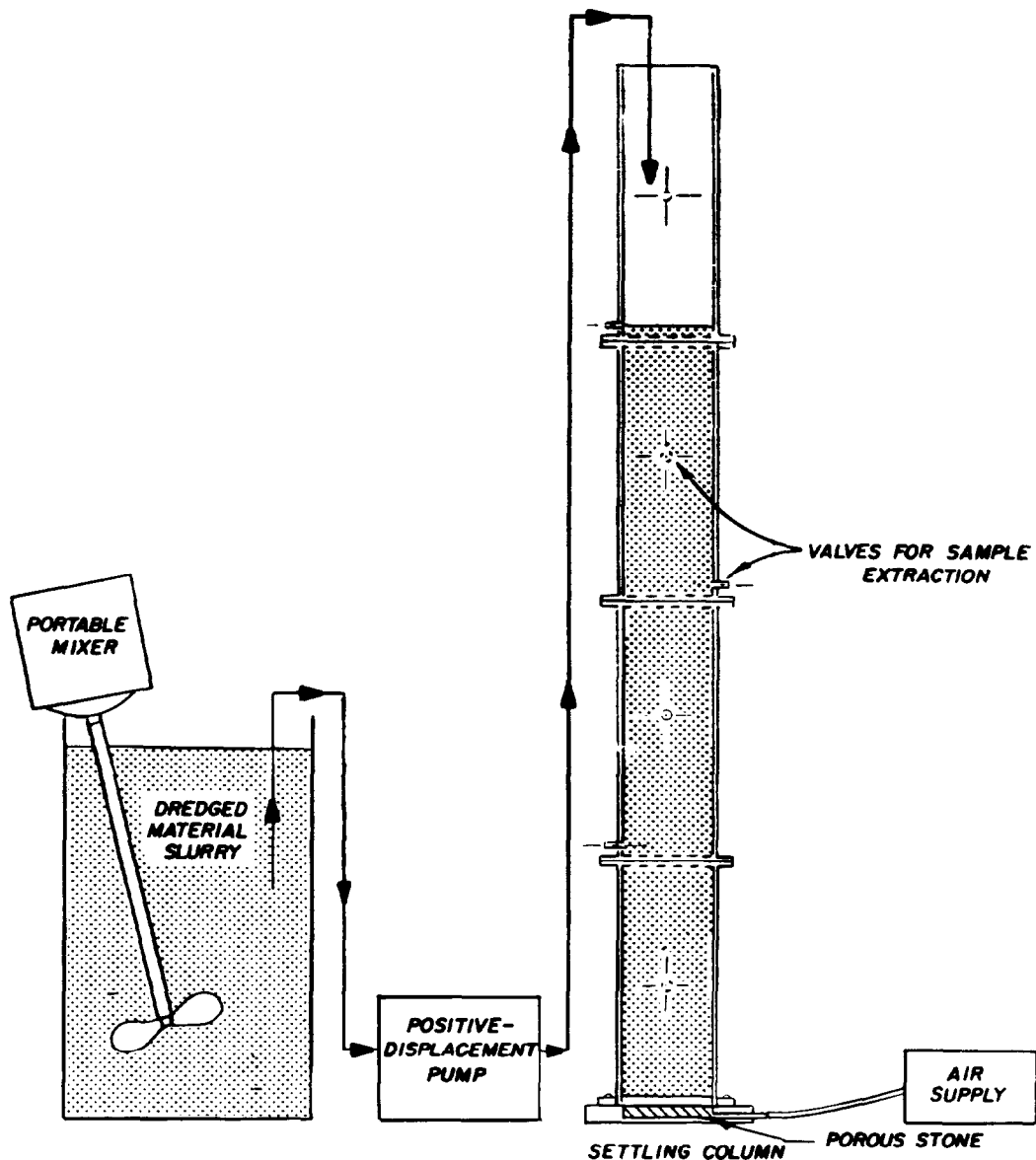

Figure 4-6. Schematic of apparatus for settling tests.

consists of measuring the concentration of suspended solids at various depths and time intervals by withdrawing samples from the settling column ports. The zone-settling test consists of placing a slurry in a settling column and timing the fall of the liquid-solids interface.

(3) Determination of containment area long-term storage capacity requires estimates of settlement due to self-weight consolidation of newly placed dredged material and due to consolidation of compressible foundation soils. Consolidation test results, including time-consolidation data, must therefore be obtained. Consolidation tests for foundation soils should be

performed as described in EM 1110-2-1906 with no modifications. The consolidation testing procedure for sediment samples generally follows that for the fixed ring test for conventional soils, but minor modifications in sample preparation and loading are required (WES TR DS-78-10).

e. Design for Retention of Suspended Solids.

(1) Sedimentation, as applied to dredged material disposal activities, refers to those operations in which the dredged material slurry is separated into more clarified water and a more concentrated slurry. Laboratory sedimentation tests must provide data for designing the containment area to meet effluent suspended solids criteria and to provide adequate storage capacity for the dredged solids. These tests are based on the gravity separation of solid particles from the transporting water.

(2) The sedimentation process can be categorized according to three basic classifications:

(a) Discrete settling. The particle maintains its individuality and does not change in size, shape, or density during the settling process.

(b) Flocculent settling. Particles agglomerate during the settling period with a change in physical properties and settling rate.

(c) Zone settling. The flocculent suspension forms a lattice structure and settles as a mass, exhibiting a distinct interface during the settling process.

(3) The important factors governing the sedimentation of dredged material solids are the initial concentration of the slurry and the flocculating properties of the solid particles. Montgomery (item 4) demonstrated by experiments that, because of the high influent solids concentration and the tendency of dredged material fine-grained particles to flocculate, either flocculate or zone-settling behavior governs sedimentation in containment areas. Discrete settling describes the sedimentation of sand particles and fine-grained sediments at concentrations much lower than those found in dredged material containment areas. Test results using the 8-in.-diameter settling column are used to design the containment area for solids retention based on principles of flocculent or zone settling. Detailed design procedures found in WES TR DS-78-10 will determine surface area, containment area volume, ponding depth, and freeboard requirements. The designs must consider the hydraulic efficiency of the containment, based on shape and topography, and the proper sizing of outlet structures.

f. Evaluation of Long-Term Storage Capacity.

(1) If the containment area is intended for one-time use, as is the case in some new work projects, estimates of long-term storage capacity are not required. However, containment areas intended for use in recurring maintenance work must be sized for long-term storage capacity over the service life of the facility. Storage capacity is defined as the total volume available to hold additional dredged material and is equal to the total

unoccupied volume minus the volume associated with ponding and freeboard requirements.

(2) The following factors must be considered in estimating long-term containment area storage capacity:

(a) After dredged material is placed within a containment area, it undergoes sedimentation and self-weight consolidation resulting in gains in storage capacity.

(b) The placement of dredged material imposes a loading on the containment area foundation, and additional settlement may result due to consolidation of compressible foundation soils.

(c) Since the consolidation process is slow, especially in the case of fine-grained materials, it is likely that total settlement will not have taken place before space in the containment area is required for additional placement of dredged material. For this reason, the time-consolidation relationship is an important consideration.

(d) Settlement of the containing dikes significantly affects the available storage capacity.

(3) Estimation of gains in long-term capacity can be made using results of laboratory consolidation tests and application of fundamental principles of consolidation modified to consider the self-weight consolidation behavior of newly placed dredged material. Detailed procedures for estimating long-term storage capacity are found in WES TR DS-78-10.

g. Weir Design. The purpose of the weir structure is to regulate release of ponded water from the containment area. Proper weir design and operation can control resuspension and withdrawal of settled solids. This is possible only if the containment areas have been properly designed to provide sufficient area and volume for sedimentation. Weirs are designed to provide selective withdrawal of the clarified upper layer of ponded water. In order to maintain acceptable effluent quality, the upper water layers containing low levels of suspended solids should be ponded at depths greater than the depth of the withdrawal zone; i.e., the area through which fluid is removed for discharge over the weir. The size of the withdrawal zone as determined by the weir location and configuration affects the velocity of flow toward the weir. Detailed considerations in weir design and design nomographs for determining required weir crest lengths are found in WES TR DS-78-10. Weirs should be structurally designed to withstand anticipated loadings at maximum ponding elevations, with consideration given to uplift forces and potential piping beneath or around the weir. Outlet pipes for the weir structure must be designed to carry flows in excess of the flow rate for the largest dredge size expected to provide for emergency release of ponded waters.

h. Chemical Clarification for Reduction of Effluent Suspended Solids.

(1) When dredged material slurry is disposed in a well-designed, well-managed containment area, the vast majority of the solids will settle out of suspension and be retained within the settling basin. However, gravity sedimentation alone will not remove all suspended solids. Any fine-grained material suspended in the ponded water above the settled solids will be discharged in the effluent water. In addition, the levels of chemical constituents in the effluent water are directly related to the amount of suspended fine-grained material; therefore, retention of fine-grained solids in the containment area results in a maximum degree of retention of potentially toxic chemical constituents. Effluent standards may require removal of suspended solids over and above that attained by gravity sedimentation.

(2) In the absence of a fully engineered treatment system, several expedient measures can be employed to enhance retention of the suspended solids within a containment area of a given size before effluent discharge. They include: intermittent pumping, increasing the depth of ponded water, increasing the effective length of the weir, temporarily discontinuing operations, or decreasing the size of the dredge.

(3) Flocculation. One method specifically for reducing the levels of fine-grained (clay-sized) suspended solids levels in the effluent involves treating the containment area effluent or the dredged material slurry with chemical flocculants to encourage the formation of flocs (i.e., particle agglomerates) that settle more rapidly than individual particles. This agglomeration or coagulation process is accomplished by an alteration of the electrochemical properties of the clay particles and the bridging of particles and small flocs by long polymer chains. Because of the large number of manufacturers of polyelectrolytes and the types available, preliminary screening of flocculants is necessary. Evaluation and determination of the optimum dose of several nontoxic polymers may be accomplished using jar-testing procedures. These procedures will indicate the most cost-effective polymer and the optimum dosage of the polymer solution for treating the suspended solids levels, as well as the optimum mixing intensities and durations for both rapid- and slow-mixing stages. Optimum detention times and surface overflow rates for clarifying the flocced suspensions and a general indication of the volume of flocced material that must be stored or re-handled can be determined from settling tests. Schroeder (item 8) presents design guidance for the use of chemical clarification methods.

i. Dike Design. Dikes for retaining or confining dredged material are normally earthen embankments similar to flood protection levees. Dike locations are usually determined by land available-for disposal areas; therefore, dikes sometimes must be constructed in areas of poor foundation quality and from materials of poor construction quality. In past years, retaining dikes for dredged material have been designed and constructed with less effort and expense than other engineered structures. The potential for dike failures and the environmental and economic damage which can result dictate that retaining dikes be properly designed and constructed using the principles of geotechnical engineering. Foundation investigations and laboratory soils tests and analyses must be conducted to design dikes to the desired degree of safety against failures. Procedures used in dike design

generally parallel those required for design of flood protection levees or earth-filled dams. WBS TR D-77-9 contains detailed guidelines for the design and construction of retaining dikes.

4-11. Containment Area Operation and Management.

a. Containment Area Operation. A major consideration in proper containment area operation is providing the ponding necessary for sedimentation and retention of suspended solids. Adequate ponding depth during the dredging operation is maintained by controlling the weir crest elevation, usually by placing boards within the weir structure. Before dredging commences, the weir should be boarded to the highest possible elevation that dike stability considerations will allow. This practice will ensure maximum possible efficiency of the containment area. The maximum elevation must allow for adequate ponding depth above the highest expected level of accumulated settled solids and yet remain below the required freeboard. If the basin is undersized or if inefficient settling is occurring in the basin, it is necessary to increase detention time and reduce approach velocity to achieve efficient settling and to avoid resuspension, respectively. Detention time can be increased by raising the weir crest to its highest elevation to increase the ponding depth; or it may be increased by operating the dredge intermittently to maintain a maximum allowable static head or depth of flow over the weir, based on the effluent quality achieved at various weir crest elevations. Once the dredging operation is completed, the ponded water must be removed to promote drying and consolidation of dredged material. Refer to WES TR DS-78-10.

b. Containment Area Management.

(1) Periodic site inspections. The importance of periodic site inspections and continuous site management following the dredging operation cannot be overemphasized. Once the dredging operation has been completed and the ponded water has been decanted, site management efforts should be concentrated on maximizing the containment storage capacity gained from continued drying and consolidation of dredged material and foundation soils. To ensure that precipitation does not pond water, the weir crest elevation must be kept at levels allowing efficient release of runoff water. This will require periodic lowering of the weir crest elevation as the dredged material surface settles.

(2) Thin-lift placement. Gains in long-term storage capacity of containment areas through natural drying processes can also be increased by placing the dredged material in thin lifts. Thin-lift placement greatly increases potential capacity through active dewatering and disposal area reuse management programs. Thin-lift placement can be achieved by obtaining sufficient land area to ensure adequate storage capacity without the need for thick lifts. It requires careful long-range planning to ensure that the large land area is used effectively for dredged material dewatering, rather than simply being a containment area whose service life is longer than that of a smaller area. Dividing a large containment area into several compartments can facilitate management; each compartment can be managed separately so that some compartments are being filled while the

dredged material in others is being dewatered. One possible management scheme for large compartmentalized containments is shown conceptually in figure 4-7. For this operation, thin lifts of dredged material are placed into each compartment in the following sequence: filling, settling and surface drainage, dewatering, and dike raising (using dewatered dredged material).

c. Dewatering and Densification.

(1) The removal of excess water from dredged material through active site management may add considerably to containment area storage volume, especially in the case of fine-grained dredged material. The most successful dewatering techniques involve efforts to accelerate natural drying and desiccation of dredged material through increased surface drainage. Dewatering efforts may be implemented in conjunction with other periodic inspection and management activities of the containment.

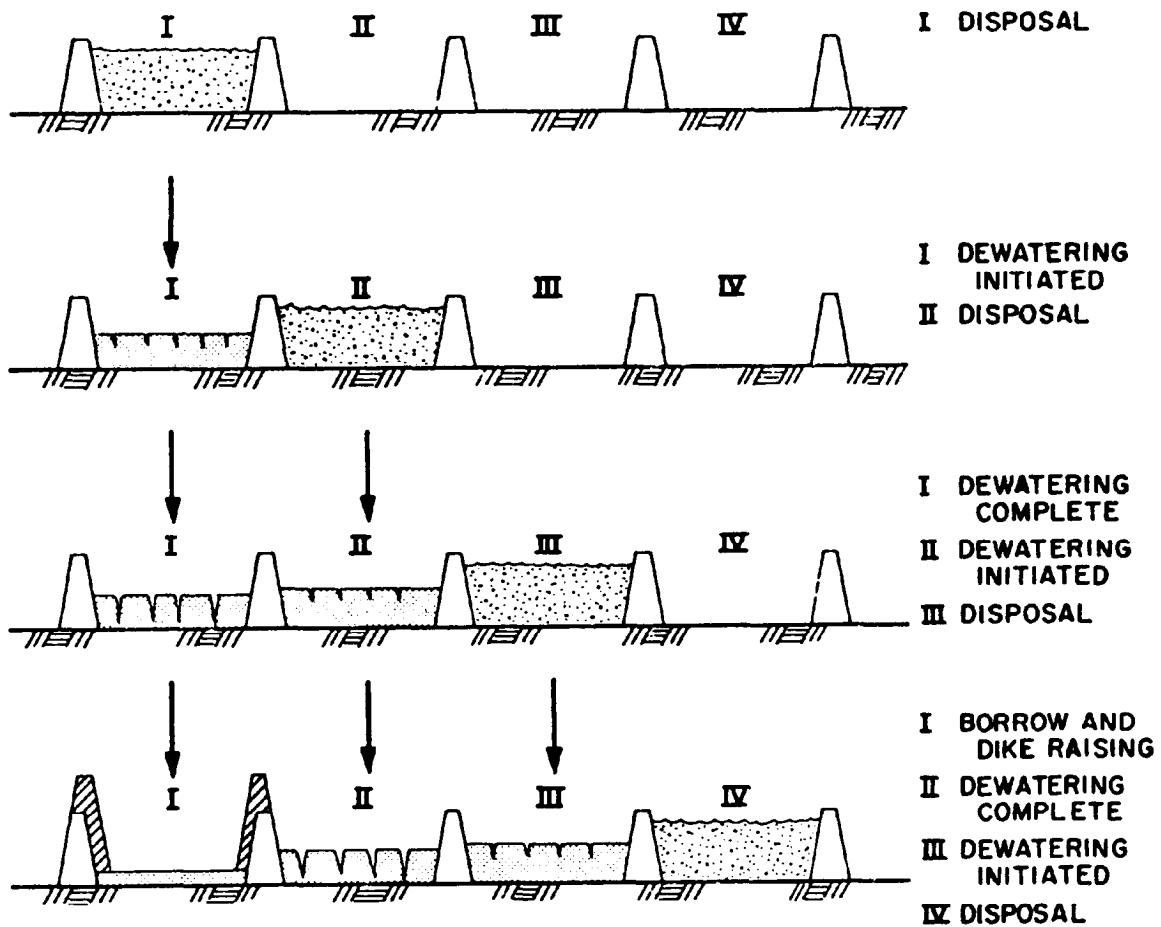

Figure 4-7. Conceptual illustration of sequential dewatering operations possible if disposal site is large enough to contain material from several periodic dredging operations.

(2) Dredged material is usually placed in confined disposal areas in a slurry state. Although a significant amount of water runs off through the overflow weirs of the disposal area, the confined fine-grained dredged material usually sediments/consolidates to only a semifluid consistency that still contains large amounts of water. Not only does the high water content greatly reduce available future disposal volume, but it also makes the dredged material unsuitable or undesirable for any commercial or productive use.

(3) Three major reasons exist for dewatering fine-grained dredged material placed in confined disposal areas:

(a) Promotion of shrinkage and consolidation to increase volume in the existing disposal site for additional dredged material.

(b) Reclamation of the dredged material into more stable soil form for removal and use in dike raising or other engineered construction, or for other productive uses, again increasing volume in the existing disposal site.

(c) Creation of stable, fast land at the disposal site itself, at a known final elevation and with predictable geotechnical properties.

(4) Allowing evaporative forces to dry fine-grained material into a crust while gradually lowering the internal water table is the least expensive and most widely applicable dewatering method. Good surface drainage, rapidly removing precipitation and preventing ponding of surface water, accelerates evaporative drying. Shrinkage forces developed during drying return the material to more stable form; lowering the internal water table results in further consolidation.

(5) Trenching. The most efficient method for promoting good surface drainage is to construct drainage trenches in the disposal area. Because several types of equipment have been found effective for progressive trenching to improve disposal area surface drainage, no unique set of trenching equipment and procedures exists. The proper equipment for any dewatering program will depend upon the following factors: size of the disposal area, whether or not desiccation crust currently exists (and, if so, of what thickness), time available for dewatering operations, type of site access, condition of existing perimeter dikes, time available between disposal cycles, and availability of and rental and operating cost for various types of trenching equipment.

(6) Underdrainage. Underdrainage is another dewatering method which may be used either individually or in conjunction with improved surface drainage. In this procedure, collector pipes are placed in either a naturally occurring or artificially placed pervious layer before dredged material disposal. Upon disposal, free water in the dredged material migrates into the pervious underdrainage layer and is removed via the collector pipe system. Although technically feasible, underdrainage may not be cost-effective in many disposal situations. Detailed discussions of dredged material dewatering are found in WES TR DS-78-11.

d. Disposal Area Reuse. Removal of coarse-grained material and dewatered fine-grained material from containment areas through proper management techniques will further add to capacity and may be implemented in conjunction with dike maintenance or raising. Removal of fine-grained dredged material is a logical followup to successful dewatering management activities and can allow partial or total reuse of the disposal area. A reusable disposal area can be regarded as a dredged material transfer station, where dredged material is collected, processed if necessary, and removed for productive use or inland disposal. The advantages provided by a reusable disposal area (one from which all or a large portion of dredged material is removed) and not by a conventional area are:

(1) Elimination or reduction of land acquisition requirements, except for inland disposal.

(2) Justification for increased costs for high-quality disposal area design and construction.

(3) Long-term availability of disposal areas near dredging sites.

(4) Availability of dredged material for use as landfill or construction material.

Detailed guidance on disposal area reuse is found in WES TR DS-78-12.

4-12. Productive Uses.

a. When planning a reusable disposal area, major consideration should be given as to how the dredged material solids will be used. If off-site productive uses could be found for all the solids being dredged, the site would theoretically have an infinite service life. The fact that dewatered dredged material is a soil, may be analyzed as a soil, and can be used as a soil encourages the productive use of dredged material as a natural resource. The following should be evaluated as potential off-site productive uses for dredged material:

(1) Landfill and construction material.

(2) Surface mine reclamation.

(3) Sanitary landfill cover material.

(4) Agricultural land enhancement.

Compatibility of dredged material with the use in question and feasibility of transport must be considered in evaluating off-site productive use. Detailed guidance is found in WES TR DS-78-21.

b. Containment areas that have been filled also have potential productive use as industrial, recreational, or waterway-related sites. Filled containment areas have been commonly used for commercial/industrial sites, and most ports have such facilities built on former dredged material

disposal sites. Recreational use of containment areas is popular because it requires minimum planning and lower cost as compared to industrial/commercial uses. In addition, the nature of recreation sites with much open space and light construction is especially suited to the weak foundation conditions associated with fine-grained dredged material. Dredged material sites may be used for purposes closely related to the maintenance, preservation, and expanded use of waterways and the surrounding lands, such as shore protection, beach nourishment, breakwaters, river control, etc. Such uses of dredged material sites are influenced by the method and sequence of the dredging operation as well as the layout of the disposal area. Waterway-related use normally involves the creation of landforms and thus permits opportunities for imaginative multiple-use site development. These landforms commonly result in a secondary recreational use.

4-13. Environmental Considerations.

a. Upland disposal of contaminated sediments must be planned to contain potentially toxic materials to control or minimize potential environmental impacts. There are four possible mechanisms for transport of contaminants from upland disposal sites:

(1) Release of contaminants in the effluent during disposal operations.

(2) Leaching into groundwater.

(3) Surface runoff of contaminants in either dissolved or suspended particulate form following disposal.

(4) Plant uptake directly from sediments, followed by indirect animal uptake from feeding on vegetation.

b. The physiochemical conditions of the dredged material at an upland disposal site may be altered substantially by the drainage of excess water. Marked changes in the chemical mobility and biological availability of some contaminants may result. In many cases, contaminant levels exceed applicable surface water quality criteria if mixing and dilution with large volumes of receiving water is limited. Almost all of the contaminants in initial dewatering effluents (with the possible exception of ammonia and manganese) are associated with suspended particulates; increasing suspended solids removal will be effective in reducing these levels.

c. Disposal sites should not be selected where subsurface drainage could result in contaminant levels exceeding applicable criteria for drinking water supplies or adjacent surface waters. Management practices to reduce leaching losses may be beneficial in some cases. Coarse-textured materials will tend to drain freely with little impediment, with time. Some fine-textured dredged material tends to form its own liner as particles settle with percolation drainage water, but it may require considerable time for self-sealing to develop; thus, an artificial liner may be useful for some upland sites. Because of the gradual self-sealing nature of many

fine-textured dredged materials, temporary liners subject to gradual deterioration with time may be adequate in many cases.

d. Plant populations may be managed to minimize uptake and environmental cycling of metals from contaminated sediments applied upland. Such a technique may be more effective where plant populations are intensively managed, as in an agricultural operation, since different species and even subspecies differ greatly in their ability to take up and translocate toxic materials. It may be possible to grow crops in which metals tend to accumulate in the plant tissue which is not harvested. Where contaminated dredged material is used to amend agricultural soil or improve other unproductive soils, liming can be an economical and effective method for reducing the bioavailability of many toxic metals.

e. Covering contaminated dredged material with clean soil or clean dredged sediments is a potential management practice that applies to all three of the major disposal alternatives. Where contaminated dredged material is to be used for habitat development, agricultural soils amendment, land reclamation, or as fill for engineering purposes, covering with clean material can be an effective method for isolating contaminants from biological populations growing in or living on the disposal site. The depth of clean material should be sufficient to isolate contaminants from plant roots and burrowing animals. Care should also be exercised to ensure that leaching from contaminated sediments into adjacent groundwater does not take place.

Section V. Habitat Development as a Disposal Alternative

4-14. General Considerations for Habitat Development.

a. Habitat development refers to the establishment of relatively permanent and biologically productive plant and animal habitats. The use of dredged material as a substrate for habitat development offers a disposal technique that is, in many situations, a feasible alternative to more conventional open-water, wetland, or upland disposal options. Refer to Smith (item 8) for more detailed information.

b. Four general habitats are suitable for establishment on dredged material : marsh, upland, island, and aquatic. Within any habitat, several distinct biological communities may occur (fig. 4-8). The determination of the feasibility of habitat development will center on the nature of the surrounding biological communities, the nature of the dredged material, and the site selection, engineering design, cost of alternatives, environmental impacts, and public approval. If habitat development is the selected alternative, a decision regarding the type or types of habitats to be developed must be made. This decision will be largely judgmental, but in general, site peculiarities will not present more than one or two logical options.

c. The selection of habitat development as a disposal alternative will be competitive with other disposal options when the following conditions exist:

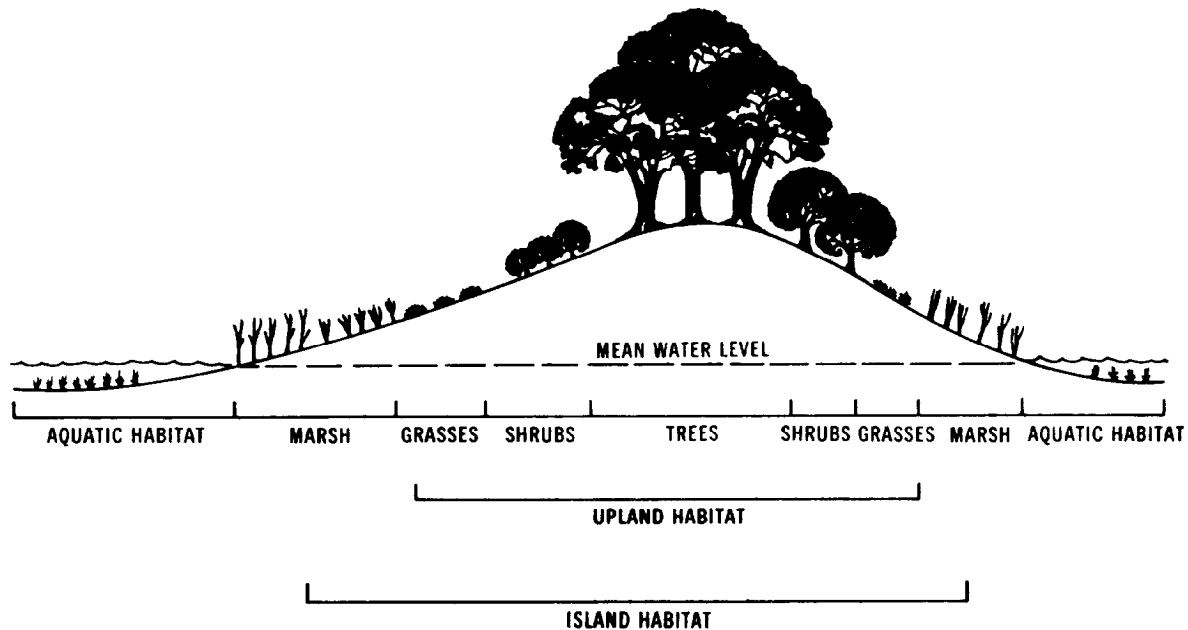

Figure 4-8. Hypothetical site illustrating the diversity of habitat types that may be developed at a disposal site,

- (1) Public/agency opinion strongly opposes other alternatives.
- (2) Recognized habitat needs exist.
- (3) Enhancement measures on existing disposal sites are identified.
- (4) Feasibility has been demonstrated locally.
- (5) Stability of dredged material deposits is desired.
- (6) Habitat development is economically feasible.

d. Disposal alternatives are often severely limited and constrained by public opinion and/or agency regulations. Constraints on open-water disposal and disposal on wetlands, or the unavailability of upland disposal sites, may leave habitat development as the most attractive alternative.

e. Habitat development may have strong public appeal when the need for restoration or mitigation or the need for additional habitat has been demonstrated. This is particularly true in areas where similar habitat of considerable value or public concern has been lost through natural processes or construction activities.

f. Habitat development may be used as an enhancement measure to improve the acceptance of a disposal technique. For example, seagrass may be planted on submerged dredged material, or wildlife food plants established on upland confined disposal sites. This alternative has considerable

potential as a low-cost mitigation procedure and may be used to offset environmental impacts incurred in disposal.

g. The concept of habitat development is more apt to be viewed as feasible if it has been successfully demonstrated locally. Even the existence of a pilot-scale project in a given locale will offset the uncertainties often present in the public perception of an experimental or unproven technique.

h. The vegetation cover provided by most habitat alternatives will often stabilize dredged material and prevent its return to the waterway. In many instances this aspect will reduce the amount of future maintenance dredging necessary at a given site and result in a positive environmental and economic impact.

i. The economic feasibility of habitat development should be considered in the context of long-term benefits. Biologically productive habitats have varied but unquestionable value (e.g., sport and commercial fisheries) and are relatively permanent features. Consequently, habitat development may be considered a disposal option with long-term economic benefits that can be applied against any additional costs incurred in its implementation. Most other disposal options lack this benefit.

j. Habitat development may be most economically competitive in situations where it is possible to take advantage of natural conditions or where minor modifications to existing methods would produce desirable biological communities. For example, the existence of a low-energy, shallow-water site adjacent to an area to be dredged may provide an ideal marsh development site and require almost no expenditure beyond that associated with open-water disposal.

4-15. Marsh Habitat Development.

a. Marshes are considered to be any community of grasses and/or herbs which experiences periodic or permanent inundation. Typically, these are intertidal fresh, brackish, or salt marshes or relatively permanently inundated freshwater marshes. Marshes are often recognized as extremely valuable natural systems and are accorded importance in food and detrital production, fish and wildlife cover, nutrient cycling, erosion control, flood-water retention, groundwater recharge, and aesthetic value. Marsh values are highly site specific and must be interpreted in terms of such variables as plant species composition, wildlife use, location, and size, which in turn influence their impact upon a given ecosystem.

b. Marsh creation has been the most studied of the habitat development alternatives, and accurate techniques have been developed to estimate costs and to design, construct, and maintain these systems. Over 100 marshes have been established on dredged material; examples are shown in figures 4-9 and 4-10. Refer to WES TR DS-78-16 for specific information on wetland habitat development. The advantages most frequently identified with marsh development are: considerable public appeal, creation of desirable biological



a. An aerial view of the 420-sq-ft freshwater marsh developed on fine-textured dredged material confined by a sand dike.



b. Within 6 months of dredged material placement, a lush growth of wetland plants had been established by natural colonization.

Figure 4-9. Windmill Point marsh development site, James River, Virginia.



a. A salt marsh was established on poorly consolidated fine-textured dredged material confined behind an earthen dike on this dredged material island.



b. Vigorous growth was obtained from sprigged smooth cordgrass and salt-meadow cordgrass.

Figure 4-10. Apalachicola Bay marsh development site.
Apalachicola Bay, Florida .

communities, considerable potential for enhancement or mitigation, and the fact that it is frequently a low-cost option.

c. Marsh development is a disposal alternative that can generate strong public appeal and has the potential for gaining wide acceptance when other techniques cannot. The habitat created has biological values that are readily identified and are accepted by many in the academic, governmental, and private sectors. However, application requires an understanding of local needs and perceptions and of the effective limits of the value of these ecosystems.

d. The potential of this alternative to replace or improve marsh habitats lost through dredged material disposal or other activities is frequently overlooked. Techniques are sufficiently advanced to design and construct productive systems with a high degree of confidence. Additionally, these habitats can often be developed with very little increase in cost above normal project operation, a fact attested to by hundreds of marshes that have been inadvertently established on dredged material.

e. The following problems are most likely to be encountered in the implementation of this alternative: unavailability of appropriate sites, loss of other habitats, release of contaminants, and loss of the site for subsequent disposal.

f. The most difficult aspect of marsh development is the location of suitable sites. Low-energy, shallow-water sites are most attractive; however, cost factors will become significant if long transport distances are necessary to reach those sites. Protective structures may be required if low-energy sites cannot be located, which can add considerably to project cost.

g. Marsh development frequently means the replacement of one desirable habitat with another, and this will likely be the source of most opposition to this alternative. There are few reliable methods of comparing the various losses and gains associated with this habitat conversion; consequently, relative impact may best be determined on the basis of the professional opinion of local authorities.

h. The potential for plants to take up contaminants and then release them into the ecosystem through consumption by animals or decomposition of plant material should be recognized when contaminated sediments are used for habitat development. Although this process has not been shown to occur often, techniques are available to determine the probability of uptake.

i. Development of a marsh at a given site can prevent the subsequent use of that area as a disposal site. In many instances, any further development on that site would be prevented by State and Federal regulations. Exceptions may occur in areas of severe erosion or where the initial disposal created a low marsh and subsequent disposal would create a higher marsh.

j. There are types of wetland habitat development other than marshes,

such as bottomland hardwoods in freshwater areas. These are addressed in WES TR DS-78-16.

4-16. Upland Habitat Development.

a. Upland habitats encompass a variety of terrestrial communities ranging from bare soil to dense forest. In its broadest interpretation, habitat occurs on all but the most disturbed upland disposal sites. For example, a gravelly and bare freshwater disposal area may provide nest sites for killdeer; weedy growth may provide cover for raccoons or a food source for seed-eating birds; and water collection in desiccation cracks may provide breeding habitat for mosquitoes. Man-made habitats will develop regardless of their management; however, the application of sound management techniques will greatly improve the quality of those habitats and the speed with which they are populated.

b. Upland habitat development has potential at hundreds of disposal sites throughout the United States. Its implementation is largely a matter of the application of well-established agricultural and wildlife management techniques. Examples of successful sites are shown in figures 4-11 and 4-12. Refer to WES TR DS-78-17 for more detailed information on upland habitat development. Upland habitat development as a disposal option has several distinct advantages, including: adaptability, improved public acceptance, creation of biologically desirable habitats, elimination of problem areas, low-cost enhancement or mitigation, and compatibility with subsequent disposal.

c. Upland habitat development may be used as an enhancement or mitigation measure at new or existing disposal sites. Regardless of the condition or location of a disposal area, considerable potential exists to convert it into a more productive habitat. For example, small sites in densely populated areas may be keyed to small animals adapted to urban life, such as seed-eating birds and squirrels. Large tracts may be managed for a variety of wildlife, including waterfowl, game mammals, and rare or endangered species.

d. The knowledge that a site will ultimately be developed into a useful area, be it a residential area, park, or wildlife habitat, improves public acceptance. Many idle and undeveloped disposal areas that are now sources of local irritation or neglect would directly benefit from upland habitat development, and such development may well result in more ready acceptance of future disposal projects.

e. In general, upland habitat development will add little to the cost of disposal operations. Standard procedures may involve liming, fertilizing, seeding, and mowing. A typical level of effort is similar to that applied for erosion control at most construction sites and considerably less than that required for levee maintenance.

f. Unless the target habitat is a long-term goal such as a forest, upland habitat development will generally be compatible with subsequent disposal operations. In most situations, a desirable vegetative cover can



Figure 4-11. Barley was planted on this sandy dredged material island in the Columbia River, Oregon, greatly improving its value to wildlife,



Figure 4-12. Sandy and silty dredged material were combined at Nott Island, Connecticut, to produce a pasture for wild geese.

be produced in one growing season. Subsequent disposal would simply require recovery of the lost habitat. Indeed, the maintenance of a particular vegetation stage may require periodic disposal to retard or set back plant succession.

g. The primary disadvantage of this alternative is related to public acceptance. The development of a biologically productive area at a given site may discourage subsequent disposal or modification of land use at that site. This problem can be avoided by the clear identification or establishment of future plans before habitat development, or by the establishment and maintenance of biological communities recognized as being most productive in the earlier stages of succession. In the latter case, subsequent disposal may be a necessary management tool.

h. Some habitat types will require management. For example, if high-productivity annual plants are selected for establishment (i.e., corn or barley as prime wildlife foods), then yearly planting will be necessary. If the intent is to maintain a grassland or open-field habitat, planting may be required only initially, but it may be necessary to mow the area every 1 to 5 years to retard colonizing woody vegetation. In most cases, it will be possible to establish very low-maintenance habitats, but if the intent is to establish and perpetuate a given habitat type, long-term management may be essential and expensive.

4-17. Island Habitat Development.

a. Dredged material islands range in size from an acre to several hundred acres. Island habitats are terrestrial communities completely surrounded by water or wetlands and are distinguished by their isolation and their limited food and cover. Because they are isolated and relatively predator-free they have particular value as nesting and roosting sites for numerous species of sea and wading birds; e.g., gulls, terns, egrets, herons, and pelicans. The importance of dredged material islands to nesting species tends to decrease as the size increases because larger islands are more likely to support resident predators. However, isolation is more important than size; and thus large isolated islands may be very attractive to nesting birds. Dredged material island habitats are pictured in figures 4-13 and 4-14. Refer to WES TR DS-78-18 for specific information regarding island habitat development.

b. Dredged material islands are found in low- to medium-energy sites throughout the United States. Typically, these are sandy islands located next to navigation channels and are characteristic of the Intracoastal Waterway. In recent years, many active dredged material islands have been diked to improve the containment characteristics of the sites.

c. The importance of dredged material islands as nesting habitats for sea and wading birds cannot be overemphasized. In some states (e.g. North Carolina and Texas) most nesting of these colonial species occurs on man-made islands.

d. Island habitat development has the following advantages: it

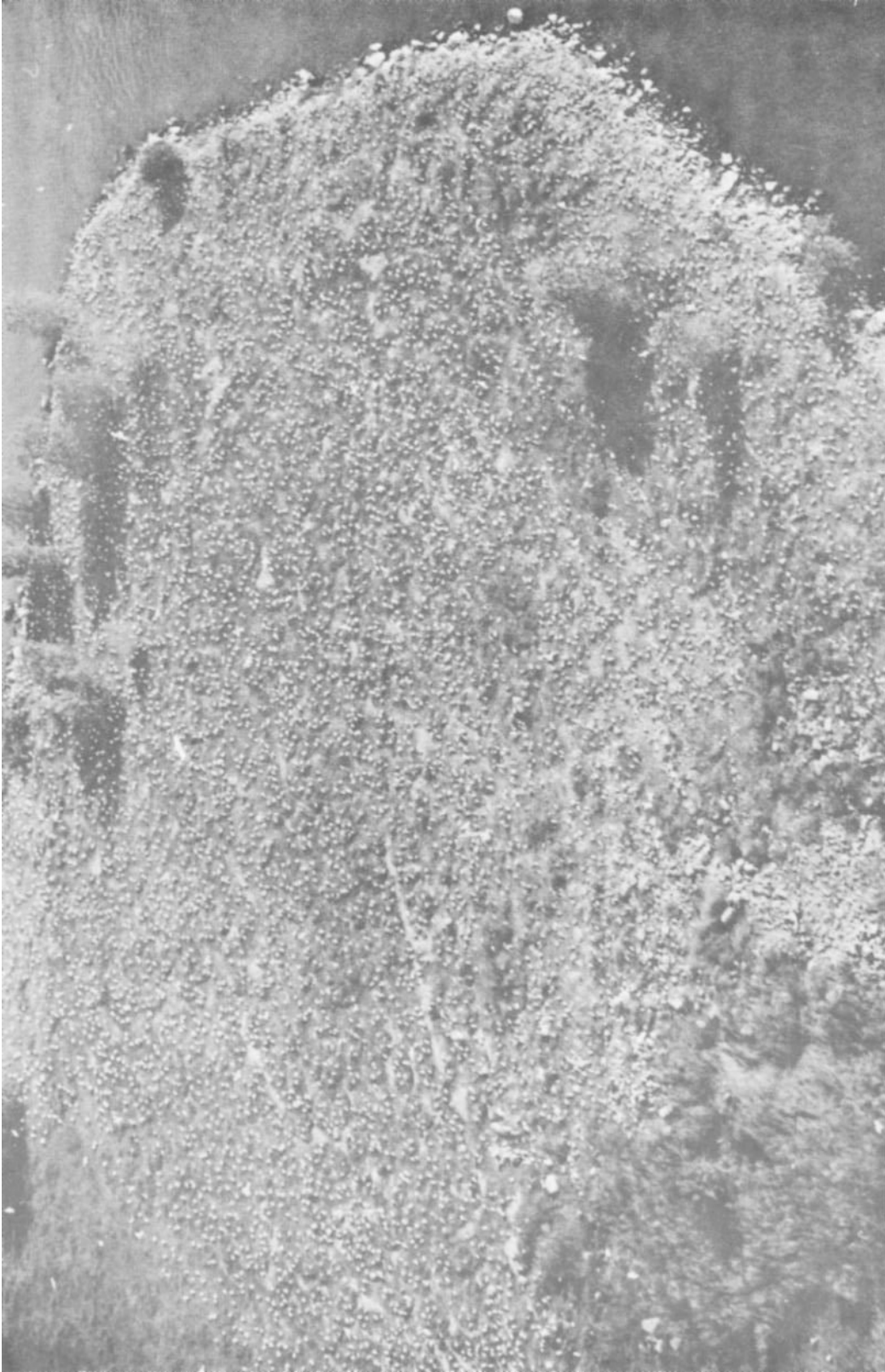

Figure 4-13. Ring-billed gull colony located on a dredged material island in the Detroit River, Michigan. The site supported 5040 nests in 1976 and 5290 nests in 1977.

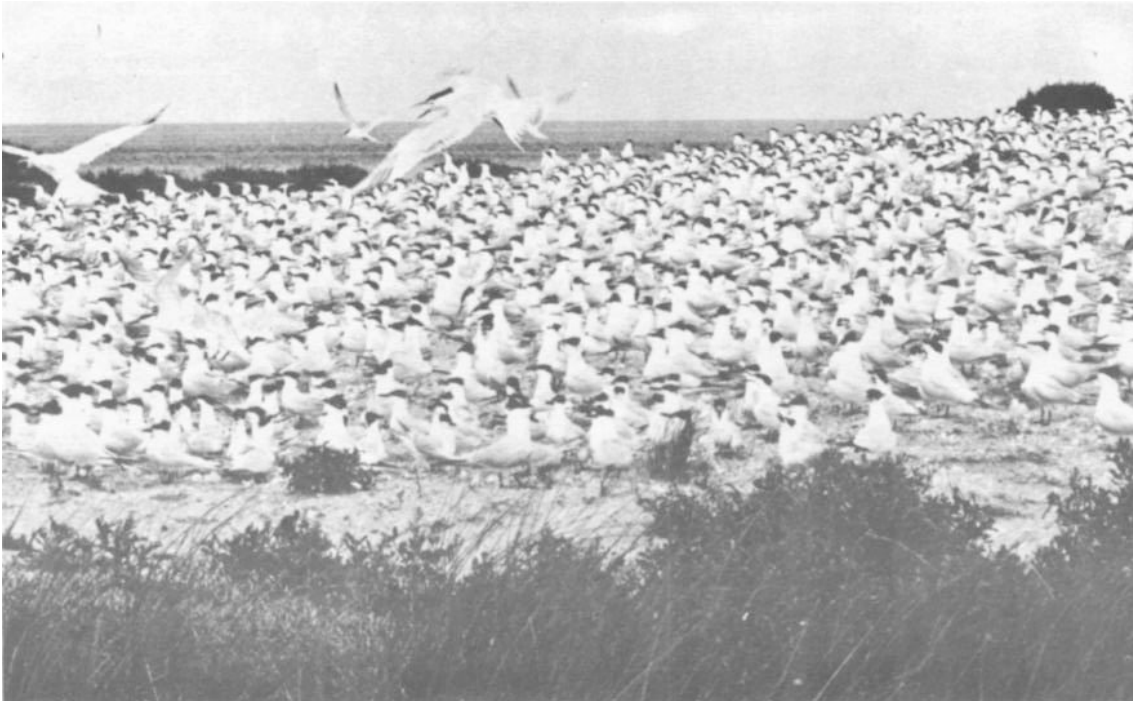

Figure 4-14. Mixed-species colony of royal and Sandwich terns located on a dredged material island in Pamlico Sound, North Carolina. The colony comprised 2988 royal tern nests and 897 Sandwich tern nests,

employs traditional disposal techniques, it permits reuse of existing disposal areas, it provides critical nesting habitats, and its management is conducive to subsequent disposal.

e. Island habitat development utilizes a traditional disposal technique : the confined or unconfined disposal of dredged material in marsh or shallow water or on existing islands. Consequently, unconventional operational problems seldom occur in its implementation.

f. In many coastal areas, the careful selection of island locales and placement will encourage use by colonial nesting birds. Properly applied, island habitat development is an important wildlife management tool: it can replace habitats lost to other resource priorities, provide new habitats where nesting and roosting sites are limiting factors, or rejuvenate existing disposal islands.

g. Planned disposal on existing dredged material islands is often conducive to their management for wildlife. Nesting is almost always keyed to a specific vegetation successional stage, and periodic disposal may be used to retard succession or set it back to a more desirable state. As a practical matter, disposal on existing islands has largely replaced new island development because of opposition to the loss of open-water and bottom

habitats. Consequently, habitat development on dredged material islands will frequently be keyed to the disposal on and management of existing islands.

h. Island habitat development has the following disadvantages: it may interrupt hydrologic processes, it may destroy open-water or marsh habitats, and it requires careful placement of material and selection of the disposal season to prevent disruption of active nesting.

i. Alteration of the water-energy regime by the placement of barriers such as islands deserves particular attention because it can change the temperature, salinity, circulation patterns, and sedimentation dynamics of the affected body of water. Large-scale projects or projects in particularly sensitive areas may warrant the development of physical, chemical, and biological models of the aquatic system before project implementation.

j. Dredged material islands, by the nature of their location, may reduce the presence of wetlands and/or open-water and their associated benthic habitats. This impact will be minimized by careful site selection or disposal on existing sites. Containment behind dikes will lessen the lateral spread of material but will probably adversely affect the value of the island to birds.

k. Disposal on any dredged material island should be immediately preceded by a visit to determine if the site is an active nesting colony. The use of dredged material islands by birds will occur with or without management. When colonies are present, scheduling of subsequent disposal operations and placement of material should be planned to minimize disruption of the disposal operations as well as of the nesting colonies involved. Destruction of the nests of all colonial waterbirds is a criminal offense punishable by fine and/or imprisonment.

4-18. Aquatic Habitat Development.

a. Aquatic habitat development refers to the establishment of biological communities on dredged material at or below mean tide. Potential developments include such communities as tidal flats, seagrass meadows, oyster beds, and clam flats. The bottoms of many water bodies could be altered using dredged material; in many cases this would simultaneously improve the characteristics of the site for selected species and permit the disposal of significant quantities of material. Planned aquatic habitat development is a relatively new and rapidly moving field; however, with the exception of many unintentional occurrences and several small-scale demonstration projects, this alternative is largely untested. There are no general texts or manuals currently available; however, potential users may obtain updated information by contacting the Environmental Laboratory at the U. S. Army Engineer Waterways Experiment Station.

b. The major advantages of aquatic development are that it produces habitats that have high biological production and potential for wide application and can effectively complement other habitats.

c. Aquatic habitats may be highly productive biological units. Seagrass beds are recognized as exceptionally valuable habitat features, providing both food and cover for many fish and shellfish. Oyster beds and clam flats have high recreational and commercial importance. Dredged material disposal projects affecting aquatic communities often incur strong criticism, and in these instances reestablishment of similar communities may be feasible as a mitigation or enhancement technique. In many instances it will be possible to establish aquatic habitats as part of marsh habitat development.

APPENDIX A
BIBLIOGRAPHY

1. Environmental Protection Agency/Corps of Engineers Technical Committee on Criteria for Dredged and Fill Material. 1978 (Apr). "Ecological Evaluation of Proposed Discharge of Dredged Material into Ocean Waters; Implementation Manual for Section 103 of Public Law 92-532 (Marine Protection, Research, and Sanctuaries Act of 1972)," U. S. Army Engineer Waterways Experiment Station, CE, Vicksburg, MS.
2. Folsom, B. L., Jr., and Lee, C. R. 1981. "Zinc and Cadmium Uptake by the Freshwater Marsh Plant *Cyperus esculentus* Grown in Contaminated Sediments Under Reduced (Flooded) and Oxidized (Upland) Disposal Conditions," Journal of Plant Nutrition, Vol. 3, pp 233-244.
3. Herbich, J. B. 1975. Coastal and Deep Ocean Dredging, Gulf Publishing Company, Texas.
4. Montgomery, R. L. 1978 (Dec). "Methodology for Design of Fine-Grained Dredged Material Containment Areas for Solids Retention," Technical Report D-78-56, U. S. Army Engineer Waterways Experiment Station, CE, Vicksburg, MS.
5. Montgomery, R. L., Horstmann, H. L., Jr., Sanderson, W. H., and McKnight, A. L. 1981 (Oct). "Problem Identification and Assessment to Determine the Need and Feasibility of an Update of the National Dredging Study," U. S. Army Engineer Waterways Experiment Station, CE, Vicksburg, MS.
6. Murden, W. R., and Goodier, J. L. 1976. "The National Dredging Study," Proceedings of WODCON VII, World Dredging Conference, San Pedro, CA.
7. Richardson, T. W. 1983. "Agitation Dredging: Lessons and Guidelines from Past Projects," Technical Report in Press, U. S. Army Engineer Waterways Experiment Station, CE, Vicksburg, MS.
8. Schroeder, P. R. 1982. "Chemical Clarification Methods for Confined Dredged Material," Technical Report in Press, U. S. Army Engineer Waterways Experiment Station, CE, Vicksburg, MS.
9. Smith, H. K. 1978 (Dec). "An Introduction to Habitat Development on Dredged Material," Technical Report DS-78-19, U. S. Army Engineer Waterways Experiment Station, CE, Vicksburg, MS.
10. Symcon Publishing Company. World Dredging and Marine Construction, San Pedro, CA.
11. Turner, T. M. 1977 (Feb). "The Bucket Wheel Hydraulic Dredge," World Dredging and Marine Construction, Vol 13, No. 3, pp 23-27.

EM 1110-2-5025
25 Mar 83

12. U. S. Army Engineer Waterways Experiment Station. 1963 (Mar). "The Unified Soil Classification System," Technical Memorandum No. 3-357, Vicksburg, MS.

APPENDIX B
CHECKLIST FOR REQUIRED STUDIES

The development of a dredging project involves the study and evaluation of many factors to assure that dredging and disposal is carried out in an efficient, economical, and environmentally compatible manner. The following are some of the factors that should be considered in the planning and design phase:

- a. Analysis of dredging locations and quantities.
- b. Dredging environment; i.e., depths, waves, currents, distance to potential disposal area, etc.
- c. Evaluation of physical, chemical, and biological characteristics of sediments to be dredged.
- d. Identification of social, environmental, and institutional factors.
- e. Evaluation of dredge plant requirements.
- f. Evaluation of potential disposal alternatives.
- g. Hydrographic surveys of proposed project.
- h. Field investigations of sediments to be dredged.
- i. Performance of required laboratory tests; i.e., chemical characterization, sedimentation, engineering properties, bioassay, bioaccumulation, etc.
- j. Evaluation of in situ density of sediments to be dredged.
- k. Evaluation of long-term dredging and disposal requirements for project.
- l. Coordination of project plans with engineering, construction-operation, and planning elements of District.
- m. Evaluation of potential productive uses of dredged material.
- n. Coordination of project plans with other agencies, public, and private groups.
- o. Evaluation of proposed project to determine potential environmental impact.