



PDH-Pro.com

## Biochemical Conversion of Lignocellulosic Biomass to Ethanol

**Course Number:** CH-02-106

**PDH:** 10

**Approved for:** AK, AL, AR, GA, IA, IL, IN, KS, KY, LA, MD, ME, MI, MN, MO, MS, MT, NC, ND, NE, NH, NJ, NM, NV, OH, OK, OR, PA, SC, SD, TN, TX, UT, VA, VT, WI, WV, and WY

New Jersey Professional Competency Approval #24GP00025600

North Carolina Approved Sponsor #S-0695

Maryland Approved Provider of Continuing Professional Competency

Indiana Continuing Education Provider #CE21800088

This document is the course text. You may review this material at your leisure before or after you purchase the course. In order to obtain credit for this course, complete the following steps:

1) Log in to My Account and purchase the course. If you don't have an account, go to New User to create an account.

2) After the course has been purchased, review the technical material and then complete the quiz at your convenience.

3) A Certificate of Completion is available once you pass the exam (70% or greater). If a passing grade is not obtained, you may take the quiz as many times as necessary until a passing grade is obtained (up to one year from the purchase date).

If you have any questions or technical difficulties, please call (508) 298-4787 or email us at [admin@PDH-Pro.com](mailto:admin@PDH-Pro.com).





# Process Design and Economics for Biochemical Conversion of Lignocellulosic Biomass to Ethanol

## Dilute-Acid Pretreatment and Enzymatic Hydrolysis of Corn Stover

D. Humbird, R. Davis, L. Tao, C. Kinchin,  
D. Hsu, and A. Aden  
*National Renewable Energy Laboratory  
Golden, Colorado*

P. Schoen, J. Lukas, B. Olthof, M. Worley,  
D. Sexton, and D. Dudgeon  
*Harris Group Inc.  
Seattle, Washington and Atlanta, Georgia*

NREL is a national laboratory of the U.S. Department of Energy, Office of Energy Efficiency & Renewable Energy, operated by the Alliance for Sustainable Energy, LLC.

**Technical Report**  
NREL/TP-5100-47764  
May 2011

Contract No. DE-AC36-08GO28308

# **Process Design and Economics for Biochemical Conversion of Lignocellulosic Biomass to Ethanol**

## **Dilute-Acid Pretreatment and Enzymatic Hydrolysis of Corn Stover**

D. Humbird, R. Davis, L. Tao, C. Kinchin,  
D. Hsu, and A. Aden  
*National Renewable Energy Laboratory  
Golden, Colorado*

P. Schoen, J. Lukas, B. Olthof, M. Worley,  
D. Sexton, and D. Dudgeon  
*Harris Group Inc.  
Seattle, Washington and Atlanta, Georgia*

Prepared under Task No. BB07.2410

**NREL is a national laboratory of the U.S. Department of Energy, Office of Energy  
Efficiency & Renewable Energy, operated by the Alliance for Sustainable Energy, LLC.**

## Executive Summary

The U.S. Department of Energy (DOE) promotes the production of ethanol and other liquid fuels from lignocellulosic biomass feedstocks by funding fundamental and applied research that advances the state of technology in biomass collection, conversion, and sustainability. As part of its involvement in the program, the National Renewable Energy Laboratory (NREL) investigates the production economics of these fuels.

This report describes in detail one potential biochemical ethanol conversion process, conceptually based upon core conversion and process integration research at NREL. The overarching process design converts corn stover to ethanol by dilute-acid pretreatment, enzymatic saccharification, and co-fermentation. Ancillary areas—feed handling, product recovery, wastewater treatment, lignin combustion, and utilities—are also included in the design. Detailed material and energy balances and capital and operating costs were developed for the entire process, and they are documented in this report and accompanying process simulation files, which are available to the public.

As a benchmark case study, this so-called technoeconomic model provides an absolute production cost for ethanol that can be used to assess its competitiveness and market potential. It can also be used to quantify the economic impact of individual conversion performance targets and prioritize these in terms of their potential to reduce cost. Furthermore, by using the benchmark as a comparison, DOE can make more informed decisions about research proposals claiming to lower ethanol production costs.

Building on design reports published in 2002 and 1999, NREL, together with the subcontractor Harris Group Inc., performed a complete review of the process design and economic model for the biomass-to-ethanol process. This update reflects NREL's current vision of the biochemical ethanol process and incorporates recent progress in the conversion areas (pretreatment, conditioning, saccharification, and fermentation), optimizations in product recovery, and an improved understanding of the ethanol plant's back end (wastewater and utilities). The major process updates in this design report are the following:

- Feedstock composition is updated to a carbohydrate profile closer to the expected mean.
- Pretreatment reactor configuration is revised with significant new detail.
- Whole-slurry pH adjustment of the pretreated biomass with ammonia replaced the previous conditioning practice of overliming, eliminating a solid-liquid separation step.
- Enzymatic hydrolysis and fermentation are modeled as a batch process with a continuous high-solids hydrolysis reactor upstream of the batch reactors.
- On-site enzyme production is included to increase transparency on the cost of enzymes.
- Wastewater treatment section is redesigned to handle inorganics in the ethanol stillage.

The conceptual design presented here reports ethanol production economics as determined by 2012 conversion targets and “*n*<sup>th</sup>-plant” project costs and financing. For the biorefinery described here, processing 2,205 dry ton/day at 76% theoretical ethanol yield (79 gal/dry ton), the ethanol selling price is \$2.15/gal in 2007\$.



# Table of Contents

<b>1</b>	<b>Introduction.....</b>	<b>1</b>
1.1	Background and Motivation .....	1
1.2	Process Overview.....	2
1.3	Technoeconomic Analysis Approach .....	5
1.4	About $n^{\text{th}}$ -Plant Assumptions .....	6
1.5	Review of Related Technoeconomic Studies .....	7
1.6	About the NREL Aspen Model.....	10
<b>2</b>	<b>Design Basis and Conventions.....</b>	<b>12</b>
2.1	Plant Size .....	12
2.2	Feedstock Composition.....	12
2.3	Design Report Conventions .....	15
2.3.1	Units .....	15
2.3.2	Total Solids Loading.....	15
2.3.3	Ethanol Density .....	15
2.3.4	Theoretical Yields and Conversions .....	15
<b>3</b>	<b>Process Design and Cost Estimation Details.....</b>	<b>16</b>
3.1	Area 100: Feedstock Storage and Handling.....	16
3.1.1	Overview .....	16
3.1.2	Design Basis.....	17
3.1.3	Cost Estimation .....	17
3.2	Area 200: Pretreatment and Conditioning .....	19
3.2.1	Overview .....	19
3.2.2	Design Basis.....	20
3.2.3	Cost Estimation .....	22
3.2.4	Achieving the Design Case .....	23
3.3	Area 300: Enzymatic Hydrolysis and Fermentation .....	26
3.3.1	Overview .....	26
3.3.2	Design Basis.....	27
3.3.3	Cost Estimation .....	31
3.3.4	Achieving the Design Case .....	32
3.4	Area 400: Cellulase Enzyme Production .....	36
3.4.1	Overview .....	36
3.4.2	Design Basis.....	37
3.4.3	Cost Estimation .....	40
3.4.4	Enzyme Cost Discussion.....	40
3.5	Area 500: Product, Solids, and Water Recovery .....	44
3.5.1	Overview .....	44
3.5.2	Design Basis.....	45
3.5.3	Cost Estimation .....	46
3.6	Area 600: Wastewater Treatment (WWT).....	47
3.6.1	Overview .....	47
3.6.2	Design Basis.....	48
3.6.3	Cost Estimation .....	50
3.6.4	Wastewater Challenges .....	50
3.7	Area 700: Product and Feed Chemical Storage .....	51

3.7.1 Overview .....	51
3.7.2 Design Basis .....	51
3.7.3 Cost Estimation .....	51
3.8 Area 800: Combustor, Boiler, and Turbogenerator .....	52
3.8.1 Overview .....	52
3.8.2 Design Basis .....	52
3.8.3 Cost Estimation .....	53
3.9 Area 900: Utilities .....	54
3.9.1 Overview .....	54
3.9.2 Design Basis .....	54
3.9.3 Cost Estimation .....	56
<b>4 Process Economics .....</b>	<b>57</b>
4.1 About Cost-Year Indices .....	57
4.2 Total Capital Investment (TCI) .....	58
4.3 Variable Operating Costs .....	62
4.4 Fixed Operating Costs .....	64
4.5 Discounted Cash Flow Analysis and the Minimum Selling Price of Ethanol .....	65
<b>5 Analysis and Discussion .....</b>	<b>70</b>
5.1 Carbon and Energy Balance .....	70
5.2 Water Balance .....	74
5.3 The Cost of Sugar .....	76
5.4 Cost Sensitivity Analysis .....	79
5.5 State of Technology Back-Casting .....	81
<b>6 Concluding Remarks .....</b>	<b>83</b>
6.1 Summary .....	83
6.2 Variance from the 2002 Design .....	84
6.3 Future Work .....	85
<b>References .....</b>	<b>87</b>
<b>Appendix A. Individual Equipment Costs Summary .....</b>	<b>96</b>
<b>Appendix B. Discounted Cash Flow Rate of Return Worksheet .....</b>	<b>103</b>
<b>Appendix C. Process Parameters/Operating Summary .....</b>	<b>106</b>
<b>Appendix D. Aspen Properties .....</b>	<b>107</b>
<b>Appendix E. Process Flow Diagrams .....</b>	<b>114</b>

## List of Figures

Figure 1. Simplified flow diagram of the overall process, PFD-P120-A000 .....	4
Figure 2. NREL’s approach to process design and economic analysis .....	5
Figure 3. Adjusting the Kazi et al. base case (\$3.40/gal) to NREL 2008 SOT assumptions.....	10
Figure 4. Structural carbohydrate distribution of the feedstock variability study [25].....	13
Figure 5. Simplified flow diagram of the feedstock receiving system .....	16
Figure 6. Simplified flow diagram of the pretreatment and conditioning process .....	19
Figure 7. Horizontal pretreatment reactor design scheme (Andritz, Inc.) .....	23
Figure 8. Simplified flow diagram of the enzymatic hydrolysis and fermentation process .....	27
Figure 9. Simplified flow diagram of the enzyme production process.....	36
Figure 10. Enzyme production cost breakdown .....	41
Figure 11. Enzyme contribution to MESP as a function of loading .....	42
Figure 12. Simplified flow diagram of the separation process .....	44
Figure 13. Simplified flow diagram of the wastewater treatment process .....	47
Figure 14. Cooling duty distribution between major users.....	55
Figure 15. Distribution of plant electricity utilization by process area.....	56
Figure 16. Sensitivity of MESP to IRR and % equity (8% interest on a 10-year loan).....	66
Figure 17. Cost contribution details from each process area (per gallon EtOH).....	69
Figure 18. Mass, carbon, and energy balance diagram for the overall process .....	73
Figure 19. Economic summary for dilute sugar production .....	78
Figure 20. Single-point sensitivity tornado charts for (a) MESP and (b) ethanol yield .....	80
Figure 21. Sugar-based pathways for conventional and advanced biofuels .....	86



## List of Tables

Table 1. Comparison of Technoeconomic Analyses and Market Studies for Existing Biofuels....	7
Table 2. Survey of Recent Technoeconomic Studies on Biochemical Cellulosic Ethanol .....	9
Table 3. Summary of Whole Stover Composition Data .....	13
Table 4. Corn Stover Composition from the 2002 Design [2] and the Present Design.....	14
Table 5. Pretreatment Reactor Conditions.....	21
Table 6. Pretreatment Hydrolysis Reactions and Assumed Conversions .....	22
Table 7. Research Status and 2012 Targets in the Pretreatment Area .....	24
Table 8. Enzymatic Hydrolysis Conditions .....	28
Table 9. Enzymatic Hydrolysis Reactions and Assumed Conversions .....	28
Table 10. Seed Train Specifications .....	29
Table 11. Seed Train Reactions and Assumed Conversions.....	29
Table 12. Co-Fermentation Contamination Loss Reactions.....	30
Table 13. Co-Fermentation Conditions.....	31
Table 14. Co-Fermentation Reactions and Assumed Conversions.....	31
Table 15. Research Status and 2012 Targets in Enzymatic Hydrolysis and Fermentation .....	32
Table 16. Summary of Integrated Whole-Slurry Enzymatic Hydrolysis Performance Using an Advanced Enzyme Preparation.....	33
Table 17. Ethanol Yields from Xylose .....	34
Table 18. Area 400 Guiding Design Basis Assumptions.....	37
Table 19. Specifications of the Enzyme Production Bioreactors .....	39
Table 20. Cellulase Production Nutrient Requirements .....	39
Table 21. Cellulase Production Electricity Requirements .....	40
Table 22. Wastewater Treatment System Design Basis .....	48
Table 23. Storage Requirements.....	51
Table 24. Cooling Water Users.....	54
Table 25. Installation Factors.....	59
Table 26. Scaling Exponents.....	60
Table 27. Additional Costs for Determining Total Capital Investment (TCI).....	61
Table 28. Project Cost Worksheet Including Total Direct Costs and Total Capital Investment ..	62
Table 29. Chemical Costs and Sources.....	63
Table 30. Variable Operating Costs.....	63
Table 31. Fixed Operating Costs .....	64
Table 32. Construction Activities and Cash Flow .....	67
Table 33. Discounted Cash Flow Analysis Parameters .....	68
Table 34. Summary of Yields, Rates, and Conversion Costs .....	69
Table 35. Ethanol Plant Overall Carbon Balance .....	70
Table 36. Ethanol Plant Overall Energy Balance .....	71
Table 37. Ethanol Plant Water Balance .....	75
Table 38. Individual Contributors to Cooling Water Evaporation .....	75
Table 39. Mixed Sugar Stream Composition.....	77
Table 40. Assumptions Varied in the Sensitivity Analysis.....	79
Table 41. Back-Casted State of Technology Cases and Future Targets.....	82
Table 42. Comparison of the Previous Target Case and the Present Design (2007\$/gal) .....	84
Table 43. Individual Contributors to the Change in MESP .....	85

## Acronyms

AFEX	ammonia fiber explosion
BFW	boiler feed water
BLS	Bureau of Labor Statistics
C5/C6	refers to mixtures of xylose (a C5 sugar) and glucose (a C6 sugar)
CBP	consolidated bioprocessing
CIP	clean-in-place
COD	chemical oxygen demand
CSL	corn steep liquor
DAP	diammonium phosphate
DCFROR	discounted cash flow rate of return
DOE	U.S. Department of Energy
FCI	fixed capital investment
FGD	flue gas desulfurization
HHV	higher heating value
HMF	5-hydroxymethyl furfural
INL	Idaho National Laboratory
IRR	internal rate of return
ISBL	inside battery limits (of the plant)
LHV	lower heating value
MESP	minimum ethanol selling price
MM	million (e.g., MMBtu or \$__MM)
MSSP	minimum sugar selling price
MYPP	OBP's Multi-Year Program Plan
NPV	net present value
NREL	National Renewable Energy Laboratory
OBP	Office of the Biomass Program
OTR	oxygen transfer rate
OUR	oxygen uptake rate
PCS	pretreated corn stover
PFD	process flow diagram
SCFM	standard cubic feet per minute
SHF	separate (or sequential) hydrolysis and fermentation
SOT	annual State of Technology case
SSCF	simultaneous saccharification and co-fermentation
TCI	total capital investment
TDC	total direct cost
TE	technoeconomic
VOC	volatile organic compound
VVM	volume (of gas) per volume (of liquid) per minute
WWT	wastewater treatment

# 1 Introduction

## 1.1 Background and Motivation

The U.S. Department of Energy (DOE) Office of the Biomass Program (OBP) promotes the production of ethanol and other liquid fuels from lignocellulosic feedstocks by sponsoring programs in fundamental and applied research that aim to advance the state of biomass conversion technology. These programs include laboratory campaigns to develop better cellulose hydrolysis enzymes and fermenting microorganisms, detailed engineering studies of potential processes, and construction of pilot-scale demonstration and production facilities. This research is conducted by national laboratories, universities, and private industry in conjunction with engineering and construction companies.

As part of its involvement in the program, the National Renewable Energy Laboratory (NREL) investigates the complete process design and economics of cellulosic ethanol manufacturing in order to develop an absolute plant-gate price for ethanol based on process and plant design assumptions consistent with applicable best practices in engineering, construction, and operation. This plant-gate price is referred to as the minimum ethanol selling price or MESP. The MESP can be used by policymakers and DOE to assess the cost-competitiveness and market penetration potential of cellulosic ethanol in comparison with petroleum-derived fuels and starch- or sugar-based ethanol.

The technoeconomic analysis effort at NREL also helps to direct our biomass conversion research by examining the sensitivity of the MESP to process alternatives and research advances. Proposed research and its anticipated results can be translated into a new MESP that can be compared to the benchmark case documented in this report. Such comparison helps to quantify the economic impact of core research targets at NREL and elsewhere and to track progress toward meeting competitive cost targets. It also allows DOE to make more informed decisions about research proposals that claim to reduce MESP.

This report builds upon previous issues from 1999 [1] and 2002 [2] written by NREL engineers with Delta-T, Merrick Engineering, Reaction Engineering, Inc., and Harris Group. For the present report, NREL again contracted Harris Group to provide engineering support for estimating and reviewing the equipment and raw material costs used in the process design. This update reflects NREL's latest envisioned biochemical ethanol process and includes recent research progress in the conversion areas (pretreatment, conditioning, enzymatic hydrolysis, and fermentation), optimizations in product recovery, and our latest understanding of the ethanol plant's back end (separation, wastewater, and utilities). NREL worked with Harris Group to identify realistic configurations and costs for critical equipment, the pretreatment reactor system in particular. An on-site cellulase enzyme section was included in this update to permit better transparency of enzyme economics than the fixed cost contribution assumed in the last design report did.

The biomass conversion efficiencies used in the design (e.g., cellulose to glucose or xylose to ethanol) are based on a slate of research targets that NREL and DOE have committed to demonstrate by the end of 2012 in a campaign of integrated pilot-scale runs. These 2012 performance targets are discussed in detail in this report. The economics of this conceptual process use the best available equipment and raw material costs and an " $n^{\text{th}}$ -plant" project cost

structure and financing. The projected 2012  $n^{\text{th}}$ -plant MESP computed in this report is \$2.15/gal in 2007\$.

Modifications to the conceptual process design presented here will be reflected annually through NREL's State of Technology (SOT) reports. These ensure that the process design and its cost benchmark incorporate the most current data from NREL and other DOE-funded research and that equipment costs stay up-to-date.

We stress that this design report serves to describe a *single, feasible* cellulosic ethanol conversion process and to transparently document the assumptions and details that went into its design. This report is not meant to provide an exhaustive survey of process alternatives or cost-sensitivity analyses. These will be investigated in separate papers that extend and reference the present report. Furthermore, the process models and economic tools developed for this report are available to the public, and the authors and members of NREL's Biochemical Platform Analysis task will provide support to researchers who wish to use them for their own studies.

## 1.2 Process Overview

The process described here uses co-current dilute-acid pretreatment of lignocellulosic biomass (corn stover), followed by enzymatic hydrolysis (saccharification) of the remaining cellulose, followed by fermentation of the resulting glucose and xylose to ethanol. The process design also includes feedstock handling and storage, product purification, wastewater treatment, lignin combustion, product storage, and required utilities. The process is divided into nine areas (see Figure 1).

- *Area 100: Feed handling.* The feedstock, in this case milled corn stover, is delivered to the feed handling area from a uniform-format feedstock supply system. Only minimum storage and feed handling are required. From there, the biomass is conveyed to the pretreatment reactor (Area 200).
- *Area 200: Pretreatment and conditioning.* In this area, the biomass is treated with dilute sulfuric acid catalyst at a high temperature for a short time to liberate the hemicellulose sugars and break down the biomass for enzymatic hydrolysis. Ammonia is then added to the whole pretreated slurry to raise its pH from ~1 to ~5 for enzymatic hydrolysis.
- *Area 300: Enzymatic hydrolysis and fermentation.* Enzymatic hydrolysis is initiated in a high-solids continuous reactor using a cellulase enzyme prepared on-site. The partially hydrolyzed slurry is next batched to one of several parallel bioreactors. Hydrolysis is completed in the batch reactor, and then the slurry is cooled and inoculated with the co-fermenting microorganism *Zymomonas mobilis*. After a total of five days of sequential enzymatic hydrolysis and fermentation, most of the cellulose and xylose have been converted to ethanol. The resulting beer is sent to the product recovery train (Area 500).
- *Area 400: Cellulase enzyme production.* An on-site enzyme production section was included in this design. Purchased glucose (corn syrup) is the primary carbon source for enzyme production. Media preparation involves a step in which a portion of the glucose is converted to sophorose to induce cellulase production. The enzyme-producing fungus (modeled after *Trichoderma reesei*) is grown aerobically in fed-batch bioreactors. The

entire fermentation broth, containing the secreted enzyme, is fed to Area 300 to carry out enzymatic hydrolysis.

- *Area 500: Product recovery.* The beer is separated into ethanol, water, and residual solids by distillation and solid-liquid separation. Ethanol is distilled to a nearly azeotropic mixture with water and then purified to 99.5% using vapor-phase molecular sieve adsorption. Solids recovered from the distillation bottoms are sent to the combustor (Area 800) while the liquid is sent to wastewater treatment (Area 600).
- *Area 600: Wastewater treatment.* Plant wastewater streams are treated by anaerobic and aerobic digestion. The methane-rich biogas from anaerobic digestion is sent to the combustor (Area 800), where sludge from the digesters is also burned. The treated water is suitable for recycling and is returned to the process.
- *Area 700: Storage.* This area provides bulk storage for chemicals used and produced in the process, including corn steep liquor (CSL), ammonia, sulfuric acid, nutrients, water, and ethanol.
- *Area 800: Combustor, boiler, and turbogenerator.* The solids from distillation and wastewater treatment and the biogas from anaerobic digestion are combusted to produce high-pressure steam for electricity production and process heat. The majority of the process steam demand is in the pretreatment reactor and distillation columns. The boiler produces excess steam that is converted to electricity for use in the plant and for sale to the grid.
- *Area 900: Utilities.* This area includes a cooling water system, chilled water system, process water manifold, and power systems.

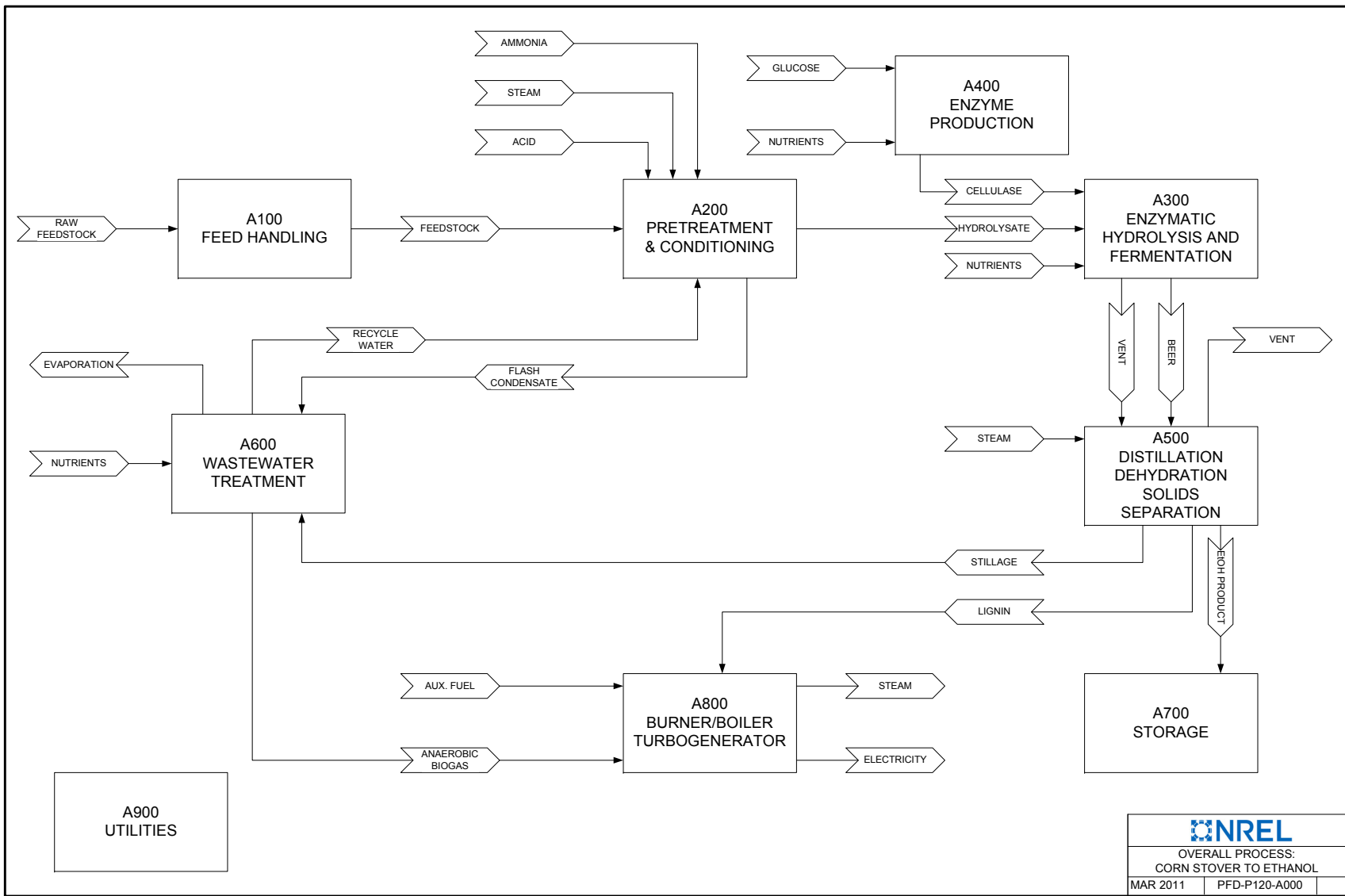
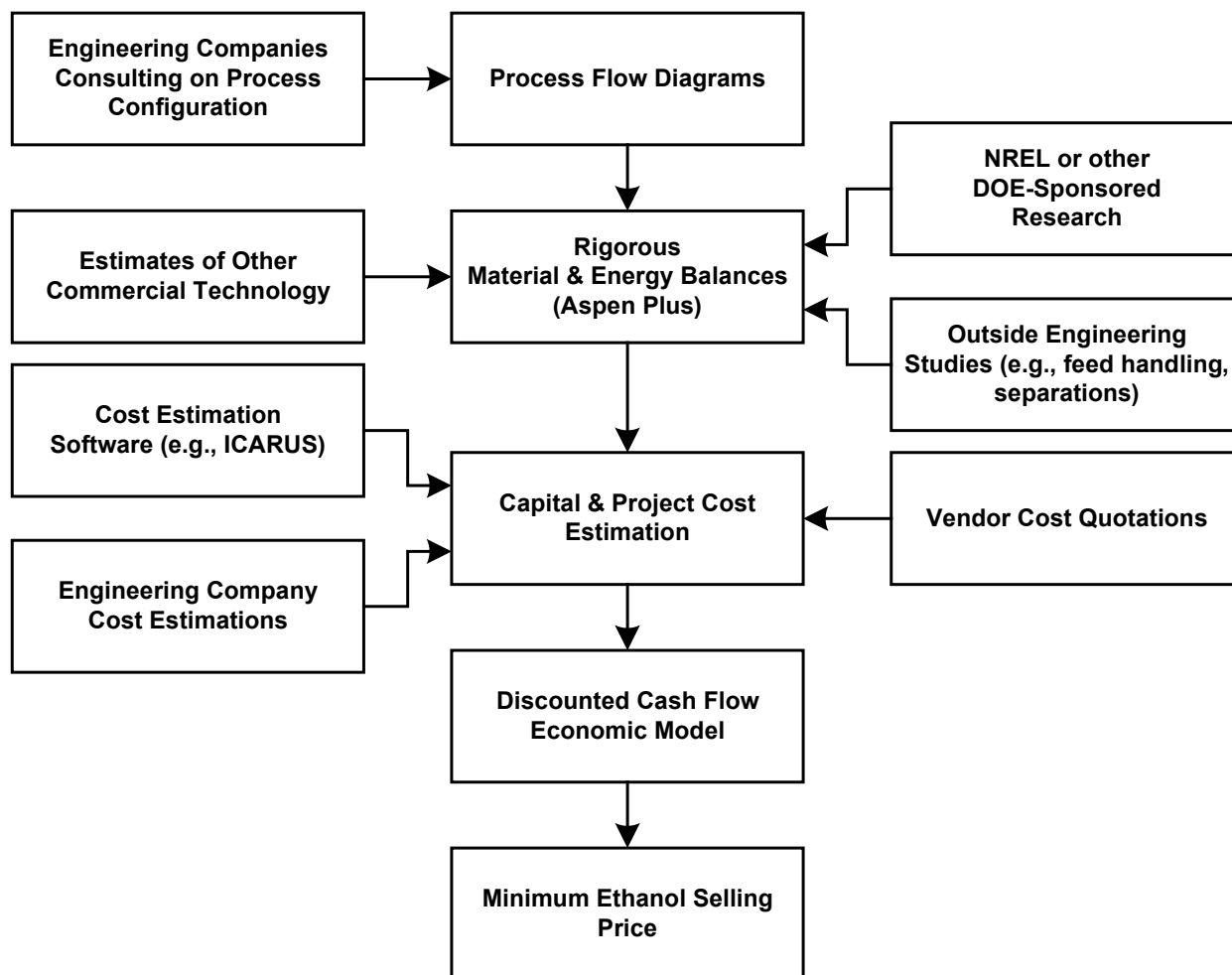

Figure 1. Simplified flow diagram of the overall process, PFD-P120-A000

### 1.3 Technoeconomic Analysis Approach

Figure 2 describes the engineering approach used here for modeling the conversion of biomass to ethanol, including process design, process modeling, and economic analysis.



**Figure 2. NREL's approach to process design and economic analysis**

Starting from the general process flow diagram (PFD) shown in Figure 1 and the more detailed PFDs contained in Appendix E, a process simulation is developed using Aspen Plus software [3]. This process model computes thermodynamically-rigorous material and energy balances for each unit operation in this conceptual biorefinery.

The material and energy balance data from the Aspen simulation are next used to assist in determining the number and size of capital equipment items. As process conditions and flows change, baseline equipment costs are automatically adjusted in an Excel spreadsheet using a scaling exponent. These baseline costs come from vendor quotes (favored for larger or non-standard unit operations and packaged or skid-mounted subsystems) or from Harris Group's

proprietary cost database (for secondary equipment such as tanks, pumps, and heat exchangers). Final equipment costs for this report are tabulated in Appendix A.

Once equipment costs are determined, direct and indirect overhead cost factors (e.g., installation costs and project contingency) are applied to determine a total capital investment (TCI). The TCI, along with the plant operating expenses (also developed using flow rates from the Aspen model), is used in a discounted cash flow rate of return (DCFROR) analysis to determine a plant-gate price for ethanol for a given discount rate. This plant-gate price is also called the minimum ethanol selling price (MESP, \$/gallon) required to obtain a net present value (NPV) of zero for a 10% internal rate of return (IRR) after taxes.

The product of the analysis described above is a technoeconomic model that reasonably estimates a product price for a pre-commercial process. The resultant MESP is unique for the set of process conditions simulated and it should be emphasized that a certain percentage of uncertainty always exists around these chosen conditions, as well as around the assumptions made for capital and raw material costs. Without a detailed understanding of the basis behind it, the absolute computed MESP has limited relevance. While the MESP can be used to assess the marketplace competitiveness of a given process, it is best suited for comparing technological variations against one another or for performing sensitivity analyses that indicate where economic or process performance improvements are needed.

#### **1.4 About $n^{\text{th}}$ -Plant Assumptions**

The technoeconomic analysis reported here uses what are known as “ $n^{\text{th}}$ -plant” economics. The key assumption implied by  $n^{\text{th}}$ -plant economics is that our analysis does not describe a pioneer plant; instead, several plants using the same technology have already been built and are operating. In other words, it reflects a mature future in which a successful industry of  $n$  plants has been established. Because the technoeconomic model is primarily a tool for studying new process technologies or integration schemes in order to comment on their comparative economic impact, we feel it is prudent to ignore artificial inflation of project costs associated with risk financing, longer start-ups, equipment overdesign, and other costs associated with first-of-a-kind or pioneer plants, lest these overshadow the real economic impact of research advances in conversion or process integration. At the very least, these  $n^{\text{th}}$ -plant economics should help to provide justification and support for early technology adopters and pioneer plants.

In previous design reports that targeted 2012 technology, many of the  $n^{\text{th}}$ -plant assumptions also applied to key 2012 research targets in conversion, e.g., 90% conversion of xylan to xylose, which in 2002 had not yet been experimentally demonstrated. This report will show that through research progress, current conversion performance is approaching the targets set in 2002 and that the 2012 performance targets should no longer be considered speculative. Assumptions in the previous model also extended to enzyme costs and some equipment costs, particularly those items that were not commercially available at the time (e.g., the pretreatment reactor). In the present design report, enzyme and equipment costs are considerably more well-defined.

The remaining  $n^{\text{th}}$ -plant assumptions in the present model therefore apply primarily to the factored cost model used to determine the total capital investment from the purchased equipment cost and to the choices made in plant financing. The  $n^{\text{th}}$ -plant assumption also applies to some operating parameters, such as process uptime of 96%. These assumptions were agreed upon by



NREL and DOE for this report and reflect our best estimates at the time of publication. It should be emphasized, however, that these assumptions carry a large uncertainty and are subject to refinement.

### 1.5 Review of Related Technoeconomic Studies

Tao and Aden [4] performed a survey of technoeconomic models of existing biofuels (corn ethanol, sugarcane ethanol, and conventional soy biodiesel) from the literature. These studies were normalized to a consistent year-dollar value and feedstock cost (where applicable) and compared to published market studies. This comparison, shown in Table 1, indicated that technoeconomic analysis was able to predict the actual cost of production of these biofuels within the expected accuracy of such models.

**Table 1. Comparison of Technoeconomic Analyses and Market Studies for Existing Biofuels**

Fuel	Market Study	TE Model
Corn ethanol	\$1.53/gal <sup>a</sup>	\$1.54/gal <sup>b</sup>
Sugarcane ethanol	\$1.14/gal <sup>a</sup>	\$1.29/gal <sup>c</sup>
Soy biodiesel	\$2.15/gal <sup>d</sup>	\$2.55/gal <sup>e</sup>

<sup>a</sup> F.O. Lichts, 2007 [5].

<sup>b</sup> Kwiatkowski et al., 2006 [6].

<sup>c</sup> Rodrigues, 2007 [7]; Seabra, 2007 [8].

<sup>d</sup> Graboski & McCormick, 1998 [9].

<sup>e</sup> Haas et al., 2006 [10].

The quantitative agreement in Table 1 is not altogether surprising, because the developers of these models were able to compare their results to real economics and make adjustments as necessary. (Also, for these particular fuels, feedstock makes up the largest part of the production cost, so uncertainty in the remaining non-feedstock conversion costs is not as obvious.) Developing a technoeconomic model for a pre-commercial technology, such as the corn-stover-to-ethanol process described in this report, requires a more *ab initio* approach, rooted in a thorough understanding of the state of the technology at the time of the analysis and good engineering practice.

In the years since the last NREL design report in 2002, several newer technoeconomic studies of biochemical cellulosic ethanol production have been published. Many of these studies were based to varying degrees on NREL’s previous design report, borrowing from its process assumptions, cost information, or both. This was in fact the principal goal of the earlier NREL design reports: to establish a baseline or “zero-point” technoeconomic benchmark from which process alternatives and improvements could be evaluated by others in the public realm. The present report now aims to establish a new zero-point and thereby serve a similar purpose for analyses going forward.

A brief survey of MESP values from recent technoeconomic studies of biochemical cellulosic ethanol production is presented in Table 2; note that these studies were not normalized to a consistent cost-year but were all published between 2008 and 2010, so cost-year differences should be minor. Clearly, there is a wide range of published MESP values within this subset of papers. For the most part, these are due to differences in feedstock cost, process assumptions, and co-product values, all of which vary considerably across the studies. For example, the analysis by Laser et al. [11] assumes a fairly low feedstock cost and very high yields (indicating aggressive process

assumptions) as well as improved economies of scale (if such a high feed rate can be sustained), while also receiving positive revenue from higher-value co-products such as protein and hydrogen. Furthermore, this study assumes a consolidated bioprocessing (CBP) approach, which—although less developed than separate saccharification and co-fermentation—could further improve economics by reducing enzyme costs. Conversely, studies on the high end of the MESP range such as Kazi et al. [12] and Klein-Marcuschamer et al. [13] assumed higher feedstock costs while achieving much lower ethanol yields. Compared to NREL’s 2002 design report (upon which many of its cost inputs were based), the Klein-Marcuschamer study’s base case assumes much longer batch times for saccharification and fermentation (thus higher associated capital costs), higher enzyme costs, and a lower carbohydrate fraction in the feedstock (contributing to lower yields) [14].

**Table 2. Survey of Recent Technoeconomic Studies on Biochemical Cellulosic Ethanol**

<b>Source</b>	<b>MESP (\$/gal)</b>	<b>Feedstock</b>	<b>Scale (dry ton/day)</b>	<b>Feed Price (\$/dry ton)</b>	<b>Ethanol Yield (gal/dry ton)</b>	<b>Notes</b>
NREL 2002 Design Report (2007\$) [2]	1.49	Corn stover	2,200	51	90	Dilute-acid pretreatment, SSCF process, electricity co-product
NREL 2011 Design Report (this work)	2.15	Corn stover	2,200	59	79	Dilute-acid pretreatment, SHF process, electricity co-product
Kazi [12]	3.40-4.44	Corn stover	2,200	75	42-72	Varying pretreatment options and downstream process assumptions
Huang [15]	1.42-1.87	Aspen, poplar, corn stover, switchgrass	2,200	58-100	83-111	Dilute-acid pretreatment
Sendich [16]	1.03-1.41	Corn stover	2,200	40	70	AFEX pretreatment, SSCF process, varying process conditions
Sendich [16]	0.80-0.95	Corn stover	2,200	40	78	AFEX pretreatment, CBP process, varying process conditions
Laser [11]	0.63-0.83	Switchgrass	5,000	44	97-105	AFEX pretreatment, CBP process, varying pathways and co-products
Gnansounou [17]	2.12-2.91	Straw, eucalyptus, poplar, switchgrass	1,760-2,200	57-127	70-84	Dilute-acid pretreatment
Bals [18]	1.86-2.20	Corn stover	850	45	78	AFEX pretreatment, varying pretreatment conditions
Piccolo [19]	3.43-4.03	Hardwood	2,200	65	75	Dilute-acid pretreatment, varying financial inputs
Klein-Marcuschamer [13]	3.53-4.58	Corn stover	1,700	60	52-74	Dilute-acid pretreatment, varying feed compositions and process conditions
National Academy of Sciences [20]	1.20-2.70 (COP)	Poplar and "high glucan"	1,000-1,600	50-88	67-106	Hot water pretreatment, Cost of Production analysis (COP<MESP)

To further demonstrate the impact of such assumptions, we turn to the study of Kazi et al. [12], a joint effort between Iowa State University, ConocoPhillips, and NREL. While this paper examined a variety of pretreatment and downstream processing alternatives, its baseline was essentially NREL’s 2008 State of Technology (SOT) model (dilute-acid pretreatment, purchased cellulase enzyme, and C5/C6 co-fermentation) [21]. The Kazi et al. study adjusted several key parameters from the 2008 SOT model to incorporate external public data. The feedstock cost, enzyme cost, indirect capital cost factors, and reaction conversions were all modified per data external to NREL analysis. While both analyses were intended to represent near-term or “state of technology” economics extrapolated to an  $n^{\text{th}}$  plant as discussed previously, the assumptions in the Kazi et al. study were generally more conservative than NREL’s 2008 SOT, raising the MESP considerably. Adjusting for these key economic assumptions, their MESP closely approaches that of the NREL 2008 SOT case, as shown in Figure 3. In many cases, economic variance between technoeconomic studies is easily explained by normalizing for a few important inputs.

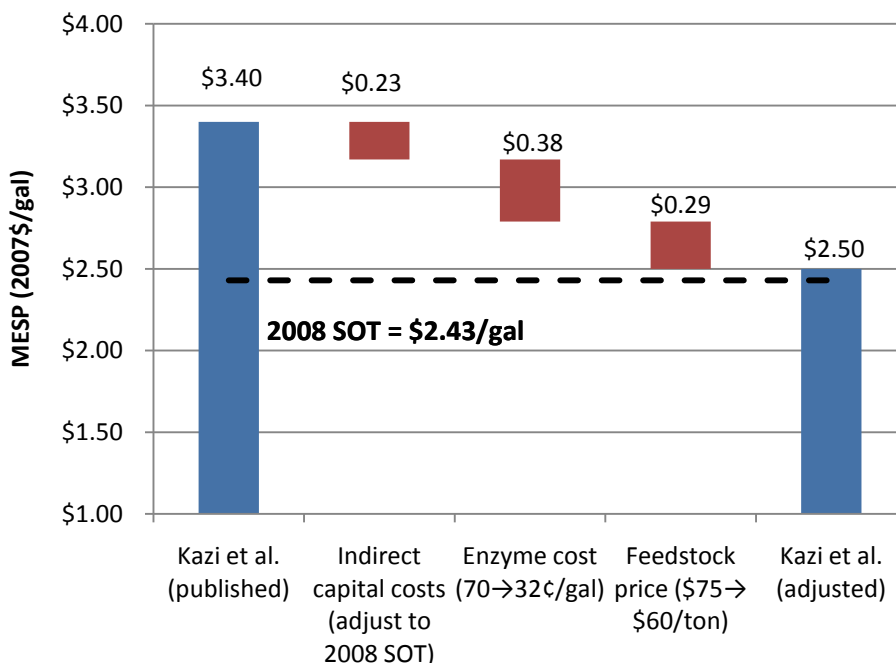

**Figure 3. Adjusting the Kazi et al. base case (\$3.40/gal) to NREL 2008 SOT assumptions**

### 1.6 About the NREL Aspen Model

The final version of the Aspen model used to generate this design report is named DW1102A; this version will be made publicly available along with this design report. We note that it is not uncommon to find subtle differences in Aspen results between software versions and patch levels. The results presented here were obtained with model DW1102A on Aspen Plus V7.2, patch level 0.

While Aspen can be completely rigorous, such detail is not always warranted in our simulation. Some unit operations, particularly solid-liquid separation, were modeled with a fixed

performance determined by vendor testing. Bioreactors were modeled using experimentally-determined conversions of specific reactions (e.g., cellulose to glucose) rather than using rigorous kinetics or rate expressions. This simple stoichiometric model still satisfies mass and energy balances.

The Aspen Plus simulation uses component physical properties internal to the software as well as property data developed at NREL or from the literature [22, 23]. Since the 2002 model was created, we have taken steps to reduce the number of custom-defined components and have eliminated the external property databanks. A discussion of the components and properties used is given in Appendix D.

## 2 Design Basis and Conventions

### 2.1 Plant Size

The plant size in the present design is the same as in the 2002 design: 2,205 dry U.S. ton/day (2,000 metric tonne/day). With an expected 8,410 operating hours per year (96% uptime), the annual feedstock requirement is 773,000 dry U.S. ton/year. The 2002 study assumed that an ethanol plant would be responsible for collecting and storing its own corn stover supply for the year, and 2,205 dry ton/day represented a 50-mile corn stover collection radius, assuming that 10% of the biomass within that radius was available to the plant.

In the present design, feedstock is assumed to be delivered to the plant from a satellite storage and processing facility like the pioneer uniform-format facility described by Idaho National Laboratory (INL) [24]. That facility is designed to supply 882,000 dry U.S. ton/yr of biomass; enough to supply one of the ethanol plants described here or multiple smaller facilities. We have not repeated the plant-size sensitivity study from the 2002 report, which indicated that only modest cost reductions due to economies of scale could be achieved beyond 2,205 ton/day. Although the absolute MESP is different in the present report, we expect that the plant-size trends observed in the 2002 report are still valid.

### 2.2 Feedstock Composition

The feedstock type and composition can have significant impacts on the overall process design and economics. Feedstock type may influence the design of key components in the conversion process, e.g., the pretreatment reactor. Feedstock composition, from a potential sugar perspective, clearly affects the ethanol yield. The feedstock used for this analysis was corn stover. Stover is a generic term that refers to the “rest” of the corn plant, i.e., everything above the ground that is not a kernel of corn: leaves, stalks, husks, cobs, etc. NREL biochemical conversion research has focused on corn stover primarily because it is the most abundant agriculture residue in the U.S. and is thus readily available. While dedicated energy crops like switchgrass may ultimately have sustainability and yield advantages over agricultural residues like corn stover, these crops are currently not available in the large volumes required for pilot-scale research.

Corn stover can vary in composition and moisture content due to corn variety, region, weather, soil type, fertilization practices, harvesting and storage practices, time in storage, and so on. A recent NREL study assessed the compositions of corn stovers from many commercial hybrid corn varieties using a rapid compositional analysis method known as near-infrared spectroscopy/projection-to-latent-structures modeling (NIR/PLS) [25]. This study evaluated the compositions of 508 commercial corn stover samples collected from 47 sites in eight Corn Belt states after the 2001, 2002, and 2003 harvests. From this study, the average concentrations (dry wt %) of the major stover components were 32% glucan, 19% xylan, 18% solubles, and 13% lignin (corrected for protein). These composition results are summarized in Table 3 along with the characteristic variation of each component. Figure 4 shows the distribution of total structural carbohydrate content among the samples.

**Table 3. Summary of Whole Stover Composition Data**

<b>Component</b>	<b>Average (dry wt %)</b>	<b>Min</b>	<b>Max</b>	<b>Range</b>
Ethanol solubles	3.3	1.7	4.1	2.4
Sucrose	3.6	0	10	10
Extractable inorganics (soil)	2.5	0	4.8	4.8
Other water extractables	8.6	1.4	15.7	14.2
<i>Total solubles</i>	<i>17.9</i>	<i>5.7</i>	<i>30.8</i>	<i>25</i>
Glucan	31.9	26.5	37.6	11
Xylan	18.9	14.8	22.7	7.9
Galactan	1.5	0.8	1.9	1.1
Arabinan	2.8	1.6	3.6	2
Mannan	0.3	0	0.7	0.7
Lignin (corrected for protein)	13.3	11.2	17.8	6.6
Structural inorganics	3.9	0.8	6.6	5.8
Protein	3.7	1.1	5.4	4.3
Acetyl	2.2	0.9	2.9	2
Estimated uronic acids	3.1	2.5	3.7	1.2
<i>Total structurals</i>	<i>81.6</i>	<i>70.4</i>	<i>90.8</i>	<i>20.4</i>
<b>Component closure</b>	<b>99.5</b>	<b>93.8</b>	<b>104.9</b>	<b>11.1</b>

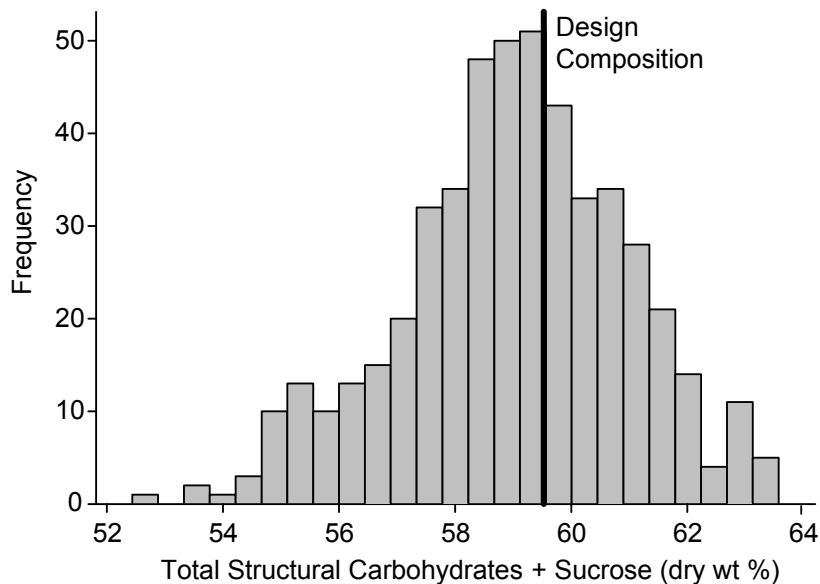

**Figure 4. Structural carbohydrate distribution of the feedstock variability study [25]**

Table 4 compares the composition used in the 2002 design to the composition used in the present design. The composition used in the 2002 design was based on an average of nine stover samples obtained from two batches [26]. Compared with the data in Table 3, its glucan, xylan, and lignin concentrations were each higher than the more recent study's averages for those components and near or above the maximum concentration measured in the 508 stover samples. (The earlier corn stover was handled extremely carefully between the field and the lab, while the samples from the more recent study were collected from the fields well after harvest.) The composition chosen for the present design was based on a single sample taken from the overall distribution. As indicated

in Figure 4, this composition fits well inside the carbohydrate distribution of the more recent study and therefore provides a more representative design basis. The moisture content value assumed for corn stover was also updated to 20% based on the feedstock logistics specifications table developed by INL and reported in the OBP Multi-Year Program Plan (MYPP) [27].

**Table 4. Corn Stover Composition from the 2002 Design [2] and the Present Design**

<b>Component</b>	<b>2002 Design (dry wt %)</b>	<b>Present Design (dry wt %)</b>
Glucan	37.40	35.05
Xylan	21.07	19.53
Lignin	17.99	15.76
Ash	5.23	4.93
Acetate <sup>a</sup>	2.93	1.81
Protein	3.10	3.10
Extractives	4.68	14.65
Arabinan	2.92	2.38
Galactan	1.94	1.43
Mannan	1.56	0.60
Sucrose	-	0.77
Unknown soluble solids <sup>b</sup>	1.18	-
<i>Total structural carbohydrate</i>	<i>64.89</i>	<i>58.99</i>
<i>Total structural carbohydrate + sucrose</i>	<i>64.89</i>	<i>59.76</i>
<i>Moisture (bulk wt %)</i>	<i>15.0</i>	<i>20.0</i>

<sup>a</sup> Represents acetate groups present in the hemicellulose polymer; converted to acetic acid in pretreatment.

<sup>b</sup> In the 2002 design, unknown soluble solids were calculated by difference to close the mass balance. This is now included in the extractives component.

When converting the analytical composition to components used in the Aspen model, the water- and ethanol-soluble fractions from the compositional analysis were combined under “extractives.” The extractives component is assumed to be organic, with an average composition of CH<sub>2</sub>O, and consists primarily of sugars, sugar alcohols, and organic acids [28]. The presence of extractives in corn stover depends on the time of harvest and in part to how much microbial degradation of the material occurs after harvest; the amount of extractives in a given sample may therefore be indicative of its age. Additionally, where the mass balance did not sum to 100%, the extractives component was used to close it by difference. (In the 2002 design, the “unknown soluble solids” component performed this function.) Sucrose is another extractive component, but it is measured separately in laboratory analysis and has been added as a feedstock component in the present design; it is therefore excluded from the extractives component. The amount of sucrose present in corn stover is highly dependent on harvesting and handling practices. In pretreatment, this sucrose is assumed to be fully hydrolyzed to glucose and fructose. The fructose is further converted to degradation products in pretreatment, but the glucose resists degradation and thus is available for fermentation [29].

The differences in composition between the 2002 design and the present design have a few notable economic implications. Because the glucan (cellulose) content in the feedstock is lower, the present design has a lower ethanol yield per ton of feedstock. On the whole, the total structural carbohydrate composition (glucan + hemicellulose components) is about 5% lower than in the 2002 composition. Conversely, in the present design, a larger portion of the feedstock is non-carbohydrate organic compounds. These ultimately become process residues that are



burned to provide heat and electricity. The amount of electricity generated per ton of feedstock processed is therefore higher than in the 2002 design (though less electricity is exported as a co-product because the present design has a higher internal electricity demand).

## **2.3 Design Report Conventions**

### **2.3.1 Units**

The Aspen model we developed is, by legacy, based on the set of units required by Aspen for specifying custom component properties: kg, kmol, atm, °C for materials, and MMkcal (Gcal) for energies. Values in this report that were pulled directly from the Aspen model therefore tend to be reported in these units. Harris Group preferred to use U.S. standards (lb, Btu, °F, gal, etc.) when communicating with equipment vendors. Therefore, equipment specifications tend to be cited in these U.S. units. We have made an effort to cite both sets of units in this report, to the degree that it does not distract from the discussion.

Note that in the present report, certain quantities (e.g., yields and costs) are computed and reported in terms of “tons.” To avoid ambiguity, **tonne** will denote a metric tonne (1,000 kg) and **ton** will denote a short or U.S. ton (2,000 lb). In general, the U.S. ton is the standard for this document. “Ton” also appears in Section 3.9 in the context of refrigeration, but this usage should be clear from the discussion.

### **2.3.2 Total Solids Loading**

The process described here converts a solid feedstock (corn stover) into a liquid product (ethanol). Most material streams in the process therefore have a solid fraction and a liquid fraction. The relative amount of solids in a given stream is called its “solids loading.” Total solids loading is defined as the total weight percent of soluble solids (e.g., sugars and salts) and insoluble solids (e.g., cellulose and lignin) in a given material stream. Where useful, the total solids loading and the insoluble solids loading will be reported together. Note that in our convention, sulfuric acid, acetic acid, and ammonia are not considered soluble solids but ammonium acetate and ammonium sulfate are. Therefore, around some unit operations, e.g., hydrolysate conditioning, total solids loading is not a conserved quantity.

### **2.3.3 Ethanol Density**

The most important results from this analysis are reported in terms of volume of ethanol produced: \$/gal, gal/yr, gal/ton, etc. To avoid errors in these quantities that may arise from using the ethanol density computed by Aspen Plus, an accepted value was used for anhydrous ethanol at 20°C (68°F): 0.789 kg/L [30].

### **2.3.4 Theoretical Yields and Conversions**

The terms “yield” and “conversion” are used throughout this report to describe the extent of various chemical and biochemical reactions. It should be understood that each of these quantities is a percentage of the theoretical. For example, the statement “95% conversion of glucose to ethanol” means that 95% of the glucose in the system was consumed in the following reaction:



which has a theoretical yield of 0.51 g ethanol / g glucose.

### 3 Process Design and Cost Estimation Details

The process design described in this study was based upon demonstrated performance and planned performance goals from DOE’s core R&D efforts in biochemical conversion. This section describes the process in detail and discusses the influence of specific R&D goals in the decision-making process.

#### 3.1 Area 100: Feedstock Storage and Handling

##### 3.1.1 Overview

Area 100 handles incoming biomass feedstock. In contrast to the 2002 design, which assumed bale delivery and yard storage of corn stover followed by milling and washing, the present design assumes that corn stover is delivered according to the specifications detailed in the Idaho National Laboratory (INL) design report for the pioneer uniform-format feedstock supply system [24]. In this envisioned design, biomass is stored in a central depot and is preprocessed and homogenized to a degree before delivery, such that the biorefinery receives feedstock with known, uniform-format specifications including particle size distribution, moisture content, and bulk density.

Harris Group designed the receiving and handling system in Area 100 based on this delivery specification, using the INL design report as well as its own experience with the required equipment. The equipment in Area 100 is physically located at the ethanol plant and consists of weighing and unloading stations for incoming biomass supply trucks, short-term queuing storage, and conveyors for feeding bulk feedstock to the pretreatment reactor. A simplified process flow diagram for this area is shown in Figure 5, and more detail is given in PFD-P120-A101 (Appendix E).

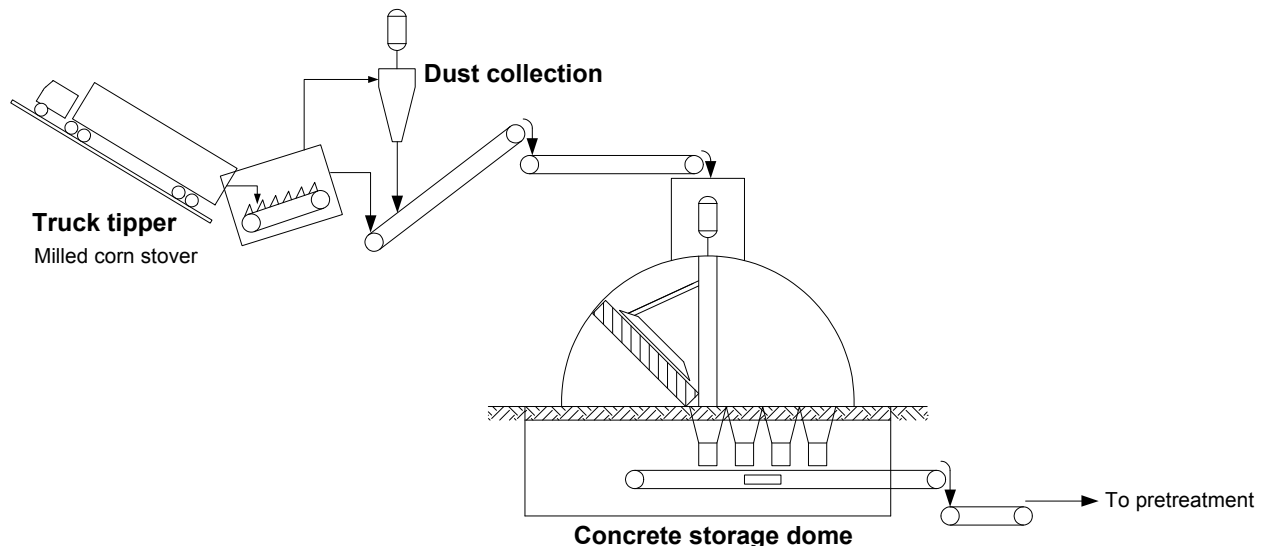

Figure 5. Simplified flow diagram of the feedstock receiving system

### **3.1.2 Design Basis**

In the uniform-format feedstock supply system design, feedstock would be stored in a satellite depot location with delivery to the biorefinery occurring six days a week by truck or possibly by rail. At the depot, material would be milled to a mean size of 0.16–0.23 in. (with a high content of fines), in order to achieve a mean bulk density of 9–11 lb/ft<sup>3</sup> to maximize the biomass load per trailer. The incoming corn stover feedstock is assumed to have 20% moisture when it reaches the biorefinery; this is representative of a mixture of field-dried material having <15% moisture and co-harvested material having >20% moisture. Because the preprocessing operation is designed to lose very little dry matter and does not include any rinsing of biomass, it is assumed that the corn stover composition discussed in Section 2.2 is valid for the delivered material. We also note that the particle size of <0.25 in. is consistent with the material currently used in NREL pretreatment research.

The as-received corn stover feed requirement for the plant is 2,756 U.S. ton/day (104,200 kg/h; 229,700 lb/h) including moisture. In the projected design, refinery receiving operates on the same schedule as the biomass depot: 24 hours a day, six days a week. Each truck trailer holds 10 U.S. tons of biomass. To satisfy production and storage requirements, the plant must receive 12 trucks every hour. Incoming trucks are weighed by electronic scale (M-101) and unloaded using a whole-truck dumper (M-102) capable of a 7–10 minute unloading time. The dumpers empty into dedicated hoppers (M-103), which meter the biomass to a series of conveyors (C-101, C-102, C-103). These carry material from the truck tipper to short-term storage. The minimum receiving rate is 244 ton/h to maintain 114 ton/h of continuous processing. Because trucks are not unloaded continuously, some extra capacity needs to be built into the conveyor that carries material from the truck dumpers to storage (minimum 330–440 ton/h recommended). In order to process 244 ton/h, and assuming a relatively constant flow of trucks, a pair of scales (one inbound and one outbound) and two truck dumpers are required.

On-site storage is kept to a minimum of 72 hours to allow for a weekend buffer. Open piles are not favored due to concerns of fire, rodent infestation, and moisture degradation. Instead, the unloaded feedstock is stored in concrete domes (M-104). Two domes (each with a 36-hour capacity) are required so that one can be loaded while the other empties to the conversion process.

Conveyors (C-106, C-107, C-108) connect the storage domes to the feedstock receiving bins on the pretreatment reactor in Area 200. A dust collection system (M-106) integrated with the conveyors and domes handles airborne particles released during the unloading and conveying processes. No dry matter is assumed lost in Area 100. In contrast to the 2002 design, the feedstock is not washed, which eliminates a source of evaporative water loss in this area. There is some evidence that feedstock washing may still be desired to reduce any incoming inorganics from fertilized feedstocks like corn stover, and this practice may be revisited in the future.

### **3.1.3 Cost Estimation**

The feedstock cost assumed in this report is \$58.50/dry ton (2007\$). This cost comes from the Multi-Year Program Plan (MYPP) published by DOE's Office of the Biomass Program [27]. The total of \$58.50/ton includes \$23.50/ton for a grower payment (MYPP Table B-1) and \$35/ton for all collection, processing, storage, and transportation costs between the field and the receiving

bin on the pretreatment reactor (MYPP Table B-2). It should be stressed that these costs are 2012 DOE research targets, like the conversion performance targets used in the Aspen model.

Harris Group did obtain vendor quotes or other estimates for the truck unloading equipment, storage domes, conveyors, and dust collectors. Although the final equipment list assembled by Harris Group does not completely match the INL design report, the capital and operating costs for Area 100 are assumed to be included in the MYPP feedstock cost and are not included in the total capital investment (TCI) calculation; therefore they do not affect the MESP.

The truck scales were quoted by St. Louis Scale, and the truck dumpers and hoppers were quoted by Jeffrey Rader. The storage domes, each with a 4,400 ton capacity, were quoted by Domtec. The internal reclaim system was quoted by Cambelt. All other connecting conveyors were quoted by Dearborn Midwest Conveyor Co. Sly, Inc. provided a quote for all components in the dust collection system. The belt scales for biomass leaving the storage domes were quoted by Tecweigh.

## 3.2 Area 200: Pretreatment and Conditioning

### 3.2.1 Overview

The pretreatment process converts most of the hemicellulose carbohydrates in the feedstock to soluble sugars (xylose, mannose, arabinose, and glucose) by hydrolysis reactions. Acetyl groups in the hemicellulose are liberated as acetic acid. The breakdown of biomass in pretreatment facilitates downstream enzymatic hydrolysis by disrupting cell wall structures, driving some lignin into solution, and reducing cellulose crystallinity and chain length. The nature and extent of such changes are highly dependent on the pretreatment chemistry and reaction severity (defined by residence time, temperature, and catalyst loading). Sugar degradation products such as furfural and 5-hydroxymethyl furfural (HMF) can also be formed in pretreatment. These compounds can have adverse effects on the fermenting organisms in sufficiently high concentrations.

In the present design, hydrolysis reactions are catalyzed using dilute sulfuric acid and heat from steam. Pretreatment is carried out in two stages in the present design and the reaction severity is fairly mild compared to what has been modeled in the past. This milder pretreatment favors the production of soluble xylose oligomers. Higher-severity pretreatments tend to produce more monomeric xylose but at the risk of forming significant amounts of degradation products if reaction conditions are not well controlled.

The first stage in pretreatment is a horizontal screw-feed reactor with a short residence time (5–10 minutes). The second stage is a lower temperature/longer residence time “oligomer conversion” step that converts most of the xylose oligomers leaving the first stage to monomeric xylose without generating significant additional degradation products [31]. After the pretreatment reactors, the hydrolysate slurry is flash-cooled, vaporizing a large amount of water along with some of the acetic acid and furfural. The flash vapor is condensed and sent to the wastewater treatment area. The hydrolysate slurry is cooled by dilution water and sent to a conditioning reactor, where ammonia is used to raise its pH from 1 to 5–6. Figure 6 shows a simplified flow diagram of the pretreatment area.

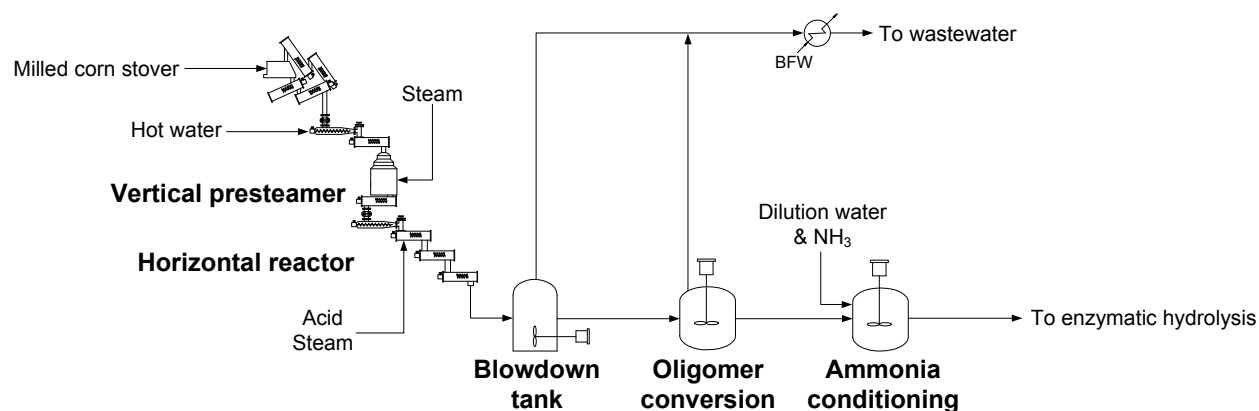

Figure 6. Simplified flow diagram of the pretreatment and conditioning process

In previous designs, the pretreated biomass was separated into washed solid and liquid fractions, and the liquor and wash water were conditioned by an “overliming” process in which the pH was increased from 1 to ~10 with lime and then readjusted to ~5 with additional sulfuric acid. The lime and sulfuric acid precipitated as gypsum, which was removed in another solid-liquid separation step. The conditioned liquid was then re-slurried with the cellulosic solids before enzymatic hydrolysis. In overliming, a significant amount of sugar in the liquor (as much as 13%) could be lost to side reactions occurring at high pH or pressed out with the wet gypsum. The present design uses ammonia in place of lime to avoid these sugar losses. The high miscibility of ammonia also permits conditioning of the whole hydrolysate slurry and eliminates the solid-liquid separation steps. Fermentation studies have indicated that there is no benefit to over-conditioning at high pH when using ammonia, so the hydrolysate is simply adjusted to enzymatic hydrolysis pH in one step. While ammonia is considerably more expensive than lime, the economic benefits of reduced sugar loss and reduced capital cost make ammonia the more economic alternative [32]. It is also possible that the ammonia could reduce nitrogen requirements in fermentation, but this currently is not modeled.

### **3.2.2 Design Basis**

The pretreatment reactor system includes a feedstock receiving system, followed by a vertical vessel with a long residence time for steam-heating and potential acid impregnation of the biomass, followed by the horizontal pretreatment reactor, which operates at a higher pressure and a short residence time. PFD-P120-A201 (Appendix E) shows the components in greater detail and PFD-P120-A202 shows the oligomer conversion and conditioning equipment. The horizontal reactor configuration was chosen because it permits tighter residence time distribution control than a vertical reactor. This is important in single-step, high-severity pretreatment to minimize “over-cooking” or “under-cooking” portions of the biomass, either of which would lower the overall yield.

Milled corn stover is fed to the receiving bins at the inlet of the pretreatment reactor (M-201). The receiving bins are rectangular with a bottom-drag conveyor that moves the feedstock pile inside the bin toward the doffing rolls (special scraper shafts with radial pins that spread material uniformly onto the discharge belt conveyor). The receiving bins also have a top rake-belt installed just under the bin cover to move incoming material toward the end of the bin, ensuring first-in/first-out material handling. At the discharge of each bin, the transfer conveyor (C-201) lifts material to the distribution screw conveyor (C-202), which supplies slightly (~10%) more feedstock than each pin drum feeder requires. Overfeeding allows the speed of the pin drum feeders to control the flow rate of material into each plug screw feeder. It also ensures that the plug screw feeders maintain a maximum fill. The excess feedstock is conveyed back to the storage bin by a series of screw conveyors (C-203).

Each pin drum feeder (M-202) packs feedstock material into separate plug screw feeders (M-203). The 26-in. plug screw feeder is a rugged, high-compression screw device designed to form a pressure-tight plug of material through axial compression. The compression action in each plug screw feeder may also squeeze out water and some of the water-soluble extractive components. This “pressate” could be handled as a separate, concentrated waste stream but in the present model, it is assumed that the pressate is recombined with the hydrolysate at the outlet of the reactor. Dilute sulfuric acid is injected at the discharge spool of the plug screw feeder. Feedstock drops from the plug screw discharge into a mixing and heating screw (C-204). The heating screw

discharges the feedstock into the top of the presteamer (M-204). Hot water is added at this point to control the pretreatment effluent at 30 wt % total solids.

The vertical biomass presteamer is designed for a retention time of up to 10 minutes at a temperature of up to 165°C, though in the current model it only operates at 100°C such that no significant hydrolysis reactions occur in the presteamer. With a 2,205 ton/day throughput and 10-minute retention time, a single vertical vessel is adequate. Feedstock flows downward through the vertical reactor with uniform temperature throughout. The reactor is discharged through a dual screw outlet device (C-205) to two plug screw feeders (M-206). The plug screw feeders meter feedstock to the pretreatment reactor and control the pressure and temperature difference between it and the presteamer. Acid for the pretreatment reaction is added at the discharge of each plug screw feeder. The transport conveyors (C-206, C-207) combine feedstock from both plug screw feeders and deliver it to the pretreatment reactor (M-207).

The pretreatment reactor is a single horizontal reaction vessel. The reactor is designed for fairly severe conditions of up to 190°C (374°F) and about 1.1 wt % sulfuric acid. In the current design, the reaction conditions are milder at 158°C (316°F) and 18 mg acid/dry g of biomass. Acid is metered to the reaction chamber at a rate proportional to the mass flow rate of feedstock. High-pressure steam is injected into this vessel to maintain temperature. The reactor pressure is held just at the bubble point for the mixture. Heat losses from the reactor are not accounted for in the energy balance calculations. The residence time in the pretreatment reactor is nominally 5 minutes. The reaction conditions are summarized in Table 5.

**Table 5. Pretreatment Reactor Conditions**

Sulfuric acid loading	18 mg/g dry biomass <sup>a</sup>
Residence time	5 minutes
Temperature	158°C
Pressure	5.5 atm (81 psia)
Total solids loading	30 wt %

<sup>a</sup> Additional acid is added downstream of the pretreatment reactor.

The pretreatment reactor is discharged to a flash tank (T-203). The pressure of the flash is controlled to keep the temperature at 130°C (266°F). The slurry from T-203 goes into the secondary oligomer conversion reaction vessel (T-208), where it is held at 130°C for 20–30 minutes. An additional 4.1 mg/g of sulfuric acid is added in the oligomer conversion step, bringing the total acid loading to 22.1 mg/g dry biomass. (Note that in the Aspen model, all of the acid is added to the pretreatment reactor block.)

The oligomer conversion reactor is discharged into another flash tank (T-204) that operates at atmospheric pressure. After this flash, the hydrolysate whole slurry containing 30 wt % total solids and 16.6 wt % insoluble solids is sent to the conditioning tank (T-209). Here, the slurry is diluted with water to slightly greater than 20 wt % total solids to ensure miscibility through enzymatic hydrolysis. Ammonia gas is mixed into the dilution water to raise the hydrolysate pH to 5. The residence time in T-209 is 30 minutes and the dilution cools the slurry to 75°C (167°F).

The flash vapor from T-203 is used to preheat the boiler feed water in H-812 or combined with the 100°C (212°F) flash vapor from T-204, which is condensed in H-201 and H-244. This

condensate contains volatile, potentially inhibitory organics created in pretreatment and therefore is routed to wastewater treatment (Area 600).

Table 6 summarizes the reactions and percent conversions that take place in pretreatment. Glucan contained in the hemicellulose side-chains is converted to glucose along with a small portion of the cellulose. Minor hemicellulose carbohydrates (arabinan, mannan, galactan) are assumed to have the same reactions and conversions as xylan. The xylan-to-xylose conversion is an assumed total hydrolysis that also includes an enzymatic component that will be discussed later. The sucrose reaction to HMF and glucose reflects 100% hydrolysis of sucrose to fructose and glucose, followed by complete degradation of the fructose to HMF, as mentioned in Section 2.2.

**Table 6. Pretreatment Hydrolysis Reactions and Assumed Conversions**

Reaction	Reactant	% Converted to Product
$(\text{Glucan})_n + n \text{ H}_2\text{O} \rightarrow n \text{ Glucose}$	Glucan	9.9%
$(\text{Glucan})_n + n \text{ H}_2\text{O} \rightarrow n \text{ Glucose Oligomer}^a$	Glucan	0.3%
$(\text{Glucan})_n \rightarrow n \text{ HMF} + 2n \text{ H}_2\text{O}$	Glucan	0.3%
$\text{Sucrose} \rightarrow \text{HMF} + \text{Glucose} + 2 \text{ H}_2\text{O}$	Sucrose	100%
$(\text{Xylan})_n + n \text{ H}_2\text{O} \rightarrow n \text{ Xylose}$	Xylan	90.0%
$(\text{Xylan})_n + m \text{ H}_2\text{O} \rightarrow m \text{ Xylose Oligomer}^a$	Xylan	2.4%
$(\text{Xylan})_n \rightarrow n \text{ Furfural} + 2n \text{ H}_2\text{O}$	Xylan	5.0%
$\text{Acetate} \rightarrow \text{Acetic Acid}$	Acetate	100%
$(\text{Lignin})_n \rightarrow n \text{ Soluble Lignin}$	Lignin	5.0%

<sup>a</sup> Sugar oligomers are considered soluble but not fermentable.

### 3.2.3 Cost Estimation

For the pretreatment reactor system, Harris Group obtained a detailed quote from Andritz, Inc., totaling approximately \$20MM for the whole system: feedstock receiving bin, additional size reduction steps (if necessary), pre-steaming, pressurized heating, reaction, and flash cooling. A reactor schematic provided by Andritz is shown in Figure 7. This reactor configuration is similar in principle to the pretreatment reactor assumed in the 2002 design.

The reactor system is constructed of carbon steel with all parts in contact with acid (pretreatment reactor, pressurized transporter, and plug screw feeder) clad in Incoloy 825. This met Andritz's approval but was primarily chosen to be consistent with the 2002 design and a previous NREL corrosion study on reactor metallurgy [33]. This reactor system is actually overdesigned for the pretreatment process conditions considered here and is capable of operating at a significantly higher severity. In the present design, the pretreatment system contributes about \$0.14/gal to the MESP; we chose not to adjust the cost of the reactor to account for the lower residence time, temperature, pressure, or acid loading. This will permit continued use of the same reactor cost in our analyses as researchers change the pretreatment severity in their optimization studies. As long as acid is used in any concentration, we believe it is unlikely that the reactor cost would change significantly because Incoloy (or similarly expensive) cladding would still be required. The reactor cost will be revisited in the future if pretreatment conditions change more significantly.



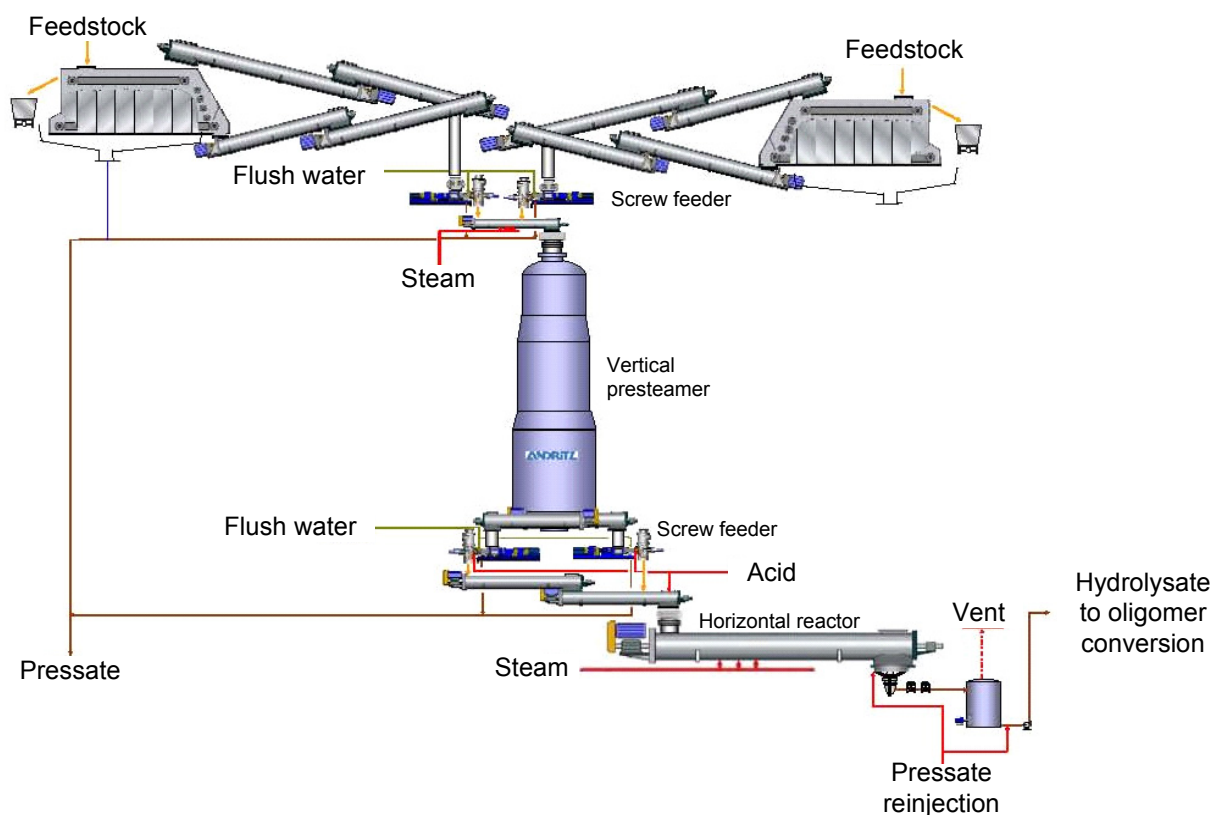

**Figure 7. Horizontal pretreatment reactor design scheme (Andritz, Inc.)**

Costs for other equipment, such as pumps, agitators, tanks, conveyors, and heat exchangers, were estimated using Harris Group’s internal database. The holding tank for sulfuric acid (T-201) is plastic, and the rest of the equipment is stainless steel—most of it 316SS to provide additional acid resistance at temperatures below 100°C (212°F).

### **3.2.4 Achieving the Design Case**

Table 7 shows demonstrated pilot-scale performance results achieved from 2008–2010 [21, 34–35] as well as the 2012 conversion targets (i.e., those used in the Aspen model) for the pretreatment area. In pretreatment, the 2012 target is 90% conversion of xylan to monomeric xylose with 5% loss to degradation products. An additional 2012 target is to move to a whole-slurry conditioning process and thereby eliminate the need for a solid-liquid separation step in the pretreatment area.

**Table 7. Research Status and 2012 Targets in the Pretreatment Area**

	<b>2008 State of Technology</b>	<b>2009 State of Technology</b>	<b>2010 State of Technology</b>	<b>2012 Targets</b>
<b>Pretreatment</b>				
Solids loading (wt %)	30%	30%	30%	30%
Xylan conversion to xylose (%)	75%	84%	85%	90%
Xylan conversion to furfural (%)	11%	6.4%	8%	5%
<b>Conditioning</b>				
Ammonia loading (g/L of hydrolysate)	13	10	4.8	4.8
Hydrolysate solid-liquid separation	yes	yes	yes	no
Xylose sugar loss (% entering conditioning)	2%	2%	2%	1%
Glucose sugar loss (% entering conditioning)	1%	1%	1%	0%

In NREL's pretreatment research, significant improvements in the conversion of xylan to xylose by dilute-acid pretreatment were demonstrated at the bench scale in 2007, where conversions of 75% or higher were routinely achieved in bench-scale batch reactors [36]. Efforts to duplicate these results in continuous pilot-scale operation in 2008 proved more challenging. Continuous pretreatment is more difficult than batch pretreatment because process conditions (residence time in particular) cannot be as tightly controlled. Experiments in NREL's 200 kg/day continuous horizontal pretreatment reactor indicated a xylan-to-xylose conversion limit of ~60% in that reactor configuration, though total conversion to monomeric and oligomeric xylose was around 75%. The mild secondary oligomer conversion step was therefore added to convert the oligomers to monomeric xylose without generating additional degradation products, meeting the 2008 xylose target of 75%.

In 2009, the internals of the horizontal reactor were modified to tighten its residence time distribution [37]. Optimization of the operating conditions between the two stages met 2009 targets with an overall xylan-to-xylose conversion of 79.6% with 6.4% loss to furfural. Remaining oligomers were 9.0%, leaving 5% of the xylan unreacted [38]. Further process optimization in 2010 showed little improvement over these conversions but additional xylose yield was obtained in enzymatic hydrolysis using an advanced cellulase preparation that has xylanase and "xylooligomerase" activities. In washed-solids enzymatic hydrolysis, the advanced enzyme preparation converted an additional 82% of the unreacted xylan to xylose. Overall, an 85.3% yield of monomeric xylose was achieved from all thermochemical and enzymatic processes in 2010 experiments [39].

The targeted enzymatic conversion of xylan and xylose oligomers described above is quite promising [40]. It could eliminate the secondary oligomer conversion step used in our design and, in general, permit lower-severity pretreatments that yield more xylose oligomers and fewer degradation products. Lower-severity pretreatments have relaxed residence time control requirements and may be able to utilize lower-cost vertical reactor configurations. (Vertical pretreatment reactors are typically less expensive than horizontal reactors with the same throughput because they have less complex internals, though reduced severity will probably not eliminate the need for exotic reactor cladding on acid-wetted surfaces.) Additionally, lower pretreatment severity would result in lower energy requirements and reduced chemical costs, including reduced cleanup in wastewater treatment.

Including these hemicellulase “accessory” enzymes in our technoeconomic analysis is complicated because little to no cost information exists for these highly specialized, pre-commercial enzymes. However, preliminary analysis has shown that if the xylan and xylose oligomer hydrolysis is carried out simultaneously with the cellulose enzymatic hydrolysis, accessory enzymes are probably the more economic option, assuming they can be obtained at a cost per kg of protein similar to that currently assumed for cellulase [41].

Replacing overliming with ammonia conditioning has eliminated significant sugar losses and gypsum disposal cost. Because ammonia can be mixed with the dilution water and applied as an aqueous solution, the whole hydrolysate slurry may be treated at once without a solid-liquid separation step. However, from Table 7, one may note that elimination of hydrolysate solid-liquid separation is not assumed until 2012. This is due not to problems with the conditioning procedure but to conversion limitations in whole-slurry enzymatic hydrolysis caused by end-product inhibition, particularly with respect to the xylanase activities discussed above. Nevertheless, in the present design, which is intended to reflect 2012 technology, a whole-slurry process through conditioning and enzymatic hydrolysis is assumed.

Further research topics in the pretreatment area include biomass deacetylation through acid pre-impregnation, use of co-catalysts (e.g., iron salts), and disc-refining of the pretreated slurry. These are designed to reduce sulfuric acid usage in pretreatment and achieve high xylose yields under less severe pretreatment conditions while maintaining high enzymatic digestibility of cellulose in the pretreated solids, with economic benefits as discussed above. In addition, deacetylation and disc-refining may significantly enhance downstream enzymatic hydrolysis and potentially decrease enzyme loading requirements. Acid pre-impregnation is not explicitly modeled in our design, but it is envisioned that it could take place in the vertical presteamer, though the cost of the reactor system would have to be increased to include Incoloy cladding on the presteamer as well as all screw feeders and conveyors between the presteamer and the pretreatment reactor. This design effort is ongoing.

### 3.3 Area 300: Enzymatic Hydrolysis and Fermentation

#### 3.3.1 Overview

In this process area, cellulose is converted to glucose using cellulase enzymes. This process is known as enzymatic saccharification or enzymatic hydrolysis. A cellulase enzyme preparation is a mixture of enzymes (catalytic proteins) that work together to break down cellulose fibers into cellobiose and soluble gluco-oligomers and ultimately into glucose monomers. The resulting glucose and other sugars hydrolyzed from hemicellulose during pretreatment are fermented to ethanol. Most fermentation research at NREL has used the recombinant co-fermenting bacterium *Zymomonas mobilis* because this microorganism and much of its genome are in the public domain [42]. “Co-fermenting” means that the organism can simultaneously ferment glucose and xylose to ethanol. Other co-fermenting ethanologens are also being considered at NREL and elsewhere, e.g., metabolically engineered strains of *Saccharomyces cerevisiae* [43].

The process assumed in this design is known as separate (or sequential) hydrolysis and fermentation (SHF). Enzymatic hydrolysis is initiated while the slurry is still at an elevated temperature after pretreatment and conditioning. At this temperature, the enzyme activity is higher so conversion is faster and a smaller amount of enzyme is required. Once the conversion of cellulose to glucose is complete, the slurry is cooled to fermentation temperature and inoculated with the fermenting microorganism (the “ethanologen”). This deviates from the 2002 process, which was based on a simultaneous saccharification and co-fermentation (SSCF) process in which the temperature of the slurry was reduced and fermentation was initiated before enzymatic hydrolysis was complete. In SSCF, the enzyme continues to hydrolyze cellulose even after fermentation is initiated. Fermentation creates a sugar sink (because sugar is being consumed by the ethanologen) that helps drive the enzymatic hydrolysis reactions toward glucose.

The 2002 process was also nominally continuous with a total residence time of 3 days. Based on more recent experience with *Z. mobilis*, a 5-day SHF process with batch fermentation was selected as a more realistic case for the present design. Enzymatic hydrolysis begins in a continuous, high-solids reactor. As the cellulosic solids are saccharified by the enzyme, the viscosity of the mixture drops dramatically, such that it can be pumped to one of several parallel bioreactors. Hydrolysis continues in this vessel until complete, then the slurry is cooled and the ethanologen inoculum is added. The ethanol-containing fermentation broth is emptied to the beer well (storage tank) before being pumped to distillation. Figure 8 shows a simplified flow diagram of the enzymatic hydrolysis and fermentation process.

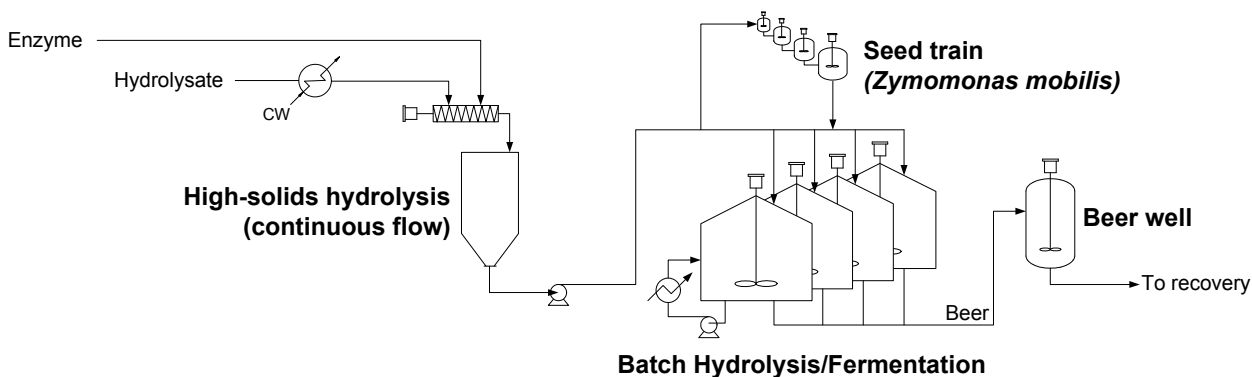

**Figure 8. Simplified flow diagram of the enzymatic hydrolysis and fermentation process**

### 3.3.2 Design Basis

The full process flow is shown in PFD-P120-A301 and -A302 (Appendix E). Enzymatic hydrolysis is initiated in a continuous, high-solids reactor (T-310). Neutralized, diluted hydrolysate is cooled with cooling water in H-301 and fed to T-310 at slightly higher than 20 wt % total solids. A 100-hp inline mixer upstream of the continuous hydrolysis reactor (A-308) mixes the enzyme into the slurry. After the cellulase enzyme stream is mixed in, the total solids loading is 20 wt % (10.6 wt % insoluble) and the temperature is 48°C (118°F). The residence time in this first stage is 24 hours, after which the slurry is batched to one of twelve 950,000-gal vessels (F-300), where enzymatic hydrolysis continues for another 60 hours.

Moving pretreated material at 20% (or higher) total solids loading is challenging because this material is not pumpable until the cellulose has been partially enzymatically hydrolyzed. In the present design, the continuous high-solids hydrolysis reactor is envisioned as an empty tower, with the slurry entering at the top and flowing down with gravity. Horizontal mixers with rotating paddles are another design option for performing the initial enzymatic hydrolysis reaction, and NREL will be testing such a reactor in its new Integrated Biorefinery Research Facility (IBRF) in 2011 [44]. These are expected to be more expensive than the plug-flow tower specified here, but not dramatically so given the relatively short residence time expected in the high-solids vessels and when considered in the total equipment scope of the plant. We believe that the tower design is a suitable placeholder.

The amount of enzyme used (the enzyme loading) is determined by the amount of cellulose present in the hydrolysate and the specific activity of the enzyme. In the present design, the total cellulase loading is 20 mg enzyme protein/g cellulose to achieve a 90% conversion to glucose. “Protein” here refers to the total concentration of protein in the enzyme broth as determined by assay; not all of this protein has cellulase activity. Although sugar yield generally increases with higher enzyme loading, the additional enzyme obviously comes at a cost. Enzyme loading therefore has a significant and complex impact on process economics. Determining the most economical enzyme loading requires optimization of several process parameters including temperature, residence time, and total solids loading [45]. The design conditions developed based on the recommendations of enzyme manufacturers and NREL researchers are summarized in Table 8.

**Table 8. Enzymatic Hydrolysis Conditions**

Temperature	48°C (118°F)
Initial solids loading	20 wt % total solids (10.6% insoluble/9.4% soluble)
Residence time	3.5 days total (84 h)
Number and size of continuous vessels	8 @ 950 m <sup>3</sup> (250,000 gal) each
Number and size of batch vessels	12 @ 3,600 m <sup>3</sup> (950,000 gal) each
Cellulase loading	20 mg protein/g cellulose

The batch reactors are agitated and temperature-controlled using a pump-around loop that consists of a centrifugal pump (P-300) and a heat exchanger (H-300). During enzymatic hydrolysis, the temperature is maintained with cooling water. Temperature control during enzymatic hydrolysis is important. Enzyme studies at NREL have indicated an optimum temperature of 48°C for a number of commercial and development enzymes. A -5°C deviation could result in a dramatically reduced rate of reaction; a +5°C deviation could result in the onset of protein denaturation. Either situation would reduce the cellulose conversion yield for the same residence time.

Table 9 lists the reactions and conversions taking place during enzymatic hydrolysis. The saccharified slurry contains 11.7 wt % total soluble sugar (including oligomers), with 6.7% monomeric glucose and 3.7% monomeric xylose. As mentioned in Section 3.2, some of the more advanced enzyme preparations have shown a significant ability to also convert xylan to xylose. This additional conversion is captured in pretreatment so it is not included in Table 9. Note that glucose oligomers are modeled in Aspen as “glucose molecules in oligomeric form”; the actual size distribution of the oligomers is not captured.

**Table 9. Enzymatic Hydrolysis Reactions and Assumed Conversions**

Reaction	Reactant	% Converted to Product
$(\text{Glucan})_n \rightarrow n \text{ Glucose Oligomer}$	Glucan	4.0%
$(\text{Glucan})_n + \frac{1}{2}n \text{ H}_2\text{O} \rightarrow \frac{1}{2}n \text{ Cellobiose}$	Glucan	1.2%
$(\text{Glucan})_n + n \text{ H}_2\text{O} \rightarrow n \text{ Glucose}$	Glucan	90.0%
$\text{Cellobiose} + \text{H}_2\text{O} \rightarrow 2 \text{ Glucose}$	Cellobiose	100%

After 60 hours of additional enzymatic hydrolysis in F-300, the saccharified slurry is cooled by the pump-around loop and larger heat exchanger H-310 (specific to this task and shared between all the fermentors) to 32°C for fermentation. Recombinant *Zymomonas mobilis* bacterium is used as the ethanologen. This strain of *Z. mobilis* can simultaneously ferment glucose and xylose to ethanol. The present design assumes that the minor hemicellulosic sugar arabinose is also fermented to ethanol with the same yield as xylose, although this is a research target for 2012 and has not yet been demonstrated at NREL.

The inoculum protocol for *Z. mobilis* is a direct transfer of cells without a cell concentration step. In order to provide a required 10% inoculum volume back to the production fermentors, 10% of the saccharified slurry is split off to seed production (see PFD-P120-A301, Appendix E). Each seed train consists of five reactors operating in batch mode with a 24-hour batch time and an additional 12-hour turnaround time. The seed fermentors are cooled with chilled water from Area 900 to maintain the temperature at 32°C (90°F). The first vessel (40 gallons) is inoculated with a seed culture from the lab. Its broth is used to inoculate a larger reactor, and so on. After five

iterations, the cell mass from the last vessel (200,000 gallons) is sufficient to inoculate the production vessel. Following the 2002 design, it was decided that two trains would be optimal [2]. Using these conditions, the fifth reactor in Train A will complete fermentation at 180 hours. Train B will complete fermentation 12 hours later. Another 24 hours after that, Train A is again complete and the cycle continues. A discussion of seed train cycling can be found in the 2002 report. Table 10 summarizes the seed train design specifications. Additionally, 0.1% (w/v) sorbitol is used in the final seed fermentor to improve cell viability at high sugar concentrations [46, 47]. Sorbitol is not a component in the Aspen model, but it is reflected in the economics by purchasing an amount of sorbitol equivalent to 0.1% (w/v) of the sugar flow to the seed train, at a cost of approximately 0.7 cents/gal ethanol.

**Table 10. Seed Train Specifications**

Inoculum level	10 vol % of production vessel size
Batch time	24 h
Fermentor turnaround time	12 h
Number of trains	2
Number of fermentor stages	5
Maximum fermentor volume (F-305)	200,000 gal (757 m <sup>3</sup> )
Corn steep liquor (CSL) loading	0.50 wt %
Diammonium phosphate (DAP) loading	0.67 g/L fermentation broth (whole slurry)

Table 11 gives the reactions and conversions used in the seed fermentors to describe the microorganism growth and sugar metabolism. The fraction of sugar converted to cell mass is rather small. This is typical for *Z. mobilis* and is economically beneficial as well—most of the sugar entering the seed train is converted to ethanol, which is ultimately added to the production fermentors and recovered. So even though 10% of the saccharified slurry is diverted to produce the seed culture, its ethanol-producing potential is not lost. Other species (*E. coli* or yeast) could be expected to have cell mass yields about 2 times higher than that of *Z. mobilis* and thus produce modestly lower amounts of ethanol during seed culture propagation.

**Table 11. Seed Train Reactions and Assumed Conversions**

Reaction	Reactant	% Converted to Product
Glucose → 2 Ethanol + 2 CO <sub>2</sub>	Glucose	90.0%
Glucose + 0.047 CSL <sup>a</sup> + 0.018 DAP → 6 <i>Z. mobilis</i> + 2.4 H <sub>2</sub> O	Glucose	4.0%
Glucose + 2 H <sub>2</sub> O → 2 Glycerol + O <sub>2</sub>	Glucose	0.4%
Glucose + 2 CO <sub>2</sub> → 2 Succinic Acid + O <sub>2</sub>	Glucose	0.6%
3 Xylose → 5 Ethanol + 5 CO <sub>2</sub>	Xylose	80.0%
Xylose + 0.039 CSL + 0.015 DAP → 5 <i>Z. mobilis</i> + 2 H <sub>2</sub> O	Xylose	4.0%
3 Xylose + 5 H <sub>2</sub> O → 5 Glycerol + 2.5 O <sub>2</sub>	Xylose	0.3%
Xylose + H <sub>2</sub> O → Xylitol + 9.5 O <sub>2</sub>	Xylose	4.6%
3 Xylose + 5 CO <sub>2</sub> → 5 Succinic Acid + 2.5 O <sub>2</sub>	Xylose	0.9%

<sup>a</sup> Corn steep liquor (CSL) and diammonium phosphate (DAP) are both nitrogen sources required for *Z. mobilis* growth. The stoichiometry shown above is only used to balance the compositions assumed for nonstandard components like cell mass.

Two high-capacity transfer pumps (P-302) are used to transfer the seed to a holding tank (T-301) in a timely fashion (approximately 2.5 h). The seed hold tank (T-301) is sized to hold 20% more

than the fifth seed reactor (F-305). Another pump (P-301) feeds the seed to the production fermentation train.

Besides being fermented to ethanol, sugar may be lost to side products by contaminating microorganisms. A total of 3% of the sugars available for fermentation is assumed lost to contamination, as discussed in the 2002 design report. This is the level of contamination loss tolerated by the corn ethanol industry, so it can be thought of as an expected value consistent with good batch fermentor operation. The contamination loss is modeled by converting a fraction of the sugars to lactic acid upstream of the fermentor. This allows us to simply assign a percent loss to contamination in the model so the conversions in the fermentor do not have to be adjusted. Table 12 shows the contamination reactions only.

**Table 12. Co-Fermentation Contamination Loss Reactions**

<b>Reaction</b>	<b>Reactant</b>	<b>% Converted to Product</b>
Glucose → 2 Lactic Acid	Glucose	3.0%
3 Xylose → 5 Lactic Acid	Xylose	3.0%
3 Arabinose → 5 Lactic Acid	Arabinose	3.0%
Galactose → 2 Lactic Acid	Galactose	3.0%
Mannose → 2 Lactic Acid	Mannose	3.0%

Fermentation is conducted in a batch system of 950,000-gal vessels (F-300). The fermentation residence time is modeled as 36 hours. Inoculum from the seed train is fed at 10 vol % of the hydrolysate flow along with the nutrients corn steep liquor (CSL, 0.25 wt %) and diammonium phosphate (DAP, 0.33 g/L of whole slurry). The fermentors are cooled using the pump-around loop with H-300 switched from cooling water to chilled water from the coolant loop (Area 900). Agitation requirements in the main production reactors were reduced from those in the 2002 design. The main reactors (F-300) are agitated at 0.03 hp/1,000 gal (6 W/m<sup>3</sup>). The assumption is that most of the liquefaction and viscosity reduction of the slurry takes place in the continuous high-solids hydrolysis reactor, and vigorous agitation is not required in anaerobic *Z. mobilis* fermentation.

Table 13 summarizes the conditions in the fermentation vessels and Table 14 lists the reactions and conversions assumed in fermentation. Based on NREL's knowledge of state-of-the-art co-fermenting microorganisms, arabinose is assumed to have the same conversion to ethanol as xylose does. Conversion of galactose and mannose to ethanol is not assumed, in contrast to the 2002 design. Arabinose follows the xylose stoichiometry, with 85% conversion to ethanol. Inhibition effects from furans and acetate are not modeled explicitly in Aspen, having no kinetics available to do so, but they are implicit in the static conversions used in the model because these conversions are based on fermentation experiments carried out in the presence of these inhibitors. NREL does have an active research program in fermentation inhibitor characterization and mitigation [48], but the details of this program are beyond the scope of this process design report.



**Table 13. Co-Fermentation Conditions**

Organism	Recombinant <i>Zymomonas mobilis</i>
Temperature	32°C (96°F)
Initial fermentation solids level	19.8% total solids (14.7% soluble, 5.1% insoluble w/w)
Residence time	1.5 days (36 h)
Inoculum level	10 vol %
Corn steep liquor (CSL) level	0.25 wt %
Diammonium phosphate (DAP) level	0.33 g/L fermentation broth (whole slurry)

**Table 14. Co-Fermentation Reactions and Assumed Conversions**

Reaction	Reactant	% Converted to Product
Glucose → 2 Ethanol + 2 CO <sub>2</sub>	Glucose	95.0%
Glucose + 0.047 CSL <sup>a</sup> + 0.018 DAP → 6 <i>Z. mobilis</i> + 2.4 H <sub>2</sub> O	Glucose	2.0%
Glucose + 2 H <sub>2</sub> O → 2 Glycerol + O <sub>2</sub>	Glucose	0.4%
Glucose + 2 CO <sub>2</sub> → 2 Succinic Acid + O <sub>2</sub>	Glucose	0.6%
3 Xylose → 5 Ethanol + 5 CO <sub>2</sub>	Xylose	85.0%
Xylose + 0.039 CSL + 0.015 DAP → 5 <i>Z. mobilis</i> + 2 H <sub>2</sub> O	Xylose	1.9%
3 Xylose + 5 H <sub>2</sub> O → 5 Glycerol + 2.5 O <sub>2</sub>	Xylose	0.3%
Xylose + H <sub>2</sub> O → Xylitol + 0.5 O <sub>2</sub>	Xylose	4.6%
3 Xylose + 5 CO <sub>2</sub> → 5 Succinic Acid + 2.5 O <sub>2</sub>	Xylose	0.9%

<sup>a</sup> Corn steep liquor (CSL) and diammonium phosphate (DAP) are both nitrogen sources required for *Z. mobilis* growth. The stoichiometry shown above is only used to balance the compositions assumed for *Z. mobilis* cell mass. Nutrient requirements have not been optimized and a minimal, low-cost nutrient formulation has yet to be defined.

The fermentation broth or “beer” has an ethanol concentration of 5.4 wt % and is collected in the beer well (T-306). A small amount of additional ethanol is entrained in the CO<sub>2</sub> vent stream and will be recovered to the beer well via the vent scrubber. The beer well is designed for a residence time of 4 hours to provide surge capacity between fermentation and distillation.

### 3.3.3 Cost Estimation

In general, the material of construction for all equipment in this section is 304SS, which is the most cost-effective material for fermentation service. Carbon steel has been proposed as an alternative and does have a precedent in the corn ethanol industry with some technology providers. However, stainless steel is more common, and Harris Group felt that carbon steel fermentors would have to be designed thicker for corrosion allowance, which would mostly negate the capital savings from using the cheaper material. Carbon steel also tends to pit and can harbor biofilms, creating a contamination source.

The continuous enzymatic hydrolysis reactor (T-310) is envisioned in this design as an empty tower that is loaded from the top. Harris Group obtained a quote from Caldwell for eight such vessels to be run in parallel. These were flat-bottomed plug-flow reactors with a 10:1 height:diameter ratio. The larger vessels were quoted by Mueller: the million-gallon batch fermentors (F-300), the seed hold tank (T-301), and the beer well (T-306). Mueller also quoted the fourth and fifth seed fermentors (F-304, F-305), including internal cooling coils. The smaller seed fermentors (F-301, F-302, F-303) were quoted by A&B Process Systems as skidded units with cooling jackets and agitators. Harris Group developed costs for all of the pumps in this area using their internal equipment database. Costs for the larger agitators, i.e., those on the fermentors (A-300), the seed fermentors (A-304, A-305), and other large tanks (A-301, A-306),

were based on vendor (Lotus) quotes obtained by Harris Group. Large agitators tend to be top-mounted because they are more energy-efficient than side-entry agitators.

Harris Group obtained quotes from Alfa Laval for the plate and frame heat exchangers in this area (H-300, H-310). The incoming hydrolysate cooler is a shell-and-tube heat exchanger from Fox Engineering.

### 3.3.4 Achieving the Design Case

For the enzymatic hydrolysis and fermentation area, Table 15 shows the demonstrated results used in the State of Technology (SOT) cases from 2008 to 2010 and the ultimate 2012 targets (i.e., those used in the Aspen model).

**Table 15. Research Status and 2012 Targets in Enzymatic Hydrolysis and Fermentation**

	<b>2008 State of Technology</b>	<b>2009 State of Technology</b>	<b>2010 State of Technology</b>	<b>2012 Targets</b>
Total solids loading (wt %)	20%	20%	17.5%	20%
Enzymatic hydrolysis substrate	Washed-solids	Washed-solids	Washed-solids	Whole-slurry
Combined hydrolysis and fermentation time (days)	7	5	5	5
Corn steep liquor loading (wt %)	1%	1%	1%	0.25%
Overall cellulose to ethanol conversion (through hydrolysis and fermentation,%) <sup>a</sup>	85.5%	84%	87%	85.5%
Xylose to ethanol fermentation conversion (%)	80%	82%	79%	85%
Arabinose to ethanol fermentation conversion (%)	0%	51%	68%	85%

<sup>a</sup> Assumes 95% glucose-to-ethanol conversion.

Enzymatic hydrolysis and fermentation experiments are typically “integrated” with pretreatment, meaning that a single large batch of pretreated material is used to perform many hydrolysis and fermentation experiments. Integrated performance results for the process configuration and operating conditions assumed in the 2002 design (i.e., 20% total solids loading with overliming) [2] were first produced in 2005. In 2008, integrated experimental results advanced significantly toward the 2012 targets following the replacement of overliming with ammonium hydroxide conditioning, which demonstrated a slightly improved cellulose-to-ethanol yield and significantly better xylose-to-ethanol yield due to decreased sugar losses and improved hydrolysate fermentability [32].

#### *Enzymatic Hydrolysis*

In all of the SOT experiments shown in Table 15, the pretreated hydrolysate underwent solid-liquid separation and the liquor was conditioned with ammonium hydroxide as described previously. In these so-called washed-solids experiments, enzymatic hydrolysis was performed only on the pressed and washed pretreated solids (i.e., in the absence of pretreatment liquor). The conditioned liquor was added back to the hydrolysate slurry just before fermentation. The 2012 targets for enzymatic hydrolysis, however, assume a whole-slurry process, in which the whole pretreated slurry is neutralized, hydrolyzed, and fermented without a complicated and costly solid-liquid separation step. Based on bench-scale testing at NREL, Larox (now Outotec) helped

to estimate the purchased capital cost of a hydrolysate pressure filter system at the present design flow as being on the order of \$30MM minimally. The solid-liquid separator cost used in the 2002 design was only about \$5MM. We suspect that the older cost estimate was extremely optimistic. In general, we have found a considerable discrepancy in the cost of solid-liquid separation technology being quoted now compared to what was quoted in the 1990s and 2000s, though we have not investigated why this might be so.

In 2009, NREL began studying whole-slurry enzymatic hydrolysis in earnest because advanced enzyme preparations became available that could perform satisfactorily on this material. One advanced preparation was tested at the pilot scale and performed very well, achieving 91% cellulose-to-glucose conversion in initial process-relevant whole-slurry enzymatic hydrolysis experiments on a 2008 batch of pretreated corn stover (PCS) in which a 75% xylan-to-xylose conversion was achieved in pretreatment (see Table 7). Previously, cellulose-to-glucose conversions of 90% were not uncommon in washed-solids hydrolysis experiments, but this enzyme was the first tested at NREL to demonstrate such a high conversion in a whole-slurry experiment.

As described in Section 3.2, the direction in NREL pretreatment research has been toward lower-severity processes that rely on secondary thermochemical or enzymatic hydrolysis to convert xylose oligomers to monomers. The reduced severity also affects cellulose digestibility. In newer batches of PCS that have higher ( $\geq 80\%$ ) xylose yield, the glucose yield from cellulose is lower for the same total solids loading. Loss of conversion may be counteracted to a degree by reducing the solids loading or by employing pretreatment-related process steps such as deacetylation and/or disc-refining, as discussed in Section 3.2.4. Whole-slurry hydrolysis results using the advanced enzyme preparation are summarized in Table 16.

**Table 16. Summary of Integrated Whole-Slurry Enzymatic Hydrolysis Performance Using an Advanced Enzyme Preparation**

<b>SOT Year</b>	<b>PCS Batch</b>	<b>Total Solids Loading (wt %)</b>	<b>Glucose Yield from Cellulose</b>
2009	2008: 75% xylose	20%	91%
2009	2009: 80% xylose	20%	83%
2010	2010: 80% xylose	20%	84%
2010	2010: 80% xylose	17.5%	86%
2010	2010: 80% xylose	15%	90%

Cellulose-to-glucose conversion in these experiments is approaching the 2012 targets (90% conversion at 20 wt % total solids), but it is not there yet. Achieving these targets will require use of one of the rapidly-improving enzyme preparations being developed by NREL's industrial collaborators or through DOE's ongoing enzyme solicitation focused on the development of advanced enzyme systems [49]. In addition to cellulase activity, these advanced enzyme preparations will likely have hemicellulase activity, enabling less severe pretreatment. Accessory enzymes (e.g., ferulic acid esterase) may also be present in advanced cocktails to more efficiently hydrolyze the bonds within and linkages between cellulose, hemicellulose, and lignin. NREL will continue to monitor the performance of these evolving enzyme preparations as well as the cost of solid-liquid separation technologies in order to choose the most cost-effective process option for demonstration in 2012.

### Fermentation

NREL continues to perform integrated fermentation experiments using the recombinant, co-fermenting *Z. mobilis* strain 8b. As of 2010, the ethanol tolerance limit of this microorganism has become the major barrier in NREL fermentation research. In co-fermentation, this strain readily consumes all of the available glucose, and we assume 95% is converted to ethanol. This microorganism will further consume the xylose in the system, producing ethanol until it reaches its ethanol tolerance limit of approximately 60 g ethanol/L. (In practice, the presence of typical fermentation inhibitors from biomass hydrolysate drives the limit to <60 g/L.)

As discussed above, sugar yields from pretreatment and enzymatic hydrolysis have been steadily increasing. This has led to lower percent xylose utilizations in fermentation experiments, especially those performed at higher total solids loadings where the xylose is more concentrated. Characteristic ethanol yields from xylose in the 2009 and 2010 SOT cases are shown in Table 17. Even though the amount of available sugar changes in each case, the final ethanol concentration is more or less constant (within the accuracy of the measurement) and is indicative of the microorganism's practical ethanol tolerance limit. At 20% total solids in 2009, the microorganism was able to convert 82% of available xylose before reaching its limit. In 2010, the same limit was reached after converting only 63% of available xylose. In other words, the results summarized in Table 17 suggest that *Z. mobilis* strain 8b was operating very close to its ethanol tolerance limit in 2009 and was most likely being inhibited by ethanol in 2010 when the sugar concentrations increased.

**Table 17. Ethanol Yields from Xylose**

% Total Solids in Fermentation	2009 SOT		2010 SOT	
	Xylose Conversion	Final Ethanol Conc. (g/L)	Xylose Conversion	Final Ethanol Conc. (g/L)
15%	-	-	78%	49
17.5%	-	-	79%	53
20%	82%	52	63%	53
25%	-	-	20%	50

Ethanologen strain research is currently being performed outside of NREL through ongoing DOE solicitation projects [50]. The companies participating in these projects are tasked with improving the ethanol tolerance of co-fermenting microorganisms like *Z. mobilis* to alleviate the problem of reduced ethanol yield at high sugar concentrations. Despite the highly sensitive nature of strains (ease of propagation, value of intellectual property, etc.), NREL expects to receive some of these strains for testing in 2011 and we hope to be able to demonstrate better ethanol tolerance from one or more of these strains under integrated processing conditions.

The fermentation strain solicitation awardees were also tasked with demonstrating improved conversion of the minor hemicellulosic sugars (arabinose, galactose, and mannose) to ethanol. Arabinose is the third most abundant sugar available in corn stover following glucose and xylose, making up about 5% of the total available sugar. Achieving an 85% arabinose-to-ethanol yield provides an additional 3 gallons of ethanol per ton of dry corn stover and decreases the MESP by about \$0.08/gal compared to the MESP with zero conversion of arabinose. Galactose accounts for another 2.5% of the available sugar, and mannose content in corn stover is typically negligible. As of 2008, it was clear that the solicitation awardees were not likely to make

significant progress on galactose or mannose conversion but that conversion of arabinose to ethanol was possible through incorporation of known arabinose metabolic pathways. In 2010, one of the awardees reported to DOE that they had demonstrated arabinose conversions of 68% on pure arabinose and 90% when glucose was dosed along with arabinose. The specifics of these experiments are protected information and cannot be shared here. NREL has also begun a program to genetically engineer the arabinose fermentation pathway into the *Z. mobilis* 8b strain to reduce the risk that the proprietary ethanologens being developed through the DOE strain solicitation are unable to meet the 2012 cost targets [51].

#### *Low-Cost Media*

As seen in Table 15, corn steep liquor (CSL) is assumed as a nutrient source for ethanol fermentation. While NREL does not actually use CSL in routine laboratory or pilot plant experiments, its use is assumed in the techno-economic model as a placeholder for a low-cost source of nitrogen and trace minerals, and reducing the quantity of this material used in fermentation is a 2012 target. CSL, a by-product of the corn wet milling process, is high in protein, vitamins, and minerals and is usually mixed with the corn fiber by-product and sold as gluten feed [52]. On its own, CSL is used as a nutrient source in many fermentation industries including wet-mill corn ethanol, pharmaceuticals, and industrial enzyme production. Because CSL is a wet mill by-product, and the corn starch business is relatively static, there is in effect a fixed amount of CSL available in the United States. We have performed some projections elsewhere and have determined that it is unlikely that CSL could scale to support cellulosic ethanol production at commercial volumes of billions of gallons per year [51]. Finding another low-cost and scalable nutrient source is a subject of future NREL research and techno-economic analysis.

### 3.4 Area 400: Cellulase Enzyme Production

#### 3.4.1 Overview

This process area produces cellulase enzyme that is used in Area 300 to hydrolyze cellulose into glucose. Cellulase refers to a mixture of enzymes (catalytic proteins) that includes: (1) endoglucanases, which attack randomly within the cellulose fiber, reducing polymer chain length rapidly; (2) exoglucanases, which attack the ends of highly crystalline cellulose fibers; and (3)  $\beta$ -glucosidase, which hydrolyzes the small cellulose fragments (cellobiose, a glucose dimer) to glucose. Cellulase is produced industrially using (among other microorganisms) *Trichoderma reesei*, a filamentous fungus that secretes high levels of cellulase enzymes when grown aerobically in the presence of cellulose or other cellulase inducers.

The 1999 design report [1] introduced Area 400 to produce cellulase on-site with ethanol, using a slipstream of the conditioned hydrolysate slurry from pretreatment. The 2002 design report [2] omitted Area 400 in favor of a purchased-enzyme model in which the enzyme was assigned a certain fixed cost contribution per gallon of ethanol. Area 400 was reinstated for this design report with new reactor design assumptions and several other improvements over the 1999 cellulase enzyme production model. We note that by including an on-site enzyme production section, NREL and DOE are not making a judgment about whether or not the cellulosic ethanol industry should align to this mode of enzyme distribution. Rather, the model on-site enzyme section is intended to improve transparency in determining the true cost of cellulase enzymes for large-scale cellulosic ethanol production.

The present design considers submerged aerobic cultivation (“aerobic fermentation”) of a *T. reesei*-like fungus on a feedstock of glucose and fresh water. Producing cellulase enzymes with glucose is not straightforward, because the absence of cellulose does not encourage the microorganism to secrete cellulase enzymes. Here, we have assumed a media preparation step where a small fraction of glucose is converted to sophorose, a powerful inducer of cellulase, using a small amount of the cellulase enzyme itself. When grown on this substrate, *T. reesei* has been shown to productively secrete cellulase [53]. Using glucose as the substrate is not necessarily more expensive than using hydrolysate slurry from pretreatment because the expected enzyme titer is significantly higher with glucose, reducing the capital and utility costs compared with using hydrolysate. Figure 9 is a simplified flow diagram of the enzyme production section.

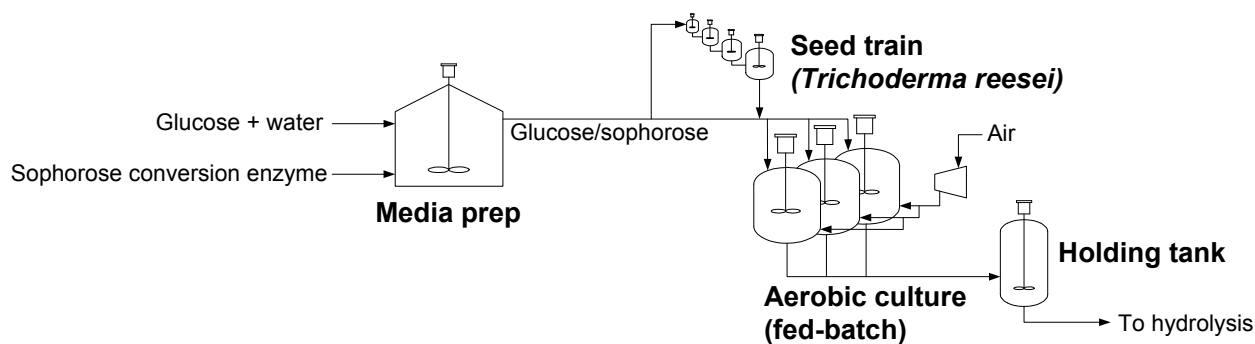

Figure 9. Simplified flow diagram of the enzyme production process

### 3.4.2 Design Basis

The on-site enzyme process was designed without input from enzyme companies or other protein production experts, although several individuals knowledgeable about this topic did participate in the peer review of this report. Based on the claims in U.S. Patent 4,762,788 (Example 5) [54] and a few reasonable assumptions, we have developed a rudimentary process that is adequate for our needs. The key assumptions used in the current design are summarized in Table 18. Note that the mass yield of enzyme from glucose is actually a computed number that is dependent on assumptions regarding protein composition and microorganism-specific productivity, which will be described below.

**Table 18. Area 400 Guiding Design Basis Assumptions**

<b>Parameter</b>	<b>Assumption</b>
Protein loading to enzymatic hydrolysis	20 mg protein/g cellulose
Reactor size	300,000 L @ 80% final working volume
Enzyme titer at harvest	50 g/L
Mass yield of enzyme from glucose	0.24 kg enzyme/kg glucose
Enzyme production cycle time	120 h online, 48 h offline, 168 h total

The desired cellulase loading to enzymatic hydrolysis is 20 mg of enzyme protein per g of cellulose. “Protein” here refers to the total amount of high molecular weight protein in the enzyme broth as determined by assay; not all of this protein is active cellulase. The total protein demand was thus calculated to be 490 kg/h (1,080 lb/h). An additional 10% is produced to account for the slipstream provided to the media preparation tank to make the glucose/sophorose mixture. The size of the cellulase production vessels was chosen to be 300 m<sup>3</sup> (80,000 gal) with a height-to-diameter ratio (H/D) of 2. Fermentation is assumed to be a fed-batch process starting at 50% working volume and ending at 80%. Over one week, each bioreactor will see a 24-hour cell growth period, a 96-hour protein production period, and a 48-hour offline period for draining, cleaning, and refilling. With a one-week total cycle time and the production parameters listed in Table 18, one bioreactor is capable of producing 12,000 kg of protein in a week, or 71.4 kg/h (157 lb/h). The equivalent enzyme volumetric productivity is 0.30 g protein/L-h. Nine reactors were therefore required to deliver the 490 kg/h of protein needed for enzymatic hydrolysis.

The reactors are loaded initially with the glucose/sophorose carbon source and nutrients including corn steep liquor (CSL), ammonia, and SO<sub>2</sub>. After the initial cell growth period, additional substrate is added to maintain protein production. The bioreactors are sparged with compressed and cooled air and corn oil is added as an antifoam. The reactors are temperature-controlled by chilled water flowing through internal coils.

To determine the aeration and agitation requirements for the production bioreactors, the oxygen transfer rate was set equal to the oxygen uptake rate (OTR=OUR), with the OUR computed stoichiometrically from the protein production rate. In the modeled bioreactors, the reaction stoichiometry balances the reactions of substrate, oxygen, ammonia, and SO<sub>2</sub> to cell mass and enzyme (plus CO<sub>2</sub> and water) using an elemental composition for commercial cellulase provided by Novozymes [55]. The composition of cell mass was taken as the average of a generic cell mass composition [56] and the enzyme composition, with the assumption that cell mass includes some unreleased protein.

Cellulase protein:  $\text{CH}_{1.59}\text{N}_{0.24}\text{O}_{0.42}\text{S}_{0.01}$

*T. reesei* cell mass:  $\text{CH}_{1.645}\text{O}_{0.445}\text{N}_{0.205}\text{S}_{0.005}$

In the production bioreactors, it is assumed that 90% of the carbon source is converted via the protein reaction and 10% is converted via the cell mass reaction. In the seed reactors, 85% of the carbon is converted via the cell mass reaction and 5% via the protein reaction, with 10% unreacted. This represents an overall molar selectivity of glucose to 31% protein, 4% cell mass, and 65%  $\text{CO}_2$ , yielding 0.24 kg enzyme protein/kg glucose. The total oxygen demand for one bioreactor producing 12,000 kg protein in 120 hours online is 8.4 kmol/h. At its maximum (i.e., at the initial working volume of 50%), the OUR is 56 mmol/L-h.

The OTR is the product of the volumetric mass transfer coefficient  $k_L a$  ( $\text{h}^{-1}$ ) and the log mean oxygen concentration gradient (the difference between the saturated dissolved oxygen concentration and the desired dissolved oxygen concentration) at the top and bottom of the bioreactor operating volume:

$$\text{OTR} = k_L a \frac{(C_b^* - C_D) - (C_t^* - C_D)}{\ln\left(\frac{C_b^* - C_D}{C_t^* - C_D}\right)}$$

where  $C_b^*$  and  $C_t^*$  are the saturated dissolved oxygen concentrations (mmol/L) at the bottom and top of the vessel, respectively, and  $C_D$  is the desired dissolved oxygen concentration, which is assumed to be 30% of saturation at 1 atm absolute pressure (0.063 mmol/L). The top and bottom concentrations of saturated dissolved oxygen were calculated by Henry's Law:

$$\pi = H C_L$$

where  $\pi$  is the partial pressure of oxygen (atm),  $H$  is Henry's coefficient (atm/(mmol/L)), and  $C_L$  is the liquid concentration of the gas (mmol/L). Henry's coefficient for oxygen in water was set equal to 1 atm/(mmol/L) for all calculations. (Henry's coefficient for oxygen in pure water is approximately 1.3 atm/(mmol/L) at 25°C, but solubility may be affected by the non-water components in the broth; a coefficient of 1 is a reasonable initial estimate.) The pressure at the top of the vessel was taken to be 1 atm and the pressure at the bottom was determined by the static head of liquid in the vessel. The volumetric mass transfer coefficient was then computed using the following correlation [57]:

$$k_L a \text{ (h}^{-1}\text{)} = 8.42 \left(\frac{P}{V_L}\right)^{0.33} V_G^{0.56}$$

where  $P$  is the impeller power consumption and  $V_L$  is the working volume. The correlation assumes that  $P/V_L$  is expressed in hp/1,000 L.  $V_G$  is the superficial gas velocity (cm/s) in the head space. This correlation is intended for non-Newtonian fungal cultivation systems with a maximum volume of 30  $\text{m}^3$ . Our bioreactors exceed the maximum intended volume for this correlation by several orders of magnitude but we believe that this equation yields results that are reasonable enough in the absence of more sophisticated reactor design involving computational fluid dynamics and so on.



Because we have assumed a fed-batch fermentation, the working volume varies over time, along with the OTR and aeration rate in vvm (standard volume of air per volume of liquid per minute), which are volumetric quantities. In absolute terms, the average aeration rate for a  $V_G$  of 200 cm/min was 0.83 standard m<sup>3</sup>/s (including two days of offline time). The average impeller power  $P$  was determined to be 260 kW (350 hp), with a maximum of 600 kW (800 hp). The final specifications for the cellulase production bioreactors are shown in Table 19.

**Table 19. Specifications of the Enzyme Production Bioreactors**

Total volume	300 m <sup>3</sup> / 80,000 gal
Maximum working volume	80%
H/D ratio	2
Height	11.5 m
Diameter	5.75 m
Operating pressure	1 atm
Operating temperature	28°C (82°F)
Material	316SS
Agitator	800 hp

Four trains of three seed fermentors provide inoculum to the production bioreactors. Each vessel in the seed trains is run batchwise on the same substrate as the production vessels. Air is also sparged through each of the seed vessels, which are cooled with chilled water. The seed bioreactors are each sized at 10% of the next bioreactor volume, i.e., 0.3 m<sup>3</sup>, 3 m<sup>3</sup>, and 30 m<sup>3</sup>. The aeration demand is assumed to be 10% of the production aeration rate. Four trains were chosen because each production fermentor has a total cycle time of 7 days, while each seed fermentor should have a cycle time of 2 days (including cleaning and sterilization) to get through the cell growth phase only.

Like the oxygen uptake rate, the glucose demand is also computed stoichiometrically from the required protein production rate. Ammonia and SO<sub>2</sub> are fed to the reactors stoichiometrically and CSL, trace nutrients, and antifoam (corn oil) are added to the substrate based on flow rate. The required nutrient concentrations are taken from Schell et al. [58] and are restated in Table 20.

**Table 20. Cellulase Production Nutrient Requirements**

Component	Amount
Ammonia	Stoichiometric (approx. 7 g/L)
SO <sub>2</sub>	Stoichiometric (approx. 0.6 g/L)
CSL	1% w/w
Corn oil	0.1% v/v
Ammonium sulfate	1.4 g/L
Potassium phosphate	2.0 g/L
Magnesium sulfate	0.3 g/L
Calcium chloride	0.4 g/L
Tween 80	0.2 g/L

Glucose, the carbon source for cell mass and protein, is the most significant enzyme production expense in this model. Electricity is also a significant contributor due to the power requirements of air injection, agitation, and refrigeration. The electricity demand in the enzyme production area is summarized in Table 21.

**Table 21. Cellulase Production Electricity Requirements**

Air compressor	1,408 kW
Agitators	2,326 kW
Chiller system (Area 400 contribution)	1,587 kW
Total electricity (includes pumps, etc.)	5,340 kW
Total electricity demand per kg protein	9 kWh/kg

### **3.4.3 Cost Estimation**

Most equipment in this area is stainless steel. The air compressor and some of the nutrient delivery equipment items are specified as carbon steel. Harris Group obtained quotes for the production bioreactors (F-400) from Mueller, with internal cooling coils included. The production agitators and motors were quoted by Lotus. The smaller seed fermentors were quoted by A&B Process Systems as complete skid-mounted units with cooling jackets and agitators. The air compressor is a packaged unit from Dresser Roots, capable of delivering 8,000 SCFM of air at 3 atm. Harris Group developed costs for the pumps in this area using their internal database.

Not included in the enzyme production model are any costs for concentration, stabilization, or transportation of the enzyme to the plant. At the very least, one expects to have to pay licensing fees for the cellulase production microorganism, but these costs are not included because we lack information on what they might be (though an educated guess might be 5 cents or less per gallon of ethanol).

### **3.4.4 Enzyme Cost Discussion**

The 2002 design model and subsequent analyses using that model assumed that cellulase enzymes had a fixed contribution to the MESP that was independent of the ethanol yield. This value was taken from the Multi-Year Program Plan (MYPP) of DOE's Office of the Biomass Program [27], which in earlier editions stated that using technology available in 2009, the enzyme cost contribution should be \$0.35/gal (2007\$) and should decrease to \$0.12/gal ethanol by 2012. These values were computed by NREL based on projections made by enzyme companies in 2005, following a DOE-funded research campaign that helped to significantly reduce cellulase enzyme production costs [59]. Enzyme costs in this range were considered realistic if production costs associated with transportation and formulation costs were eliminated, i.e., if the enzymes were produced on-site or near-site and were not formulated for stability during extended storage [60, 61].

Since the 2005 projections, DOE negotiated additional awards with several enzyme manufacturers [49] to further develop improved cellulase preparations and drive down production costs to the levels specified in the MYPP. In the process, DOE and NREL both received feedback from the enzyme industry that even \$0.35/gal might be too optimistic for currently-available enzymes. Along those lines, in February 2010 the major enzyme manufacturers Genencor and Novozymes announced new commercial-grade cellulase enzyme preparations capable of higher performance at lower loadings. Both cited an enzyme cost contribution of approximately \$0.50/gal ethanol [62, 63].

Based on the economics of the on-site enzyme section described above, the predicted cost of enzymes to the ethanol plant is \$0.34/gal of ethanol. This is broken down as shown in Figure 10.

The carbon source (glucose) makes up 57% of the cost of the enzyme, i.e., \$0.19/gal of the \$0.34/gal is just for glucose. We can back out the unit cost of the enzyme from \$0.34/gal by multiplying by the ethanol production rate and dividing by the enzyme flow rate, which works out to \$4.24/kg protein.

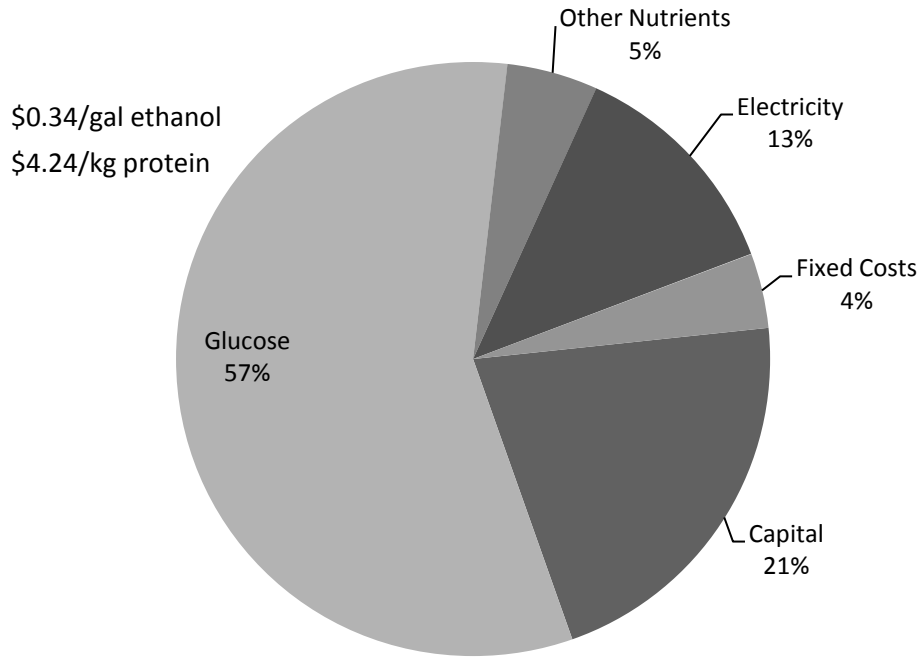

DW1102A

**Figure 10. Enzyme production cost breakdown**

The previous DOE target for enzyme cost was specified as \$0.12/gal ethanol, or about one third of what is reported here. One way to achieve such a low cost contribution would be to reduce the enzyme loading. In Figure 11, we see that the enzyme contribution to MESP is roughly linear with the enzyme loading (mg of enzyme per g of cellulose entering enzymatic hydrolysis). At the loading specified in the present design (20 mg/g), the enzyme contribution is \$0.34/gal. The enzyme contribution approaches \$0.12/gal at about 8 mg/g loading. Therefore, the original enzyme cost targets could potentially be achieved by a reduction in enzyme loading, but such a loading would be significantly lower than what we currently use to approach the 90% cellulose conversion yield target.

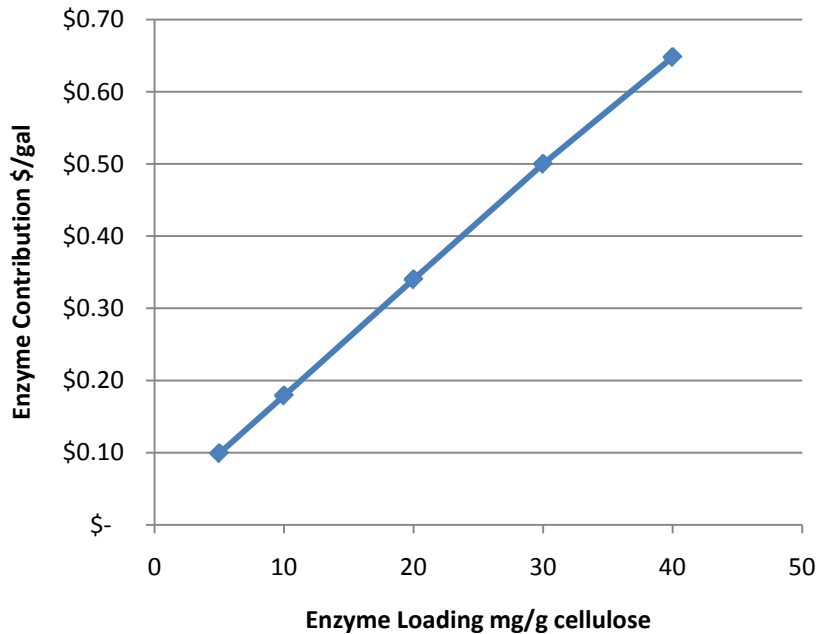

**Figure 11. Enzyme contribution to MESP as a function of loading**

The lower limit of enzyme loading is not well understood. In theory, enzyme molecules are not consumed during the hydrolysis reaction but, over time, they may become inactivated by denaturation or irreversible binding to solid particles, especially when lignin is present. Bench- and pilot-scale experiments at NREL are therefore typically overloaded (i.e., an excess of enzyme is used) to ensure complete hydrolysis, because we may only have the resources to run a limited number of experiments. However, we have observed that advanced enzymes demonstrate diminishing increases in conversion at loadings as low as 20 mg/g. Ultimately, the lower limit of enzyme loading will be determined by industry and enzyme manufacturers, and will likely decrease as pretreatment technologies and enzyme preparations continue to improve. For the present design, however, NREL was not comfortable modeling an enzyme loading less than 20 mg/g.

The enzyme cost contribution modeled here is lower than one would expect for an enzyme preparation purchased from a separate, non-adjacent production facility. Transportation of the enzyme to the ethanol plant could alone add \$0.09–\$0.18/kg of product, even if formulation costs could be avoided. Furthermore, by lumping the enzyme production equipment in with the ethanol plant, some key items are inherently shared, e.g., the land and buildings, cooling tower, and utilities infrastructure. Overhead and fixed costs, especially labor and management, would also be higher for a standalone facility. Eliminating the shared aspects between the enzyme unit and the ethanol plant could easily add another 5 cents per gallon of ethanol to the enzyme contribution. Additionally, an external enzyme production facility would probably demand a higher rate of return than the 10% IRR assumed for the ethanol plant because it is a higher-risk and lower-volume business. Including all these extra costs would bring the total enzyme cost contribution in line with the \$0.50/gal level cited in the press.

Although the on-site enzyme cost contribution derived in our analysis is lower than what might be expected in a purchased-enzyme scenario, it does not necessarily make a strong argument for on-site production. The cellulase production unit described here, consisting of nine fermentors and four seed trains, is hardly a “plug-and-play” solution, and an ethanol producer could be forgiven for not wanting to assume the mantle of logistical and operational challenges associated with such a system. However, the cost benefits of co-location are real, and the economics of cellulase production are arguably so tightly coupled to those of the fuel product itself that an on-site cellulase facility might ultimately make economic sense in the future cellulosic ethanol industry. In the near term, however, it is more likely that ethanol plants will purchase enzyme from an external supplier who has an organization dedicated to improving enzyme performance and reducing costs.

### 3.5 Area 500: Product, Solids, and Water Recovery

#### 3.5.1 Overview

Area 500 separates the fermentation broth from Area 300 into water, anhydrous ethanol, and combustible solids. Distillation and molecular sieve adsorption are used to recover ethanol from the raw fermentation beer and produce 99.5% ethanol. Distillation is accomplished in two columns. The first, called the beer column, removes the dissolved CO<sub>2</sub> and most of the water. The second column is called the rectification column and concentrates the ethanol to a near-azeotropic composition. See Figure 12 for a process overview of this area.

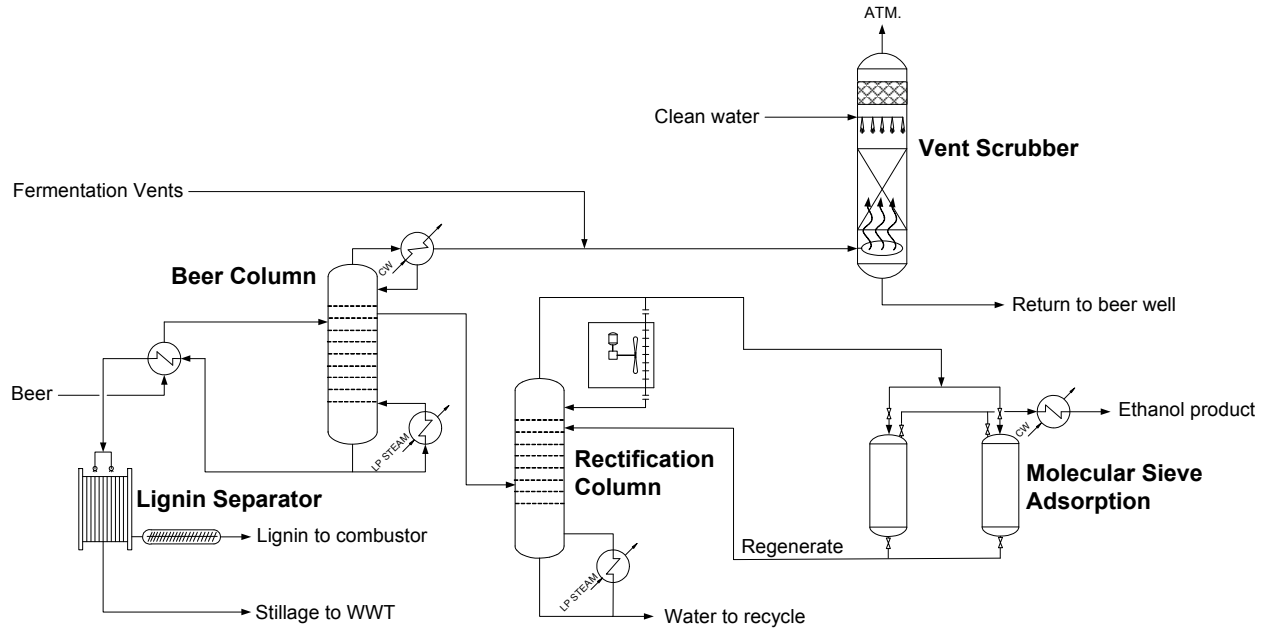

Figure 12. Simplified flow diagram of the separation process

The ethanol product leaves the rectification column at ~92.5% ethanol and is further dehydrated to 99.5% by vapor-phase molecular sieve adsorption. During regeneration of the adsorption columns, a low-purity (70 wt %) ethanol stream is generated and is recycled back to the rectification column for recovery. The beer column overhead stream is fed to a water scrubber along with the fermentation vents (containing mostly CO<sub>2</sub> but also some ethanol), thereby recovering nearly all of the ethanol. The scrubber effluent is fed back to the beer well.

The beer column bottoms (stillage) stream contains the unconverted insoluble and dissolved solids. The insoluble solids are dewatered by a pressure filter and sent to the combustor in Area 800. The pressed stillage water cannot be recycled directly back to the process because it contains high levels of organic salts such as ammonium acetate and ammonium sulfate, fermentation nutrients not consumed by the organism, and soluble inorganic compounds from the biomass. Instead, the pressed stillage water is directed to wastewater treatment (Area 600) for cleanup.

### 3.5.2 Design Basis

Beer from the fermentation area (5.4 wt % ethanol) is fed to the beer column after passing through an economizing heat exchanger with the bottoms stream (PFD-P120-A501, Appendix E). The beer column (D-501) operates in a mode that removes the CO<sub>2</sub> and as little ethanol as possible to the overhead while removing about 90% of the water to the bottoms. The ethanol is removed as a vapor side-draw from the column and fed directly to the rectification column (D-502). Both columns are modeled with rigorous vapor-liquid equilibrium calculations in Aspen using the RADFRAC model. This is an improvement over the 2002 Aspen model, where the rectification column was modeled as a fixed separation block. This results in a more accurate determination of reboiler and condenser duties for the columns. We note that our Aspen model was not used by the distillation vendor (Megtec) in designing these columns—they arrived at a similar design using their own models.

In the Aspen model, the beer column (D-501) contains 32 stages operating at 48% efficiency, with the feed entering on the fourth tray from the top. The molar reflux ratio required is 3:1. The overhead is vented to the scrubber and contains 85% CO<sub>2</sub>, 11% ethanol, and close to 4% water. All of the CO<sub>2</sub> and only 0.3% of the ethanol entering the beer column is vented here. Most of the ethanol that is vented (99%) will be recovered in the vent scrubber and recycled. In addition, about 0.8% of the ethanol fed to the beer column is lost in the bottoms stream and is considered a permanent loss. More than 99% of the ethanol in the feed is removed as a vapor side-draw from the column at Tray 8 at 40 wt %. To minimize the ethanol loss in the bottoms, the beer column reboiler duty is kept relatively high, so there is a trade-off between ethanol loss and energy usage. Megtec designed the beer column with 32 fixed-valve trays. These have been found to tolerate solids well and have a reasonably good efficiency. The tray spacing is 24 in. and the column diameter is 14 ft. Heat is supplied to a forced-circulation reboiler (H-501) by low-pressure (9.5 atm [125 psig]) steam. The forced-circulation reboiler was considered necessary to accommodate the solids present in the beer column bottoms. The beer column is operated at 2 atm (15 psig) overhead pressure to keep the reboiler temperature low in order to minimize fouling.

The vapor side-draw from D-501 is fed directly to the rectification column, D-502. This column uses 45 stages with an efficiency of 76%. The D-501 vapor is fed on Tray 33 (counting from the top). The recycle from the molecular sieve, which is higher in ethanol (72 wt % versus 40 wt %), is fed on Tray 14. The required molar reflux ratio is 3.5:1 to obtain a vapor overhead mixture of 92.5% w/w ethanol and a bottoms composition of 0.05% w/w ethanol. Only 0.1% of the ethanol from fermentation is lost in the bottoms. The rectification column bottoms stream is recycled to the pretreatment reactor as dilution water; ethanol in this stream is not considered a loss. The 7.5% water in the rectification column overhead represents only 0.7% of the water originally entering distillation. Megtec designed the rectification column with 45 valve trays. Above Tray 15, the column is 13 ft in diameter; below Tray 15 it is 4.5 ft in diameter. (Structural supports for this tower are included in its installation cost.) Heat is supplied to the column in a thermosiphon reboiler (H-502) by low-pressure steam. For the present design, an air-cooled condenser was specified to condense the reflux. This was done to reduce evaporative losses from the cooling tower and will be discussed more in Section 5.2.

The ethanol-containing vent from the beer column overhead, along with the vents from the seed and production fermentors in Area 300, is sent to a water scrubber (T-512). The scrubber column

recovers 99% of the vented ethanol. The scrubber effluent contains 1.8 wt % ethanol and is returned to the beer well. The scrubber is designed for absorption of >99% of the ethanol in the vents and no more than 40 tons per year of VOC (volatile organic compound) emissions for air pollution considerations. Higher water flow or lower water temperature could reduce VOC emissions from the vent scrubber, at a potentially significant increase in operating cost and water consumption.

The overhead vapor from D-502 is fed to a molecular sieve adsorption unit (M-503), which is a system of columns packed with beds of adsorbent. Water is selectively adsorbed in the beds as the vapor flows through. The design specifics of this unit are not detailed here, but the general arrangement is given in PFD-P120-A503 (Appendix E). Saturated vapor from the rectification column is superheated and fed to one of two adsorption columns. The adsorption column removes 95% of the water and a small amount of ethanol. The 99.5% pure ethanol vapor is cooled by heat exchange with the regeneration condensate and finally condensed with cooling water and pumped to storage. While one bed is adsorbing water, the other is regenerating. The bed is regenerated by passing a small slipstream of pure ethanol vapor back through the water-saturated bed while a vacuum is applied. The ethanol strips the water off the adsorbent, and the mixture is condensed and returned to the rectification column (D-502).

Finally, the beer column (D-501) bottoms stream is cooled to 47°C (117°F) in the feed/bottoms economizer; this is a suitable temperature for liquid-solid separation. The cooled material is separated in a pressure filter (S-505, PFD-P120-A505). The pressure filter is operated without a wash, and the cake is dried with air to 35% moisture. The drying air is sent to the combustor, and the pressed stillage water is sent to wastewater treatment in Area 600. This is a significant change from the 2002 process, in which the stillage was evaporated to a combustible syrup, with the evaporator condensate being recycled to the process. The effects of this change on the wastewater treatment area will be discussed in Section 3.6.

A clean-in-place system (part of Area 900) services the equipment in this area that is prone to fouling (e.g., the beer column reboiler) by flushing with a hot caustic solution and circulating the solution until heat transfer surfaces are clean. Manual acid cleaning must be performed occasionally to remove mineral scale.

### **3.5.3 Cost Estimation**

The construction material for equipment in the distillation area is generally 316SS. The beer column and rectification column were quoted by Megtec. The two columns were quoted as a package along with all pumps, heat exchangers (except the rectification column condenser), and reflux drums. The air-cooled rectification column condenser was quoted by GEA Rainey. The molecular sieve adsorption unit was quoted by Delta-T and the vent scrubber system was quoted by Envitech. The lignin separator was quoted by Larox as two FFP 2512 60/60 filter-press units. Harris Group used information and experience from other projects to estimate costs for the rest of the equipment, including solids handling equipment, pumps, and auxiliary tanks.



## 3.6 Area 600: Wastewater Treatment (WWT)

### 3.6.1 Overview

The ethanol process generates a number of wastewater streams that must be treated before recycle to the process or release to the environment. This is accomplished in the wastewater treatment system in Area 600. The treated water is assumed clean and fully reusable by the process, which reduces both the fresh makeup water requirement and discharge to the environment.

Figure 13 is a simplified flow diagram of the WWT area. Condensed pretreatment flash vapor, boiler blowdown, cooling tower blowdown, and the pressed stillage water streams are mixed together. The combined wastewater stream is processed by anaerobic digestion and aerobic digestion to digest organic matter in the stream. Anaerobic digestion produces a biogas stream that is rich in methane so it is fed to the combustor. Aerobic digestion produces a relatively clean water stream that can be reused in the process as well as a sludge that is primarily composed of cell mass. The sludge is also burned in the combustor.

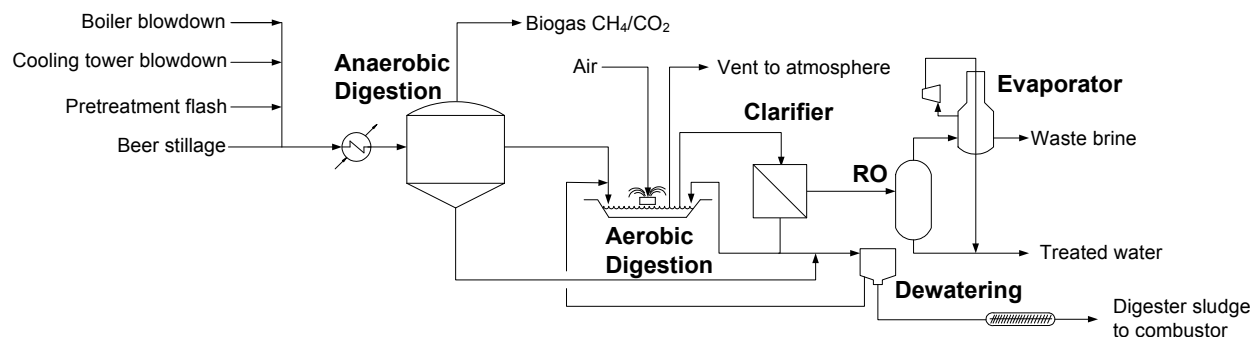

**Figure 13. Simplified flow diagram of the wastewater treatment process**

In previous designs, the stillage from the beer column was evaporated in Area 500 to yield a syrup that could be routed to the combustor, minimizing the loading to WWT in that model. In the present design, this process flow was ruled out because of the switch to ammonia conditioning in Area 200. In the 2002 design, sulfate ions introduced in dilute-acid pretreatment precipitated as gypsum after overliming and were removed from the process. With the switch to ammonia conditioning, the resultant ammonium sulfate and ammonium acetate salts remain in the process and end up in the stillage. When we modeled evaporation of the stillage to syrup, the salt concentrations in the syrup were so high that boiler vendors were not comfortable quoting a combustor system to handle it, due to concerns of burner fouling. We chose, therefore, to eliminate the stillage evaporators and route the stillage to wastewater treatment instead.

While we were confident that anaerobic and aerobic digestion could satisfactorily treat the organic material flowing to WWT in our design, some technology vendors expressed concern with the concentrations of ammonia and sulfate and indicated that these could require special upstream cleanup steps, at additional cost and complexity. In 2010–2011, NREL therefore contracted with Harris Group and Brown and Caldwell (BC) to design a treatment system using actual material generated in the pilot plant. Their testing determined that upstream removal of

sulfur was not required for our process but that nitrification would be required in conjunction with aerobic digestion to handle the ammonia.

The wastewater treatment technology described here deviates significantly from current corn ethanol plants, which strive toward zero-liquid-discharge designs [64]. Such plants may have aerobic digesters or even simple reverse-osmosis systems on internal recycle streams. The deviation in wastewater treatment technology here reflects the challenges inherent in cleaning up inorganics (fertilizer, etc.) that are found on the non-food portion of a food crop and corrosive chemicals added in the front end to overcome lignocellulosic biomass recalcitrance.

### 3.6.2 Design Basis

The wastewater treatment system was designed by Harris Group and Brown and Caldwell under the 2010 subcontract mentioned above. The design includes anaerobic digestion, aerobic digestion with nitrification, sludge dewatering, and reverse osmosis. Additional details can be found in the subcontract report [65]. The relevant design parameters of the wastewater system are summarized in Table 22. Some of these quantities were adjusted from what was determined by laboratory analysis to avoid artificially overdesigning the system for the rich fermentation media components and high suspended solids in the sample.

**Table 22. Wastewater Treatment System Design Basis**

Hydraulic load	2.15 MMgal/d
Wastewater inlet temperature	50°C
Inlet pH	5.2
Total COD	87 g/L
Soluble COD	85 g/L
Total solids	68 g/L
Total suspended solids	1.5 g/L
Total alkalinity	2,750 mg/L as CaCO <sub>3</sub>
Ammonia-N	1,060 mg/L
Total Kjeldahl N	1,200 mg/L
Sulfate	4,400 mg/L
Silica	1,600 mg/L
Potassium	500 mg/L
Phosphate	805 mg/L

Upsets (including unusual suspended solids, fouling, etc.) and other intermittent loads (e.g., from process spills) were not considered in the design. Rain and snow run-off, equipment washing, and other non-process wastewater are assumed to flow to a municipal wastewater treatment system. Insoluble organic compounds like cellulose, xylan, and protein are assumed inert in anaerobic digestion, although these are largely removed upstream in the stillage lignin separator (Area 500). BC indicated that these solid components could be handled in WWT for roughly the same capital cost, but additional operating costs due to nitrification requirements of the protein fraction were prohibitive.

The process flow is detailed in PFD-A120-A601 and PFD-A120-A602 (Appendix E). The pressed stillage water, condensed pretreatment flash vapor, boiler blowdown, and cooling tower blowdown are mixed together and pumped through a heat exchanger (H-602) and cooled to 35°C. The cooled stream then flows directly to the anaerobic digester (T-606).

The total chemical oxygen demand (COD) entering anaerobic digestion in the design case is approximately 26,500 kg/h (58,300 lb/h) (equivalent to 64 g/L). In anaerobic digestion, 91% of each organic component is destroyed; 86% is converted to biogas (methane and carbon dioxide) and 5% is converted to cell mass. Methane is produced from the utilized organic matter at 228 g/kg COD removed. Carbon dioxide is also produced at a nearly equimolar rate to methane, such that the biogas from the digester is 51% CH<sub>4</sub>/49% CO<sub>2</sub> on a dry molar basis. Cell mass is produced at a yield of 45 g cell mass per kg COD digested. Sulfate is converted to hydrogen sulfide (H<sub>2</sub>S) and leaves the system in the biogas. Since the COD-to-sulfate ratio in the design basis is ~20, the methane-producing organisms will out-compete the sulfate-reducing organisms, so upstream removal of sulfate is not necessary.

During standard operation, the biogas will flow to the combustor, providing about 65 MMkcal/h (260 MMBtu/h) or 36% of the total fuel supplied to the combustor. The H<sub>2</sub>S in the biogas will be treated downstream of the combustor with flue gas desulfurization (Area 800). An emergency biogas flare is designed into the process to burn the biogas in case of a process upset in the combustor.

The liquid from the anaerobic digester is pumped to aerobic activated-sludge lagoons with floating aerators (T-608). In the lagoons, 96% of the remaining soluble organic matter is removed, with 74% producing water and carbon dioxide and 22% forming cell mass. With a 91% reduction of the COD in anaerobic digestion followed by a 96% reduction of the remaining COD in aerobic digestion, the total COD reduction is 99.6%. Ammonium ions from the stillage pass through to aerobic digestion where they are converted to nitrate by nitrifying bacteria. Because the nitrification process lowers the pH (by forming nitric acid), caustic must be added to the lagoons for neutralization.

The fully digested material is pumped to a membrane bioreactor (R-609) for clarification. The membrane unit removes additional COD along with colloidal particles (especially silica). Coarse- and ultra-filtration upstream of the membrane unit separate the aerobic biomass sludge. Most of the sludge is recycled to the lagoons to maintain a high cell mass loading. The remaining portion is removed to a holding tank, where it is mixed with sludge from anaerobic digestion.

The sludge in the holding tank is dewatered periodically using a centrifuge (S-611). The centrifuge solid is primarily cell mass and is conveyed to the combustor for disposal (C-614). The water leaving the centrifuge is recycled to the aerobic lagoons for additional treatment.

The treated water has a COD of about 0.5 g/L and is routed to a reverse osmosis (RO) membrane system for salt removal. Approximately 80,000 L/hr (350 gpm) of water is rejected from RO as a 7% brine containing primarily sodium nitrate along with all remaining ions and organics. The RO water effluent is assumed to be pure and is mixed with process makeup water and recycled to the process. The brine from RO is further concentrated in a mechanical-vapor-recompression evaporator (M-640) to 50% solids and the condensate is also recycled to the process. We do not further process the brine in our model at this time, and it is assumed to be waste. In reality, one may choose to further crystallize the brine for solid disposal. Some biomass burners may be designed to handle the salt (turning sodium nitrate into N<sub>2</sub>, NO<sub>x</sub>, and soda ash). It may also be possible to use flue gas to spray-dry this material.

### **3.6.3 Cost Estimation**

Harris Group and Brown and Caldwell estimated cost for the wastewater system, drawing on support from technology vendors such as ADI and Biothane. While the BC estimate included a complete project cost work-up, we have only used the installed equipment costs in our technoeconomic model because we account for our own indirect and project costs at the plant level. To the extent that the cost data obtained by BC were publishable, details can be found in the subcontract report [65]. Harris Group also generated costs for the wastewater cooler (H-602) and sludge screw conveyor (C-614).

### **3.6.4 Wastewater Challenges**

The switch from overliming to ammonia conditioning in Area 200 has forced a major change in our WWT design. In overliming, the sulfate from sulfuric acid pretreatment was removed after conditioning in the form of “gypsum” (calcium sulfate). Previous work showed that this waste product was about 70% gypsum; the rest was unknown organics that could possibly be classified as hazardous waste requiring remediation (e.g., phenolics) [66]. The disposal cost of this material was therefore not well defined in the 2002 model, and ultimately the sugar losses associated with overliming were unacceptable, prompting the switch to ammonia conditioning.

Because the stillage containing ammonium and sulfate salts could no longer be concentrated into a combustible syrup, as noted earlier, the chosen alternative was to route the stillage to wastewater treatment. The ammonia is removed from the system as sodium nitrate (which requires caustic) and the sulfate is removed as gypsum from the combustor flue gas (which requires lime). At this point, readers may question the wisdom of replacing lime in pretreatment with the combined requirement of ammonia in pretreatment, caustic in WWT, and lime in FGD; this is a valid and open question. However, NREL feels that going back to overliming is not the obvious solution, given the cost of hydrolysate solid-liquid separation, uncertainty around the cost of gypsum disposal, and staggering sugar losses associated with overliming. We will investigate how these options affect process economics and sustainability in a future study. The primary research path, as discussed in Sections 3.2 and 3.3, is to reduce the amount of chemicals added in pretreatment and thereby move to so-called no-conditioning processes that may be applicable given the advanced enzymes and fermentation organisms currently in development. This should reduce or eliminate the need for removal of inorganic material from wastewater and bring the plant more in line with current corn ethanol technology.

### 3.7 Area 700: Product and Feed Chemical Storage

#### 3.7.1 Overview

This portion of the plant provides bulk storage for process chemicals and the ethanol product. The chemicals stored in this area include ammonia, corn steep liquor (CSL), sulfuric acid, and gasoline (used as a denaturant for the ethanol product). Water for fire suppression is also stored here.

#### 3.7.2 Design Basis

Table 23 shows the major storage requirements for the present design. PFDs for the storage area can be found in PFD-P120-A701 and PFD-P120-A702 (Appendix E).

**Table 23. Storage Requirements**

<b>Material</b>	<b>Tank No.</b>	<b>Size</b>
Ethanol product	T-701	Sufficient to contain 7 days of production: 2 carbon steel tanks @ 750,000 gal each
Gasoline denaturant	T-710	7 days of blendstock: 1 carbon steel tank @ 65,000 gal
Sulfuric acid (93%)	T-703	5 days of storage: 1 carbon steel tank @ 12,600 gal
Ammonia	T-706	5 days of storage: 2 SA-516-70 tanks @ 28,000 gal. Ammonia is stored anhydrous at 250 psig.
Fire water	T-704	4 hours of fire suppression @ 2,500 gpm: 1 glass-lined carbon steel tank @ 600,000 gal
Corn steep liquor	T-720	5 days of storage: 1 glass-lined carbon steel tank @ 70,000 gal
Diammonium phosphate (DAP)	T-760	7 days of storage: 1 SS304 tank @ 12,800 gal

DAP is assumed to be packaged in super-sacks and is unloaded via solid feeder (C-755), requiring an unloading blower (P-755) and DAP vent baghouse (S-755). From the storage bin, DAP is fed into a day tank (T-760) where it is mixed with water with a 5-hp agitator. The DAP solution is pumped (P-760) to fermentation. The ethanol product pump (P-701), sulfuric acid pump (P-703), ammonia pump (P-706), CSL pump (P-720), and gasoline pump (P-710) are sized for quick loading and unloading of trucks. The fire water pump (P-704) is sized for 2,500 gpm.

#### 3.7.3 Cost Estimation

Harris Group developed costs for most of the equipment in this section using their internal cost database. Quotes for some of the more specialized-material tanks were obtained from Mueller or Trinity Tank (via Chemithon). Quotes for agitators for the DAP and CSL tanks were obtained from Lotus, Inc.

## **3.8 Area 800: Combustor, Boiler, and Turbogenerator**

### **3.8.1 Overview**

The purpose of the combustor, boiler, and turbogenerator subsystem is to burn various organic by-product streams to produce steam and electricity. Combustible by-products include all of the lignin and the unconverted cellulose and hemicellulose from the feedstock, biogas from anaerobic digestion, and biomass sludge from WWT. Burning these by-product streams to generate steam and electricity allows the plant to be self-sufficient in energy (“thermal-neutral”), reduces solid waste disposal costs, and generates additional revenue through sale of excess electricity.

The fuel streams are fed to a combustor capable of handling the wet solids. A fan moves air into the combustion chamber. Treated water enters the heat exchanger circuit in the combustor and is boiled and superheated to high-pressure steam. A multistage turbine and generator are used to generate electricity. Steam is extracted from the turbine at two different conditions for use in the process. In the final stage of the turbine, the remaining steam is taken down to a vacuum and condensed with cooling water for maximum energy conversion. The condensate is returned to the boiler feed water system along with condensate from the various heat exchangers in the process. The steam turbine turns a generator that produces AC electricity for all users in the plant. The balance of electricity is assumed to be sold back to the grid, providing a co-product credit.

### **3.8.2 Design Basis**

The moisture of the combined solid feed to the combustor is 44%; a small amount of additional moisture is entrained in the biogas. Given the fuel disposition, Babcock & Wilcox recommended a TowerPak Stirling Power Boiler system. This system features a live-bottom grated fuel bin to ensure drying and complete combustion of the wet solid fuel. The system was quoted to produce 525,000 lb/h (239,000 kg/h) of steam at 850°F (454°C) and 900 psig. Boiler efficiency, defined as the percentage of the feed heating value that is converted to steam heat, is ~80%.

Flue gas from the combustor preheats the entering combustion air then enters a spray dryer for flue gas desulfurization (FGD). Due to the switch to ammonia conditioning, the sulfur content in the combustor feed is significantly higher than it was in the 2002 design. All of the sulfur entering the combustor is converted to sulfur dioxide, and its concentration in the flue is >1,800 ppmw. This level of SO<sub>2</sub> requires FGD. Lime (calcium hydroxide) is sprayed into the flue gas as a 20 wt % slurry at 20% stoichiometric excess. FGD converts 92% of the SO<sub>2</sub> into calcium sulfate, which falls out the bottom of the spray dryer. The water in the slurry is vaporized and exits with the flue gas to the baghouse. The baghouse removes particulate ash, which is landfilled along with the calcium sulfate. The scrubbed gas is exhausted through a stack.

Pretreatment research is currently targeting a lower acid use, so we will revisit the issue of SO<sub>2</sub> emissions in the future. Additionally, 1% of the generated sulfur dioxide is converted to sulfuric acid. The presence of this acid requires that the flue gas temperature be kept above the dew point to avoid corrosion.

Other pollutant generation rates were not changed from the 2002 design [67] and are computed based on the heating value of the combustion feed stream. Carbon monoxide is assumed to be

generated at a rate of 0.31 kg/MWh (0.2 lb/MMBtu). Nitrogen oxide, or NO<sub>x</sub>, is generated at 0.31 kg/MWh (0.2 lb/MMBtu). NO<sub>x</sub> formation is a complicated mechanism and depends on the feed, combustion temperatures, excess air rate, combustor design, and the presence of flue gas cleanup devices like FGD. The fate of the ammoniated salts in the combustor feed is not well understood, but it is likely that some of the ammonia is converted to nitrous oxide (N<sub>2</sub>O) while also acting to reduce NO<sub>x</sub> formation [68]. (Ammonia injection is indeed one way to reduce NO<sub>x</sub> emissions.)

On the steam side, the boiler feed water (BFW) system includes a softener (M-820) for the makeup and condensate water, a deaerator (T-826) to remove air and other non-condensables, surge tanks, and pumps. Makeup water and condensate are treated and deaerated in these units then preheated with steam to 177°C (351°F). The boiler feedwater pumps (P-826) raise the BFW pressure to 900 psig (62 atm), requiring 540 kW (720 hp) of power. An amine injection system is specified to remove oxygen, which can pit the boiler surfaces. Other boiler chemicals include ammonia, added to control the pH and reduce the corrosive nature of the hot condensate, and phosphate, added to control the formation of scale in the steam drum. Boiler blowdown is 3% of steam production. The blowdown stream is flashed to atmospheric pressure; the vapor is vented to the air and the liquid is routed to wastewater treatment.

The turbogenerator (M-811) uses a multistage turbine with two extraction ports and a final condenser. Of the superheated steam leaving the boiler, 12% is extracted from the turbine at 175 psig (13 atm) and 268°C (514°F) for feeding to the pretreatment reactor and the BFW economizer. An additional 35% is extracted at 125 psig (9.5 atm) and 164°C (327°F) and is used in distillation and in the deaerator. The rest of the steam is condensed at -13 psig (0.1 atm). The condensate is pumped back to the boiler. The turbine shaft turns a generator to produce electricity. The generator efficiency is assumed to be 85%. For this design, a total of 41 MW of power is generated from the system. The process uses 28 MW, leaving about 13 MW to be sold to the grid.

### **3.8.3 Cost Estimation**

Harris Group investigated the combined system of combustor, boiler, and turbogenerator. They contacted several vendors to obtain cost and operating information to identify a system suitable for the available fuel streams and steam requirements. The combustor/boiler quote ultimately came from Babcock & Wilcox and included the BFW preheater, FGD spray dryer, and baghouse. For the baghouse, bag replacement appears as a periodic charge in the cash flow worksheet.

The turbogenerator is essentially an off-the-shelf technology, and Harris Group obtained a quote for a 42.2 MW Siemens generator suitable for this project. Harris Group also obtained quotes from Proctor Sales for support equipment including the deaerator, chemical injection system, tanks, and pumps.

## 3.9 Area 900: Utilities

### 3.9.1 Overview

Area 900 is used to track the utilities required by the ethanol production facility (except for steam, which is provided by Area 800). Area 900 tracks cooling water, chilled water, plant and instrument air, process water, and the clean-in-place (CIP) system. Area 900 also tracks the electricity usage throughout the plant.

The process water manifold in Area 900 mixes fresh water with treated wastewater (assumed suitable for all plant users) and provides this water at a constant pressure to the facility. Water is provided to the cellulase production unit, boiler and cooling tower makeup, the CIP system, and the vent scrubber. Fresh water is also mixed with some internally-recycled water for dilution before pretreatment and enzymatic hydrolysis. The plant and instrument air systems provide compressed air for general use (pneumatic tools and clean-up) and instrument operation. Larger users of compressed air, namely the stillage filter press and cellulase system, have their own compressors specified. The CIP system provides hot cleaning and sterilization chemicals to hydrolysis and fermentation, the enzyme production section, and the distillation system.

### 3.9.2 Design Basis

The cooling water system is designed for a 28°C supply temperature with a 9°C temperature rise in coolers throughout the facility. This is an assumed average rise; the actual cooling water rises across each exchanger are not explicitly modeled in Aspen. The primary cooling water users in this process are listed in Table 24. The percentage of cooling duty contributed by each user is shown in Figure 14.

**Table 24. Cooling Water Users**

M-811	Condenses the steam turbine exhaust at a vacuum.
M-908	The chilled-water loop requires cooling water to condense the refrigerant. The cooling water duty to M-908 is set equal to the total load on the chilled-water loop.
H-301	Cools the pretreated slurry to enzymatic hydrolysis temperature (48°C).
H-509	Cools the ethanol product leaving the molecular sieve before it enters storage.
F-300	Before fermentation is initiated, the slurry must be cooled to fermentation temperature. It is assumed that cooling water would be used for the initial drop from 48°C to 35°C and that chilled water would afterward be substituted to sustain this temperature.
H-503	Provides cooling and condensation during regeneration of the molecular sieve.
M-401	Uses cooling water to cool the compressed air used in enzyme production.
H-504	Condenses the beer column reflux.
H-244	Condenses residual pretreatment flash vapor before it enters WWT. Most of the vapor is condensed by heat exchange with the incoming dilution water and boiler feed water.



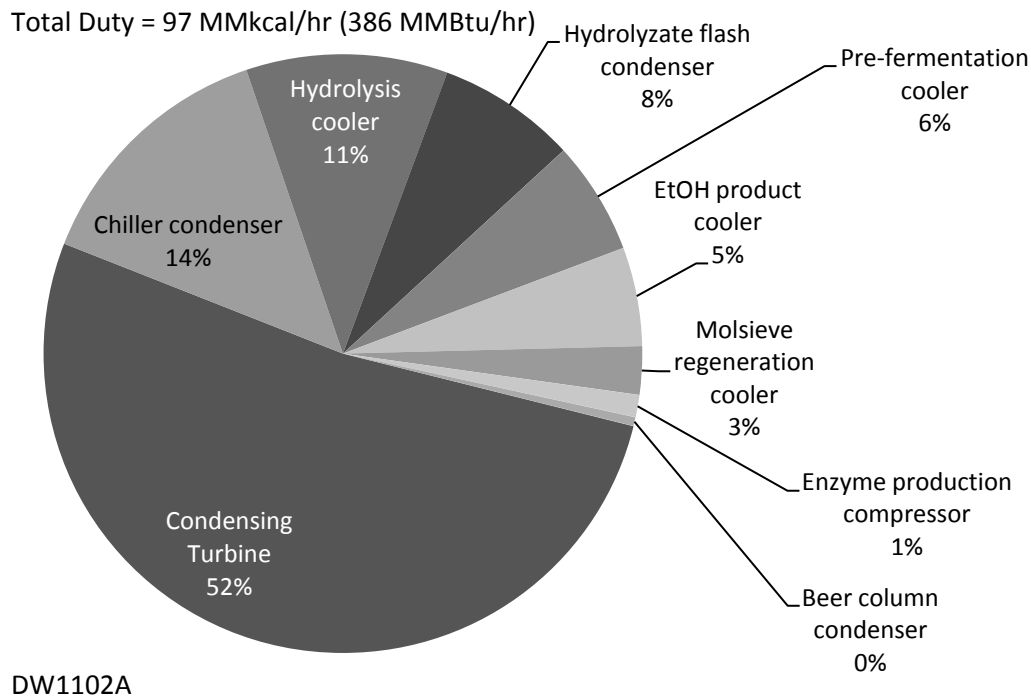

**Figure 14. Cooling duty distribution between major users**

By far the biggest user of cooling water is the condensing turbine. In contrast to the 2002 design, the cooling water duty required by the ethanol separation section is relatively small because an air-cooled condenser was specified for the rectification column. Aspen computes the cooling tower evaporation rate based on a temperature drop from 37°C to 28°C. It was assumed that windage would be 0.005% of the total flow to the tower. The tower blowdown was assumed to be 0.15% of the flow leaving the tower basin.

Chilled water is provided by two 2,350-ton Trane centrifugal chillers. Per the chiller spec sheet, the compressor electricity demand for the chiller was estimated at 0.56 kW/ton of refrigeration. The cooling water demand for the chiller system was assumed to be equal to the heat removed in the chilled-water loop. The chilled-water loop provides cooling to the fermentors in Area 300 and Area 400.

Fresh water is assumed to enter the facility at 13°C and is used to cool the wastewater entering Area 600 to digestion temperature before entering the process water tank. The fresh water is mixed with the treated wastewater effluent in the process water tank (T-914) and then split several ways. Clean water must be provided to biomass dilution in the front end, to the cellulase production unit, to the vent scrubber, and to the boiler and cooling tower water makeup. The process water tank is designed for an 8-hour residence time. The process water pump (P-914) pumps water from the tank into the facility and is designed to handle 1.5x the process water flow requirement. In the present design, less water is recycled internally in the process than in the

2002 design. The only water stream directly recycled to the front end of the process is the rectification column bottoms.

The plant and instrument air systems provide compressed air for pneumatic tools and clean-up and instrument operation. The plant air compressor is sized for 400 SCFM at 125 psig. An instrument air dryer and surge tank were designed to provide clean dry air at a consistent pressure to the instrument air system. The surge tank was sized at 3,800 gal.

About 68% of the electricity generated by the boiler in Area 800 is used throughout the plant to power pumps, agitators, compressors, etc. The surplus is sold to the grid for credit. The distribution of total plant power utilization among all areas is shown in Figure 15. Note that the cost of the power required by Area 100 is already assumed to be included in the feedstock cost but must be subtracted from the plant's electricity export. This is reflected in the economics by an operating cost credit equal to this amount of electricity.

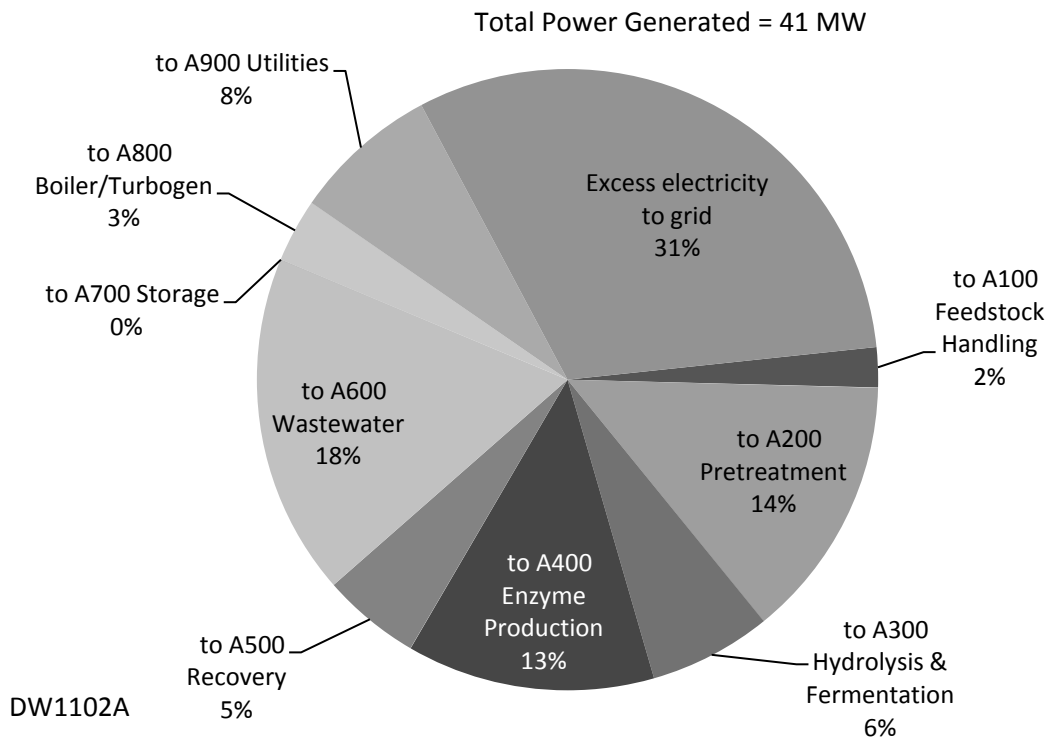

Figure 15. Distribution of plant electricity utilization by process area

### 3.9.3 Cost Estimation

The cooling tower was based on a cost estimate from Marley SPX for a fiberglass cooling tower capable of handling 44,000 gpm. Harris Group estimated costs for the cooling water circulation and makeup pumps using their internal database. The material of construction for the cooling water loop is carbon steel. The cost for the chiller came from a recent Trane quote for a similarly-sized system. Harris Group also used their internal database to estimate costs for the remaining equipment: the process water tank and pump; the plant/instrument air compressor, dryer, and surge tank; and the CIP system.

## 4 Process Economics

The ultimate purpose for developing such a detailed process design, simulation model, and cost estimate is to determine the economics of ethanol production. This information is used either as an absolute cost to assess ethanol's potential in the marketplace or as a relative cost that can be used to guide research by examining the change in production cost associated with a process modification or other core research activity.

The total capital investment (TCI) is first computed from the total equipment cost. Next, variable and fixed operating costs are determined. With these costs, we use a discounted cash flow analysis to determine the minimum ethanol selling price (MESP) required to obtain a zero net present value (NPV) with a finite internal rate of return (IRR). This section describes the assumptions made in completing the discounted cash flow analysis.

Our analysis does not take into account any policy factors such as subsidies, mandates, or carbon credits because these would be purely speculative. The purpose of this analysis is to demonstrate whether or not cellulosic ethanol can be cost-competitive on its own merits and, if it cannot, to give policymakers a sense of the magnitude of incentive required to make it so.

### 4.1 About Cost-Year Indices

The cost-year of 2007 was chosen for this analysis to align with DOE's 2012 cellulosic ethanol performance cost goals [27]. It is expected that these performance goals will remain in 2007 dollars (2007\$) through 2017 to permit comparison of future feedstocks, conversion technologies, and cellulosic biofuels. However, the present equipment costs were obtained in 2009\$ or 2010\$ and cost-years for chemicals range from 1999 to 2010. The following is a brief discussion of the methods used for determining MESP in another year's dollar value.

Each piece of equipment has a purchased cost that reflects a quote made in a certain year. Capital costs provided by Harris Group in 2009\$ or 2010\$ were adjusted using the Plant Cost Index from *Chemical Engineering Magazine* [69] to a common basis year of 2007. The final cost index for a given year is generally not made available until the spring of the following year. Therefore, for the small number of equipment items that were quoted in 2010\$, we used the Plant Cost Index value from August of 2010. Similarly, for chemical costs we used the Industrial Inorganic Chemical Index from SRI Consulting [70]. Employee salaries were obtained in 2009\$ and were scaled using the labor indices provided by the United States Department of Labor Bureau of Labor Statistics [71]. The general formula for year-dollar back-casting is:

$$2007 \text{ Cost} = (\text{Base Cost}) \left( \frac{2007 \text{ Cost Index}}{\text{Base Year Index}} \right)$$

The cost indices for capital and chemicals are not duplicated here; however, the reader is probably aware of the significant run-up in the price of raw materials such as steel and petroleum in the second half of the 2000s, beginning in 2003–2004. This inflation had dramatic effects on the prices of equipment and chemicals used in our design. Following a market correction, the Plant Cost Index crested in 2008, with the 2009 index actually being lower than the 2007 index. The Industrial Inorganic Chemical Index also crested in 2008 but the correction in 2009 was much smaller. In the year 2007 in particular, chemical prices varied wildly month-to-month and

location-to-location, depending on the available supply. It should be noted, therefore, that the chemical costs used in this analysis are static back-projections based on these cost indices. While these costs are reported in 2007\$, they do not necessarily reflect the actual market price of that chemical in 2007.

The electricity export price was taken to be the average wholesale price as determined by the North American Electric Reliability Corporation for a given year. The wholesale price applies to electricity that is credited back to the grid. These data are provided on the Energy Information Administration's website [72]. For 2007, the wholesale electricity price was 5.71675 cents/kWh.

## **4.2 Total Capital Investment (TCI)**

Section 3 of this report describes the details of the conceptual process design and how the purchased cost of the equipment was determined. The next step is to determine the installed cost of that equipment. The installation cost can be determined by performing a detailed study of everything required to install the necessary equipment and make it operational (e.g., foundation, piping, wiring). This type of detail is not warranted at this level of analysis, and a factored approach in which multipliers are applied to the purchased equipment cost is considered satisfactory. Many engineering texts such as Garrett [73] or Peters and Timmerhaus [74] detail such factored methodologies for common chemical processes. Indeed, there are as many methodologies for computing the total installed cost of capital equipment as there are textbooks on plant economics. The matter of which method is "correct" is of course open for debate; however, at this level of detail, each methodology is generally considered as good as the next.

The overarching cost methodology we have followed comes from the first biochemical design report prepared for NREL by Chem Systems in 1994 [75]. They provided installation factors for individual pieces of equipment, taken from Walas [76]. While simpler methods suggest a single multiplier be applied to the total purchased equipment cost, those methods tend to cite multipliers applicable for very large projects comprising mostly carbon steel equipment. For the relatively small plant described here, with mixed carbon and stainless steel equipment, the individual installation factor method makes more sense.

From the 1994 Chem Systems report, some of the installation factors were modified in the 1999 and 2002 design reports based on the experience of the engineers involved. Because the costs for the present design were all new, we chose to revert all installation factors back to the values specified by Walas. We found, however, that the Walas factors were in turn taken from the methodology of Cran [77], who deliberately excluded instrumentation costs from his installation factors so that these could be estimated separately. Although Cran details how to compute instrument costs, we decided to assume these would be 30% of the purchased equipment cost, consistent with the estimate in Peters and Timmerhaus [74], which we imposed by adding 0.3 to the Cran factors.

The list of installation factors for the various pieces of equipment is shown in Table 25. See Appendix A for a complete listing of the equipment, along with its purchased and installed costs. In contrast to the 2002 design, which had an equipment cost for every single item, Harris Group obtained many package quotes, in which a given unit operation and all of its support equipment were quoted under one price. The installation factor for such packages can be relatively low because most of the engineering is already included in the price. Additionally, equipment

designed as a pre-fabricated skid generally has a lower construction cost. Also, components that are more highly machined and have higher-quality metallurgy tend to be more expensive per unit mass and therefore have a lower installation factor as a function of purchase price than a less sophisticated component does. A good example of all three of these considerations is the pretreatment reactor system.

**Table 25. Installation Factors**

<b>Equipment</b>	<b>Multiplier<sup>a</sup></b>
Agitators, carbon steel	1.6
Agitators, stainless steel	1.5
Boiler	1.8
Compressors, motor driven	1.6
Cooling tower	1.5
Distillation columns, stainless steel	2.4
Heat exchangers, shell & tube, stainless steel	2.2
Heat exchangers, plate & frame, stainless steel	1.8
Heat exchangers, air-cooled	2.8
Inline mixers	1.0
Skidded equipment	1.8
Solids handling equipment (incl. filters)	1.7
Pressure vessels, carbon steel	3.1
Pressure vessels, stainless steel	2.0
Pretreatment reactor system	1.5
Pumps, stainless steel	2.3
Pumps, carbon steel	3.1
Tanks, field-erected, carbon steel	1.7
Tanks, field-erected, stainless steel	1.5
Tanks, storage, plastic	3.0
Tanks, storage, carbon steel	2.6
Tanks, storage, stainless steel	1.8
Turbogenerator	1.8

<sup>a</sup> Installed cost = (purchased equipment cost) x (multiplier).

The purchased cost for a given component reflects a baseline equipment size. As changes are made to the process, the equipment size required may be different than what was originally designed. Instead of re-costing in detail, an exponential scaling expression was used:

$$\text{New Cost} = (\text{Base Cost}) \left( \frac{\text{New Size}}{\text{Base Size}} \right)^n$$

where  $n$  is a characteristic scaling exponent (typically in the range of 0.6 to 0.7) based upon some characteristic of the equipment related to production capacity, such as flow or heat duty. Such scaled costs are easier to calculate and generally give nearly the same result as resizing the equipment for each scenario. The scaling exponent can be inferred from vendor quotes if multiple quotes are given for different sizes, computed with costing software, or obtained from a standard reference [73–74, 76]. In our case, we returned to the exponents proposed in the 1994 Chem Systems report, which are shown in Table 26. Note that because the costs for most equipment items were newly estimated at their size in the present design, the exponents do not greatly affect the base MESP. They only factor into the calculation when changes are made in the process.

**Table 26. Scaling Exponents**

<b>Equipment</b>	<b>Exponent</b>
Agitators	0.5
Compressors, motor driven	0.6
Distillation columns	0.6
Heat exchangers	0.7
Inline mixers	0.5
Package quotes / Skidded equipment	0.6
Pressure vessels	0.7
Pumps	0.8
Tanks, atmospheric	0.7
Solids handling equipment	0.8

Once the total equipment cost has been determined in the year of interest, we must add several other direct and indirect costs to determine the total capital investment (TCI). Site development and warehouse costs are based on the inside-battery-limits (ISBL) equipment costs (Areas 200, 300, 400, and 500) and are considered part of the total direct cost (TDC). Project contingency, field expenses, home-office engineering and construction activities, and other costs related to construction are computed relative to the TDC and give the fixed capital investment (FCI) when summed. The sum of FCI and the working capital for the project is the TCI. Table 27 summarizes these categories and additional factors. Harris Group reviewed the items and factors and determined that they were consistent with other projects the company has completed. Harris Group thought the “home office and construction” charge used in 2002 was possibly a bit high at 25%, so this was reduced to 20%. The project contingency was also changed from 3% to 10% of the TDC. Table 28 summarizes the total installed equipment cost and illustrates the application of factors in Table 27 to obtain the total capital investment (TCI).

**Table 27. Additional Costs for Determining Total Capital Investment (TCI)**

<b>Item</b>	<b>Description</b>	<b>Amount</b>
<b>Additional direct costs</b>		
Warehouse	On-site storage of equipment and supplies.	4.0% of the installed cost of ISBL equipment (A200,300,400,500)
Site development	Includes fencing, curbing, parking lot, roads, well drainage, rail system, soil borings, and general paving. This factor allows for minimum site development assuming a clear site with no unusual problems such as right-of-way, difficult land clearing, or unusual environmental problems.	9% of ISBL
Additional piping	To connect ISBL equipment to storage and utilities outside the battery limits.	4.5% of ISBL
<b>Indirect costs</b>		
Prorateable costs	This includes fringe benefits, burdens, and insurance of the construction contractor.	10% of total direct cost (TDC)
Field expenses	Consumables, small tool and equipment rental, field services, temporary construction facilities, and field construction supervision.	10% of TDC
Home office and construction	Engineering plus incidentals, purchasing, and construction.	20% of TDC
Project contingency	Extra cash on hand for unforeseen issues during construction.	10% of TDC
Other costs	Start-up and commissioning costs. Land, rights-of-way, permits, surveys, and fees. Piling, soil compaction/dewatering, unusual foundations. Sales, use, and other taxes. Freight, insurance in transit, and import duties on equipment, piping, steel, instrumentation, etc. Overtime pay during construction. Field insurance. Project team. Transportation equipment, bulk shipping containers, plant vehicles, etc.	10% of TDC

**Table 28. Project Cost Worksheet Including Total Direct Costs and Total Capital Investment**

<b>Process Area</b>		<b>Purchased Cost</b>	<b>Installed Cost</b>
Area 100: Feedstock handling <sup>a</sup>		\$ 14,200,000	\$ 24,200,000
Area 200: Pretreatment		\$ 19,900,000	\$ 29,900,000
Area 200: Conditioning		\$ 1,500,000	\$ 3,000,000
Area 300: Enzymatic hydrolysis and fermentation		\$ 18,500,000	\$ 31,200,000
Area 400: Enzyme production		\$ 10,700,000	\$ 18,300,000
Area 500: Recovery		\$ 11,100,000	\$ 22,300,000
Area 600: Wastewater		\$ 49,300,000	\$ 49,400,000
Area 700: Storage		\$ 2,800,000	\$ 5,000,000
Area 800: Boiler		\$ 36,500,000	\$ 66,000,000
Area 900: Utilities		\$ 4,000,000	\$ 6,900,000
<b>Totals (excl. Area 100)</b>		<b>\$ 154,500,000</b>	<b>\$ 232,100,000</b>
Warehouse	4.0%	of ISBL	\$ 4,200,000
Site development	9.0%	of ISBL	\$ 9,400,000
Additional piping	4.5%	of ISBL	\$ 4,700,000
<b>Total Direct Costs (TDC)</b>			<b>\$ 250,400,000</b>
Prorateable expenses	10.0%	of TDC	\$ 25,000,000
Field expenses	10.0%	of TDC	\$ 25,000,000
Home office & construction fee	20.0%	of TDC	\$ 50,100,000
Project contingency	10.0%	of TDC	\$ 25,000,000
Other costs (start-up, permits, etc.)	10.0%	of TDC	\$ 25,000,000
<b>Total Indirect Costs</b>			<b>\$ 150,200,000</b>
<b>Fixed Capital Investment (FCI)</b>			<b>\$ 400,600,000</b>
Land			\$ 1,800,000
Working capital	5.0%	of FCI	\$ 20,000,000
<b>Total Capital Investment (TCI)</b>			<b>\$ 422,500,000</b>
Lang Factor (FCI/purchased equip cost) <sup>b</sup>			3.1
TCI per annual gallon 2007 dollars			\$6.92/gal

DW1102A

<sup>a</sup> Feedstock handling not included in this calculation.

<sup>b</sup> Area 600 not included in Lang Factor.

### 4.3 Variable Operating Costs

Variable operating costs, which include raw materials, waste handling charges, and by-product credits, are incurred only when the process is operating. Quantities of raw materials used and wastes produced were determined using the Aspen material balance. Table 29 documents the costs and sources of chemicals used in the process, and Table 30 summarizes the variable costs on a per-year and per-gallon-of-ethanol basis.



**Table 29. Chemical Costs and Sources**

<b>Component</b>	<b>Cost (2007\$)</b>	<b>Source</b>
Feedstock (corn stover)	\$0.0224/lb	MYPP, \$58.50/dry ton @ 20% moisture [27]
Sulfuric acid, 93%	\$0.0399/lb	Basic Chemical of Omaha via Harris Group
Ammonia	\$0.1993/lb	Terra Industries via Harris Group
Corn steep liquor	\$0.0252/lb	Corn Products via Harris Group
Diammonium phosphate	\$0.4385/lb	Ronas Chemicals via Harris Group
Sorbitol	\$0.5005/lb	Coast Southwest via Harris Group
Glucose	\$0.2579/lb	USDA ERS [78]
SO <sub>2</sub>	\$0.1378/lb	SRI Chemical Economics Handbook (CEH)
Enzyme nutrients	\$0.3727/lb	SRI CEH (See Table 20)
Caustic	\$0.0678/lb	Brown and Caldwell WWT design [65]
Lime	\$0.0904/lb	Harris Group
Boiler chemicals	\$2.2661/lb	2002 Design Report [2]
Cooling tower chemicals	\$1.3580/lb	2002 Design Report [2]
Fresh water	\$0.0001/lb	Peters & Timmerhaus [74]

**Table 30. Variable Operating Costs**

<b>Process Area</b>	<b>Stream Description</b>	<b>Usage (kg/h)</b>	<b>Usage (lb/h)</b>	<b>Cost (\$/ton)</b>	<b>\$/hour</b>	<b>MM\$/yr (2007\$)</b>	<b>Cent/Gal Ethanol (2007\$)</b>
<b>Raw materials</b>							
N/A	Feedstock (wet)	104,167	229,688	46.80	5,374.69	45.20	74.07
A200	Sulfuric acid, 93%	1,981	4,367	81.39	177.73	1.49	2.45
	Ammonia	1,051	2,317	406.96	471.48	3.97	6.50
A300	Corn steep liquor	1,158	2,554	51.55	65.84	0.55	0.91
	Diammonium phosphate	142	313	895.32	140.33	1.18	1.94
	Sorbitol	44	98	1,021.93	49.96	0.42	0.69
A400	Glucose	2,418	5,332	526.52	1,403.60	11.80	19.34
	Corn steep liquor	164	363	51.55	9.35	0.08	0.13
	Ammonia	115	254	406.96	51.59	0.43	0.71
	Host nutrients	67	149	745.30	55.34	0.47	0.76
	Sulfur dioxide	16	36	275.70	4.99	0.04	0.07
A600	Caustic	2,252	4,966	135.65	336.83	2.83	4.64
A800	Boiler chems	<1	1	4,532.17	1.23	0.01	0.02
	FGD lime	895	1,973	180.87	178.42	1.50	2.46
A900	Cooling tower chems	2	5	2,716.10	7.14	0.06	0.10
	Makeup water	147,140	324,443	0.23	38.11	0.32	0.53
	<b>Subtotal</b>				<b>8,328.49</b>	<b>70.36</b>	<b>115.30</b>
<b>Waste disposal</b>							
A800	Disposal of ash	5,725	12,623	28.86	182.15	1.53	2.51
	<b>Subtotal</b>				<b>182.15</b>	<b>1.53</b>	<b>2.51</b>
<b>By-products and credits</b>							
	Grid electricity	12,797	kW	\$0.0572/kWh	731.57	6.15	10.08
	Area 100 electricity	859	kW	\$0.0572/kWh	49.13	0.41	0.68
	<b>Subtotal</b>				<b>780.71</b>	<b>6.57</b>	<b>10.76</b>
<b>Total variable operating costs</b>					<b>7,779.08</b>	<b>65.33</b>	<b>107.76</b>

#### 4.4 Fixed Operating Costs

Fixed operating costs are generally incurred in full whether or not the plant is producing at full capacity. These costs include labor and various overhead items. Many of the assumptions on fixed operating costs follow the 2002 design report [2] and/or Peters and Timmerhaus [74].

Table 31 shows the recommended number of employees and associated salaries. The number of employees was estimated by considering the likely degree of automation for each area and adding a reasonable number of management and support employees. The total number of employees has been reduced from 77 in the 2002 design to 60. The major reason for the reduced labor requirement is the redesign of the feed handling area. In the present design, feedstock is received year-round according to uniform-format specifications and is unloaded with truck tippers, eliminating the need for yard employees and operators to perform milling and washing. Eight operators and two laboratory technicians were added to support the on-site enzyme section, but overall fewer employees were required. Excluding these 10 employees, 50 employees for the ethanol facility is also consistent with a 2008 LECG consulting report prepared for the Renewable Fuels Association [79]. Salaries were estimated by using commercially available salary estimators such as Salary.com as well as open positions posted on internet job sites. Because the model feedstock is corn stover, salaries were estimated for rural regions of the U.S. Midwest (Iowa, Missouri, etc.). These estimates may vary depending on location.

**Table 31. Fixed Operating Costs**

<b>Position</b>	<b>2007 Salary</b>	<b># Required</b>	<b>2007 Cost</b>	<b>MM\$/yr (2007\$)</b>	<b>Cent/Gal Ethanol (2007\$)</b>
<b>Labor and supervision</b>					
Plant manager	141,569	1	141,569		
Plant engineer	67,414	2	134,828		
Maintenance supervisor	54,894	1	54,894		
Maintenance technician	38,522	12	462,266		
Lab manager	53,931	1	53,931		
Lab technician	38,522	2	77,044		
Lab tech-enzyme	38,771	2	77,044		
Shift supervisor	46,227	4	184,906		
Shift operators	38,522	20	770,443		
Shift oper-enzyme	38,771	8	308,177		
Yard employees	26,966	4	107,862		
Clerks and secretaries	34,670	3	104,010		
Total salaries			2,500,000	2.48	4.06
Labor burden (90%)			2,200,000	2.23	3.65
<b>Other overhead</b>					
Maintenance	3.0%	of ISBL	3,200,000	3.14	5.15
Property insurance	0.7%	of FCI	2,700,000	2.80	4.60
<b>Total fixed operating costs</b>				<b>10.66</b>	<b>17.46</b>

A 90% labor burden is applied to the salary total and covers items such as safety, general engineering, general plant maintenance, payroll overhead (including benefits), plant security, janitorial and similar services, phone, light, heat, and plant communications. The 90% estimate is the median of the general overhead range suggested in the 2008 PEP Yearbook produced by SRI Consulting [80].

Annual maintenance materials were estimated as 3% of the installed ISBL capital cost and property insurance and local property tax were estimated as 0.7% of the fixed capital investment, based on the 1994 Chem Systems report [75].

#### **4.5 Discounted Cash Flow Analysis and the Minimum Selling Price of Ethanol**

Once the total capital investment, variable operating costs, and fixed operating costs have been determined, a discounted cash flow rate of return (DCFROR) analysis can be used to determine the minimum selling price per gallon of ethanol produced. The discounted cash flow analysis is calculated by iterating the selling cost of ethanol until the net present value of the project is zero. This analysis requires that the discount rate, depreciation method, income tax rates, plant life, and construction start-up duration be specified. Because this plant is equity-financed, some assumptions about the loan terms are also required.

We stress that the financial assumptions detailed in this section are of course subject to uncertainty and are not intended to represent the final word in project management. For research and policy purposes, one must at some point decouple the cost of making ethanol from the cost of making money. These financial parameters serve merely as a reference point from which to examine other economic sensitivities.

##### *Discount Rate*

For this analysis, the discount rate (which is also the internal rate of return [IRR] in this analysis) was set to 10% and the plant lifetime was set to 30 years. The discount rate was also used in previous design reports and was based on the recommendation in Short et al. [81] on how to perform economic evaluations of renewable energy technologies for DOE. His view was that, “In the absence of statistical data on discount rates used by industrial, transportation and commercial investors for investments with risks similar to those of conservation and renewable energy investments, it is recommended that an after tax discount rate of 10%...be used.”

##### *Equity Financing*

For this analysis, it was assumed that the plant would be 40% equity financed. The terms of the loan were taken to be 8% interest for 10 years. The principal is taken out in stages over the 3-year construction period. Interest on the loan is paid during this period, but principal is not paid back. (This is another  $n^{\text{th}}$ -plant assumption, which says that this cash flow comes from the parent company until the plant starts up.) This is all in contrast to the 2002 design, which assumed a 100% equity purchase. Figure 16 illustrates the sensitivity of minimum ethanol selling price to the percentage of equity financing and the after-tax discount rate (the IRR).

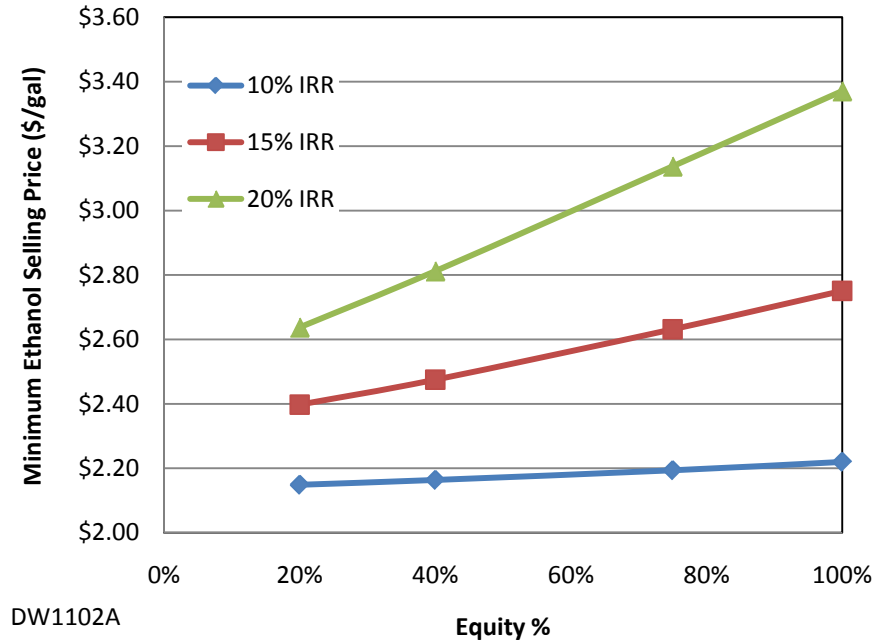

**Figure 16. Sensitivity of MESP to IRR and % equity (8% interest on a 10-year loan)**

*Depreciation*

To determine the capital depreciation amount for the calculation of federal taxes to be paid we used the IRS Modified Accelerated Cost Recovery System (MACRS). Within the MACRS system is the General Depreciation System (GDS), which allows both the 200% and 150% declining balance (DB) methods of depreciation. This offers the shortest recovery period and the largest tax deductions. According to IRS publication 946 [82], a cellulosic ethanol plant would fall under Asset Class 49.5, “Waste Reduction and Resource Recovery Plants.” This class uses a 7-year recovery period, not including the steam plant equipment, which has a 20-year recovery period (Asset Class 49.13). IRS publication 946 contains a special provision for cellulosic biofuels plants that allows them to write off 50% of the capital investment in the first year. This was not implemented in our cost model because it does not ultimately affect the MESP. (Although the provision affects the cash flow in the first few years of the analysis, it does not change the year in which the plant goes into the black and must start paying taxes.)

*Taxes*

The federal corporate tax rate used in our analysis is 35%. Income tax is averaged over the plant life and that average is calculated on a per-gallon basis. The amount of income tax to be paid by a potential ethanol producer varies annually due to changes in the volume of product produced and the allowable depreciation deduction. In fact, no income tax is paid in the first eight years of operation because the depreciation and loan interest deductions are greater than the net income. State taxes are not considered, primarily because the location of the plant has not been determined and tax rates vary from state to state (from 0% to 12%).

*Construction Time*

The construction time is important to the cash flow analysis because no income is earned during construction, but huge sums of money are being expended. Perry and Green [83] indicate that

small projects (less than \$10 million investment) can be constructed in fewer than 18 months and that larger projects can take up to 42 months. An overview of petroleum refining economics indicates that large refineries (on the order of \$1.5 billion investment) can be constructed in 24 months [84]. Certainly this ethanol process is much smaller than a petroleum refinery, so using a construction time of 24 months fits within these references, although an important difference between this type of facility and a refinery is the large number of field-erected vessels. These are constructed on-site and have a longer construction time than if the tanks were delivered finished. Table 32 summarizes the schedule for construction and the cash flow during that time. Twelve months are added before construction for planning and engineering.

**Table 32. Construction Activities and Cash Flow**

<b>Project Start Month</b>	<b>Project End Month</b>	<b>Activity Description</b>	<b>% of Project Cost</b>
0	12	Project plan and schedule established; conceptual and basic design engineering, permitting completed. Major equipment bid packages issued, engineering started on selected sub-packages, P&IDs complete, preliminary plant and equipment arrangements complete.	8%
12	24	All detailed engineering including foundations, structure, piping, electrical, site, etc. complete; all equipment and instrument components purchased and delivered; all site grading, drainage, sewers, rail, fire pond, foundation, and major structural installation complete; 80% of all major process equipment set (all except longest-lead items), all field fabricated tanks built, and the majority of piping and electrical materials procured.	60%
24	36	Complete process equipment setting, piping, and instrumentation installation complete; all electrical wiring complete; all building finishing and plumbing complete; all landscaping complete; pre-commissioning complete; and commissioning, start-up, and initial performance test complete.	32%
<b>TOTAL</b>			<b>100%</b>

Note: The above assumes no utility or process equipment orders placed prior to month seven. Expenditures based on typical 60 MMgal/yr grain-to-ethanol facility.

### *Start-Up Time*

Perry and Green [83] indicate that for a moderately complex plant, start-up should be about 25% of the construction time, or 6 months in this case. Delta-T's experience (described in the 2002 design report) with start-up indicated that a large grain-to-ethanol plant could be started up in less than 6 months. Considering that this design is for the  $n^{\text{th}}$  operating plant, we assumed a start-up time of 3 months. The start-up period is not completely wasted, however. We expect that an average of 50% production could be achieved during that period while incurring 75% of variable expenses and 100% of fixed expenses.

### *Working Capital*

Peters and Timmerhaus [74] define working capital as money available to cover (1) raw materials and supplies in inventory, (2) finished product in storage, (3) accounts receivable, (4) cash on hand for monthly payments such as wages and maintenance supplies, (5) accounts payable, and (6) taxes payable. They indicate that working capital is usually 10%–20% of the fixed capital investment. This flow of money is required over the life of the plant, beginning in

the start-up phase to make product that generates revenue to use in purchasing more materials and supplies. For this project, 10% would be about \$40 million. On-site ethanol storage capacity is 7 days; assuming that the product can be made, shipped, and payment received in 30 days is conservative. One month's raw materials, labor, maintenance, taxes, and overhead is \$6.9 million. Therefore, a lower number seems reasonable. Garrett [73] suggests that using a fraction of the yearly operating cost, typically 10%–35%, is more relevant. When these percentages are used to calculate working capital, this results in a working capital range of \$8 million–\$28 million. We chose to use \$20 million, or 5% of the fixed capital investment.

Table 33 summarizes the parameters used in the discounted cash flow analysis. Using these parameters, plus the cost information in Table 28, Table 30, and Table 31, the resulting minimum ethanol selling price of pure ethanol is \$2.15/gal (2007\$). Table 34 summarizes the yields and conversion costs for the present design. According to the methodology of Cran [77], the expected accuracy of the TCI analysis is +/- 25%. If we apply this uncertainty to the TCI, the impact on the cost of ethanol is +/- \$0.24/gal. The complete discounted cash flow summary worksheet is shown in Appendix B. The MESP can be further broken down into the cost of each process area. Figure 17 illustrates the contribution to the overall cost by process area and capital, operations, and fixed costs. (The bar for feedstock + handling reflects the single feedstock cost of \$58.50/dry U.S. ton delivered to pretreatment and has not been decomposed.)

**Table 33. Discounted Cash Flow Analysis Parameters**

Plant life	30 years
Discount rate	10%
General plant depreciation	200% declining balance (DB)
General plant recovery period	7 years
Steam plant depreciation	150% DB
Steam plant recovery period	20 years
Federal tax rate	35%
Financing	40% equity
Loan terms	10-year loan at 8% APR
Construction period	3 years
First 12 months' expenditures	8%
Next 12 months' expenditures	60%
Last 12 months' expenditures	32%
Working capital	5% of fixed capital investment
Start-up time	3 months
Revenues during start-up	50%
Variable costs incurred during start-up	75%
Fixed costs incurred during start-up	100%

**Table 34. Summary of Yields, Rates, and Conversion Costs**

Feedstock rate	2,205 dry U.S. ton/day
On-line time	8,410 h/yr
Ethanol yield	79.0 gal/dry U.S. ton feedstock (76% theoretical based on feedstock carbohydrates)
Ethanol production rate	61.0 MMgal/yr
Total equipment cost	\$232MM
Total capital investment (TCI)	\$423MM
TCI per annual gallon	\$6.92/gal
<b>Minimum Ethanol Selling Price</b>	<b>\$2.15/gal</b>
Feedstock contribution	\$0.74/gal
Enzyme contribution	\$0.34/gal
Non-enzyme conversion contribution	\$1.07/gal

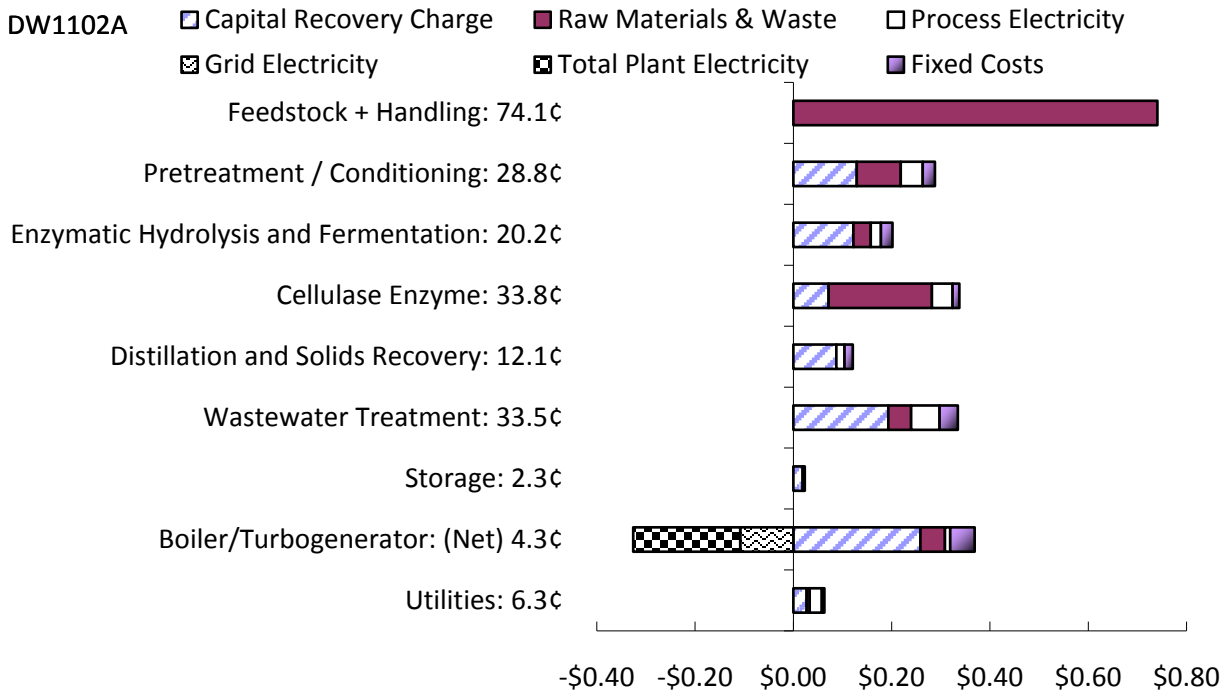

**Figure 17. Cost contribution details from each process area (per gallon EtOH)**

At the time of the 2002 design report, it was thought that the costs predicted then were probably too high for a company to start constructing a cellulosic ethanol plant based on undemonstrated technology. Today we are seeing several such biorefineries being planned or built at the pilot and commercial scale. The technoeconomic results reported here fall within the range claimed by these companies with respect to ethanol yield and TCI/gallon. The principal barrier to commercialization today is the current lack of access to capital for large, first-of-a-kind projects.

## 5 Analysis and Discussion

### 5.1 Carbon and Energy Balance

Overall material and energy balances were performed on the Aspen model. Table 35 shows the flow of carbon inputs and outputs. Closure on the carbon balance was 100.4%; small errors are due to the imperfect stoichiometry used to generate microbial cell mass in fermentation and wastewater treatment. As shown in the table, >96% of all carbon in the process enters in the biomass feed, with small amounts of additional carbon coming from glucose (for enzyme production) and fermentation nutrients like corn steep liquor.

Of the carbon inputs to the process, 29% of carbon atoms leave as ethanol. Major exit points for the balance of carbon (accounting for 66%) are the combustor stack and scrubber vent. We expect the amount of carbon exiting in the combustion exhaust to be rather large because most by-products (lignin, etc.) of this process are burned to form CO<sub>2</sub>. The majority of the carbon exiting the scrubber vent is also in the form of CO<sub>2</sub> from fermentation.

**Table 35. Ethanol Plant Overall Carbon Balance**

Stream	Carbon Flow (kmol/h)	% of Carbon Flow
Carbon inlets		
Stover feedstock	3,117	96.6%
Glucose	81	2.5%
Other	28	0.9%
Total	3,226	100.0%
Carbon outlets		
Combustion exhaust	1,670	51.8%
Ethanol product	941	29.2%
Scrubber vent	471	14.6%
Ash	10	0.3%
WWT brine	4	0.1%
Aerobic lagoons	88	2.7%
Enzyme production vents	54	1.7%
Total	3,238	100.4%

Only the carbohydrate components of the biomass can be converted to ethanol by fermentation. Of the carbon in the feed stream, 1,857 kmol/h (59.6%) is carbohydrates (glucan, xylan, arabinan, mannan, galactan, and sucrose); converting all of this carbon to ethanol represents the theoretical yield. According to Table 35, 1,412 kmol/h of the feed stream carbon is actually converted by the ethanol pathway (ethanol in the product plus CO<sub>2</sub> in the scrubber vent), so the actual yield is 76% of the theoretical yield. The same yield in the 2002 design was 80% of theoretical. Ours is slightly lower because we have not assumed conversion of the minor sugars galactose and mannose.

An energy balance was performed to compare the energy products from the process (ethanol and electricity) to the potential energy in the biomass feed. The potential energy for material streams used in this analysis has three contributions:

1. A combustion energy, defined as the lower heating value (LHV) of the stream at a reference temperature of 25°C.



2. A sensible heat effect to account for deviations of a stream's temperature from the reference temperature of 25°C. (This is computed by Aspen.)
3. A latent heat effect to account for major volatile components (e.g., water, ethanol, furfural) that are in a phase other than the reference phase.

The LHV is the energy released when a material is burned to form its combustion products, with water in the vapor phase. This is considered to be a more “true” heating value for transportation fuels, where the combustion water is generally not condensed to recover heat. On an LHV basis, any liquid water present in a material stream therefore reduces its combustion potential because heat must be expended to vaporize that water. Note that the sign convention in this basis follows the usual convention for heat of combustion: streams that can be burned (e.g., glucose or ethanol) have a negative potential energy. Streams that cannot be burned (e.g., water or sulfuric acid) have a positive potential energy.

A comparison of the major energy streams produced by the process to the combustion energy of the biomass feed is made in Table 36; a small discrepancy in the model's energy balance closure is due to reasons cited above. The combined energy available from the ethanol product and the exported electricity is 48% of the energy content of the biomass feed. The energy losses from the cooling tower and combustion exhaust are fairly large. Ambient heat losses are also significant; these include the wastewater lagoons and the air-cooled condenser on the rectification column. Compared to the 2002 design, less energy is lost from the cooling tower and combustion exhaust but more is lost through these ambient mechanisms. Note that “electricity reserve” refers to the total power demand to a small number of intermittent users in the plant (e.g., conveyor belts). This reserved electricity is not available for export and must be accounted for separately.

**Table 36. Ethanol Plant Overall Energy Balance**

Stream	Energy Flow (MMkcal/h)
<b>Major energy inputs</b>	
Stover feedstock	-316
Glucose	-8
Sulfuric acid	1
Ammonia	-4
Other chemicals	0
Well water	87
<b>Total</b>	<b>-239</b>
<b>Major energy outputs</b>	
Ethanol	-139
Cooling tower evaporation	-20
Combustion exhaust + ash	-12
Ambient heat losses	-63
Electricity export	-11
Electricity reserve	-4
WWT brine	8
<b>Total</b>	<b>-240</b>

As with the carbon balance, the energy content of non-carbohydrate compounds cannot be converted to ethanol. The total energy content of the carbohydrate components in the feed is -192

MMkcal/h. In other words, only 61% of the feedstock's combustion energy can be used to make ethanol. Given the energy content recovered as ethanol from Table 36, the percent of carbohydrate energy in the feed recovered as ethanol is about 72%, similar to the amount of carbohydrate carbon recovered as ethanol. A diagram of the overall mass, carbon, and energy balance is presented in Figure 18.

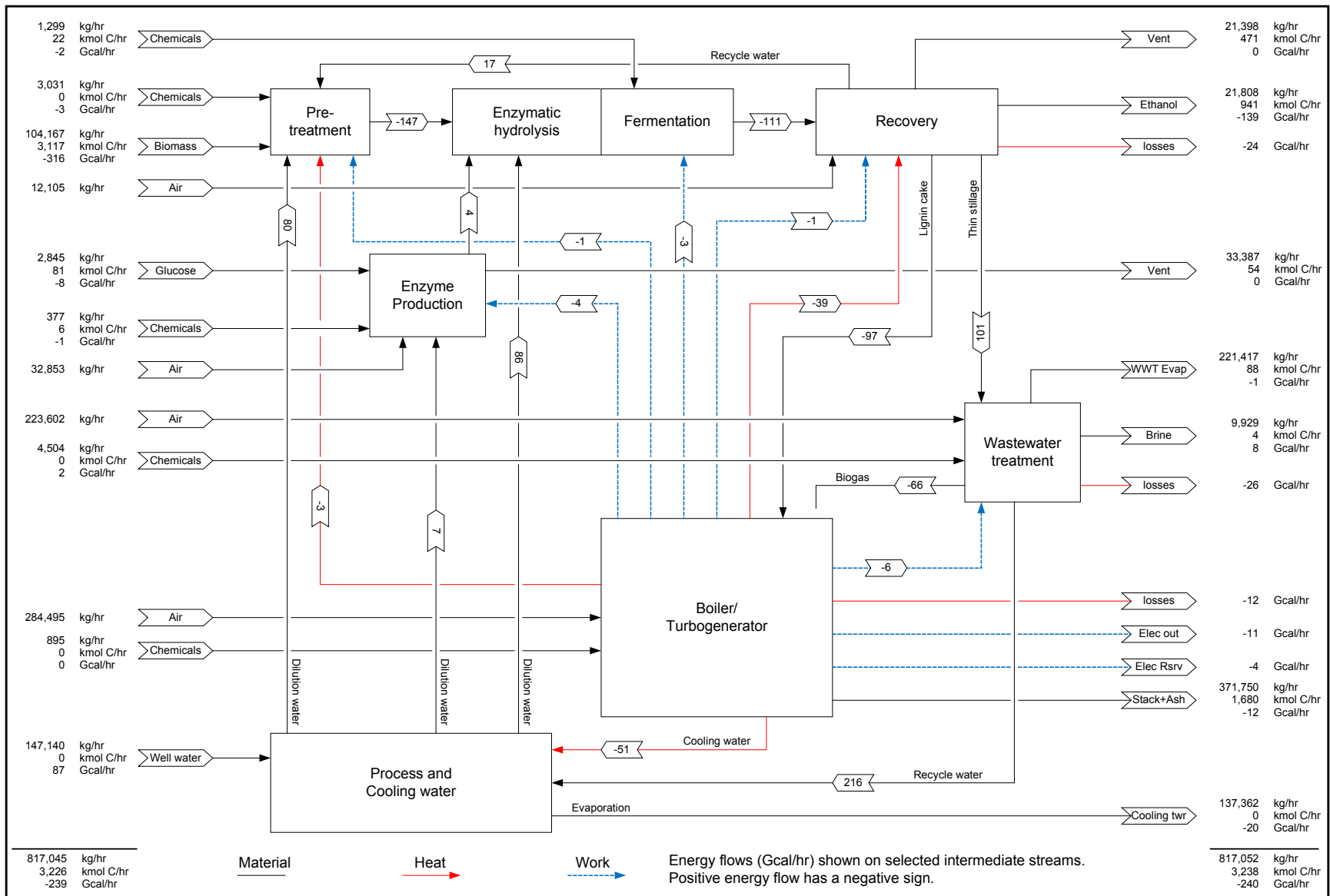

Figure 18. Mass, carbon, and energy balance diagram for the overall process

## 5.2 Water Balance

Consumptive water usage in the biochemical conversion process is generally considered to be high compared with a thermochemical conversion process or even a petroleum-based fuel process, when viewed in terms of gallons of water used per gallon of fuel produced (gal/gal). Based on detailed water balances from the Aspen simulation, the consumptive water usage in the 2002 design was 6.3 gallons of water used per gallon of ethanol [2]. Using the older model as a guide, Harris Group adjusted some assumptions around the cooling tower for a modest reduction in water usage, but as the model was updated for the present report, these adjustments were ultimately canceled out by more accurate accounting of cooling water streams and inclusion of the on-site enzyme production area. Without additional process modifications, the new design's consumptive water usage would therefore have been greater than in the 2002 design. In light of this, we gave more attention to water reduction and optimization.

As discussed in Section 3, the switch from lime to ammonia conditioning after pretreatment created a problem with ammonium sulfate and other inorganics accumulating in the evaporated stillage syrup. Boiler vendors were not comfortable quoting equipment to handle this stream, so we chose instead to handle the stillage in the wastewater treatment section. Doing so gave us the opportunity to remove the syrup evaporators, which in the 2002 design accounted for about one-half of the cooling tower losses and one-third of the total water losses. (Although the evaporators returned clean water to the process in the 2002 design, they were a net water loser—the amount of water returned to the process was less than the amount of water lost from the cooling tower as a result of condensing the recycled water.) Furthermore, the evaporated stillage syrup, which was sent to the combustor in the 2002 design, contained about 50% water. This water came out of the ethanol conversion process but was then lost via the combustor stack. By routing the stillage to wastewater treatment, all of the water contained in the stillage becomes theoretically recyclable to the process. The stillage evaporators in the 2002 design also acted as the condenser for the rectification column. Simply removing the evaporators and using cooling water in the rectifier condenser would therefore not have resulted in a significant reduction in consumptive water usage. Instead, Harris Group proposed placing an air-cooled condenser on the rectification column. The capital cost was about the same—\$487K for the air-cooled condenser versus \$440K for the cooling-water condenser initially specified by Megtec. The air-cooled unit uses about 300 hp (225 kW) of electricity, but this extra demand is insignificant to the overall plant, which generates more than 40 MW of electricity.

Taken together, elimination of the stillage evaporators combined with addition of the air-cooled rectifier condenser and improved heat integration in the front end of the process led to a reduction in the consumptive water usage from 6.3 gal/gal in 2002 to 5.4 gal/gal in the present design report. The overall water balance is shown in Table 37—the “makeup water” line item indicates the consumptive water usage.

Additional water enters the process via the feedstock and raw chemicals, both as free water and as “potential” water, i.e., the combustion product of lignin and unconverted sugars. Water is also consumed in hydrolysis reactions, and these are accounted for as well. We note that describing water usage with the units of gallons of water per gallon of ethanol can be somewhat misleading, because this quantity obviously depends on ethanol yield, and the yield in the present design is about 12% lower than in the 2002 design (79.0 gal/ton versus 89.7 gal/ton). Based on the actual makeup water flow, the present design has reduced the 2002 water usage by about 20% (150,000

kg/h versus 187,000 kg/h) for a plant that has the same feedstock flow rate and produces its own enzyme.

**Table 37. Ethanol Plant Water Balance**

<b>Inputs</b>	<b>kg/h</b>	<b>gal/gal</b>	<b>Outputs</b>	<b>kg/h</b>	<b>gal/gal</b>
Moisture in feedstock	20,833	0.76	Water in ethanol product	109	0.00
Water in glucose (Area 400)	427	0.02	Cooling tower evaporation	137,363	5.00
Water in raw chemicals	3,056	0.03	Stripped in enzyme aeration	774	0.03
Generated in enzyme prod.	1,291	0.02	Scrubber vent	522	0.02
Generated in fermentation	121	0.00	Destroyed in pretreatment	2,473	0.09
Generated in WWT	2,680	0.10	Destroyed in enzym. hydrolysis	2,631	0.10
Generated in combustor	23,869	0.87	WWT evaporation	4,350	0.16
Enzyme prod. air intake	638	0.02	WWT brine	4,967	0.18
Lignin cake dryer intake	237	0.01	Combustor stack	54,451	1.98
WWT lagoon aeration intake	4,379	0.16	Boiler blowdown vent	2,580	0.09
Combustor air intake	5,572	0.20			
Makeup (consumptive) water	147,140	5.35			
<b>Sum of inputs</b>	<b>210,243</b>	<b>7.65</b>	<b>Sum of outputs</b>	<b>210,220</b>	<b>7.65</b>

The ethanol conversion process itself is not a significant loser of water. Utilities are responsible for practically all water loss, with 90% of the net water loss due to cooling tower evaporation. Table 38 expresses the individual cooling water users (see Figure 14) in terms of their water loss responsibility in gal/gal.

**Table 38. Individual Contributors to Cooling Water Evaporation**

<b>Cooling Water User</b>	<b>MMkcal/h</b>	<b>% of duty</b>	<b>gal/gal</b>
Condensing turbine	50.7	52.1%	2.60
Chiller condenser	13.4	13.8%	0.69
Pre-hydrolysis cooler	10.6	10.9%	0.54
Hydrolysate flash	7.3	7.5%	0.37
Pre-fermentation cooler	5.9	6.1%	0.30
Ethanol product cooler	5.2	5.3%	0.27
Molsieve regeneration cooler	2.6	2.6%	0.13
Enzyme air compressor	1.2	1.2%	0.06
Beer column condenser	0.5	0.5%	0.02
<b>Total</b>	<b>97.4</b>	<b>100%</b>	<b>5.00</b>

The largest cooling water user is the condensing turbine (M-811), which is responsible for 2.6 gal/gal of water loss. A condenser on the turbine allows the steam to discharge from M-811 at a vacuum (about 0.1 atm) for maximum conversion of compressive energy to electricity. With the condensing turbine in place, the process generates enough electricity to supply all users in the plant plus a significant surplus, which is assumed to be sold to the grid. It would be difficult to eliminate the condensing turbine in the present design because without it, the plant would only be able to burn enough of the lignin and biogas to meet the steam demand. This would result in a significant excess of fuel that would have to be landfilled or disposed of somehow, or incinerated at no value. The plant would also no longer make enough electricity to support all of its users and would have to purchase the balance from the grid. Note that grid electricity also has a water usage associated with it, which in a full life cycle assessment would have to be attributed to the ethanol plant. Given the turbogenerator electricity output, the consumptive water use associated

with the condensing turbine can be expressed as 0.46 gal/kWh, which is roughly equivalent to the consumptive water use in coal-fired electricity plants [85].

The water-condensed chiller assumed here could potentially be replaced with an air-condensed system; however, these units do not have a very large capacity, so many parallel units would be required at a significant capital expense. The hydrolysate flash condenser and the pre-hydrolysis cooler could also potentially be replaced, but by inspection neither of them would break even with their water savings given the low cost of water used in the model.

The three low-temperature coolers in Table 38 (ethanol product cooler, pre-fermentation cooler, and molecular sieve regeneration cooler) account for another ~0.7 gal/gal of water loss, but these are not candidates for air-cooled heat exchangers because their outlet temperature is too low (32°–35°C). The other users below these in Table 38 either do not represent a significant cooling water duty or are likely to come skidded with cooling water hookups.

### **5.3 The Cost of Sugar**

Sugars are an intermediate product in the formation of ethanol. Hemicellulose is hydrolyzed to form xylose, arabinose, galactose, and mannose in the pretreatment area. Cellulase enzyme hydrolyzes the cellulose into glucose. NREL has received feedback from the biofuels industry (mainly from non-ethanol producers) that knowing the production cost of sugar from lignocellulosic biomass is important to them as it can help them compare feedstocks and pretreatment processes, at least to the extent that these things can be considered modular to their process. To that end, NREL maintains a process model for intermediate sugar production that reports a minimum sugar selling price (MSSP, \$/lb) [86, 87]. It should be stressed that the sugar stream produced in this analysis is strictly “imaginary.” The purpose of this analysis is merely to separate the cost of producing sugars from the downstream costs of producing ethanol or other products.

In the sugar cost analysis, enzymatic hydrolysis is assumed to be carried out in a sterile way and nearly to completion so that a transferable sugar stream is produced. The sugar model basically follows the ethanol model through enzymatic hydrolysis. A lignin press with counter-current washing is added after hydrolysis to separate lignin and unreacted insoluble solids from the dilute mixed sugar stream. The combustion section is retained, and an electricity co-product credit is assumed for these solids. A wastewater cost is kept to account for treatment of the pretreatment flash vapor; however, given that the beer column stillage (the principle wastewater feed in the ethanol model) is not applicable in the sugar model, an on-site wastewater facility is no longer justified. Instead, an operating cost of \$0.09/kg COD is applied for disposal of the wastewater material to off-site treatment. Fermentation, distillation, stillage treatment, and ethanol storage are completely removed from the sugar model. As in the ethanol process design, enzymatic hydrolysis is assumed to achieve 90% cellulose-to-glucose conversion.

Mass balances and capital and operating costs were determined for the sugar process using the same DCFROR methodology described for the ethanol process in Section 4, and the minimum dilute sugar selling price was calculated to be 11.6 cents/lb (2007\$); detailed economics for this case are shown in Figure 19. Table 39 shows the sugar stream composition. It is important to note that this value is not directly comparable to a traditional commodity sugar derived from corn or sugarcane, as the cellulosic sugar material contains a mixture of C6 and C5 sugars at a

relatively dilute concentration (set by solids loading limitations in enzymatic hydrolysis) as well as other contaminants such as furfurals, inorganic salts, residual lignin, etc.

**Table 39. Mixed Sugar Stream Composition**

<b>Component</b>	<b>Transfer Concentration (g/L)</b>	<b>Upgraded Concentration (g/L)</b>
Glucose	75.9	289.8
Xylose	42.1	160.8
Arabinose	5.1	19.6
Mannose	1.3	4.8
Galactose	3.0	11.5
<b>Total sugars</b>	<b>127.4</b>	<b>486.6</b>
Extractive organics	31.2	119.1
Solubilized lignin	1.7	6.4
HMF	0.9	3.6
Furfural	0.9	0.1
Ammonium sulfate	5.5	21.0
Ammonium acetate	4.1	15.8
Insoluble solids	0.3	1.1

Table 39 also presents a composition for an “upgraded” sugar stream. Given the dilute nature of the raw sugar stream at 127 g/L total sugars, the associated selling price of 11.6 cents/lb should be viewed more as a “transfer price” where the raw cellulosic sugar material is sold over the fence to a conversion process that can use dilute sugar. In order to present a sugar price that more closely resembles traditional commodity sugars, we also evaluated the cost of concentrating the material on-site. A triple-effect evaporator system was added to the model, with heat input specified to achieve 50% water in the syrup (less than 50% sugar given the additional components present). The heat for concentrating the sugar syrup was assumed to come from supplemental natural gas rather than from the residual lignin. The 2007 price for natural gas for industrial use was taken from the U.S. Energy Information Administration, at \$7.68 per thousand cubic feet [88]. After considering the added cost of the evaporator and condenser equipment as well as the cost of natural gas, the minimum sugar selling price was calculated to be 14.3 cents/lb (2007\$), associated with 487 g/L total sugars. This concentrated sugar still has non-sugar compounds that may require cleanup, at additional cost.

# Sugar Production Process Engineering Analysis

Corn Stover Design Report Case: DW1102A  
 Dilute Acid Prehydrolysis with Enzymatic Saccharification  
 All Values in 2007\$

Minimum Sugar Selling Price **\$0.1158 /lb, Dilute sugars**

Sugar Production (MMlb / Year) 910.4  
 Sugar Yield (lb / Dry U.S. Ton Feedstock) 1179  
 Feedstock Cost \$/Dry U.S. Ton \$58.5 (Includes handling)  
 Internal Rate of Return (After-Tax) 10%  
 Equity Percent of Total Investment 40%

Capital Costs		Manufacturing Costs (cents/lb sugar)	
Pretreatment & Conditioning	\$33,000,000	Feedstock + Handling	4.963
Enzymatic Hydrolysis	\$19,600,000	Sulfuric Acid	0.164
On-Site Enzyme Production	\$18,300,000	Ammonia	0.483
Solids Recovery	\$7,300,000	Glucose (Enzyme Production)	1.296
Wastewater Treatment	\$0	Other Raw Materials	0.107
Storage	\$1,900,000	Waste Disposal	0.222
Boiler/Turbogenerator	\$66,000,000	Electricity	-0.676
Utilities	\$6,900,000	Natural Gas (sugar concentration)	0.000
Total Installed Equipment Cost	\$152,900,000	Fixed Costs	0.979
Added Costs	\$127,000,000	Capital Depreciation	0.978
(% of TPI)	45%	Average Income Tax	0.559
		Average Return on Investment	2.505
Total Project Investment	\$279,900,000		
		Manufacturing Costs (\$/yr)	
Installed Equipment Cost/Annual lb	\$0.17	Feedstock + Handling	\$45,200,000
Total Project Investment/Annual lb	\$0.31	Sulfuric Acid	\$1,500,000
		Ammonia	\$4,400,000
Loan Rate	8.0%	Glucose (Enzyme Production)	\$11,800,000
Term (years)	10	Other Raw Matl. Costs	\$1,000,000
Capital Charge Factor	0.131	Waste Disposal	\$2,000,000
		Electricity	-\$6,100,000
		Natural Gas (sugar concentration)	\$0
Sugar Concentration (g/L)	127	Fixed Costs	\$8,900,000
Energy Efficiency (LHV sugar/LHV feed)	50.8%	Capital Depreciation	\$8,900,000
		Average Income Tax	\$5,100,000
		Average Return on Investment	\$22,800,000
		Excess Electricity (KWH/lb)	0.12
		Plant Electricity Use (KWH/lb)	0.26
		Plant Water Use (gal/lb)	0.4
		Specific Operating Conditions	
		Enzyme Loading (mg/g cellulose)	20
		Saccharification Time (days)	3.5

Figure 19. Economic summary for dilute sugar production



## 5.4 Cost Sensitivity Analysis

Here we present a limited sensitivity analysis using the technoeconomic model presented in this report. More exhaustive sensitivity analyses are planned for future publication, including sensitivity to feedstock variability and an overarching Monte Carlo sensitivity analysis including conversion and economic assumptions.

A single-point sensitivity was performed on the Aspen model using the variables and limits shown in Table 40. The baseline for all variables was the 2012 performance target used in the design case described previously. Reasonable minima and maxima for each variable were chosen with a group of NREL researchers. Each variable was changed to its maximum and minimum value while all others were held constant. The sensitivities of MESP and ethanol yield to these parameters are displayed as tornado charts in Figure 20. These indicate that conversion parameters have the largest (and only) impacts on ethanol yield. Conversion parameters also factor heavily into MESP, along with parameters that affect capital and operating costs. The uncertainty in capital costs resulting from the factored approach we used ( $\pm 25\%$ ) has the largest impact to MESP but is on the order of other key parameters. We note that this is an imperfect comparison because the TCI bar represents a true uncertainty while the other bars are more accurately called a risk, in the sense that they represent a range of results that we might expect to see in the pilot-scale demonstration runs. The magnitude of these bars is of course a function of the range we chose in Table 40. Conversion parameters have their own uncertainty due to the laboratory measurements involved. We plan to quantify the sensitivity of MESP to these uncertainties in a future paper.

**Table 40. Assumptions Varied in the Sensitivity Analysis**

	<b>Assumption Name</b>	<b>Min</b>	<b>Baseline</b>	<b>Max</b>
<b>Pretreatment</b>	PT % solids	25%	30%	40%
	PT acid loading (mg/g)	10	22.1	35
	PT temperature °C	150	158	170
	PT xylan to xylose	80%	90%	92%
	PT xylan to furfural	3%	5%	8%
	PT glucan to glucose	6%	9.9%	12%
<b>Enz hydrolysis</b>	EH % solids	17.5%	20%	25%
	EH cellulose to glucose	75%	90%	95%
	EH enzyme loading mg/g	10	20	30
	EH time (d)	2	3.5	5
<b>Fermentation</b>	FERM contamination losses	0%	3%	6%
	FERM xylose to ethanol	75%	85%	90%
	FERM arabinose to ethanol	0%	85%	85%
	FERM time (d)	1	1.5	3
<b>Capital</b>	Total capital investment	-25%	-	+25%

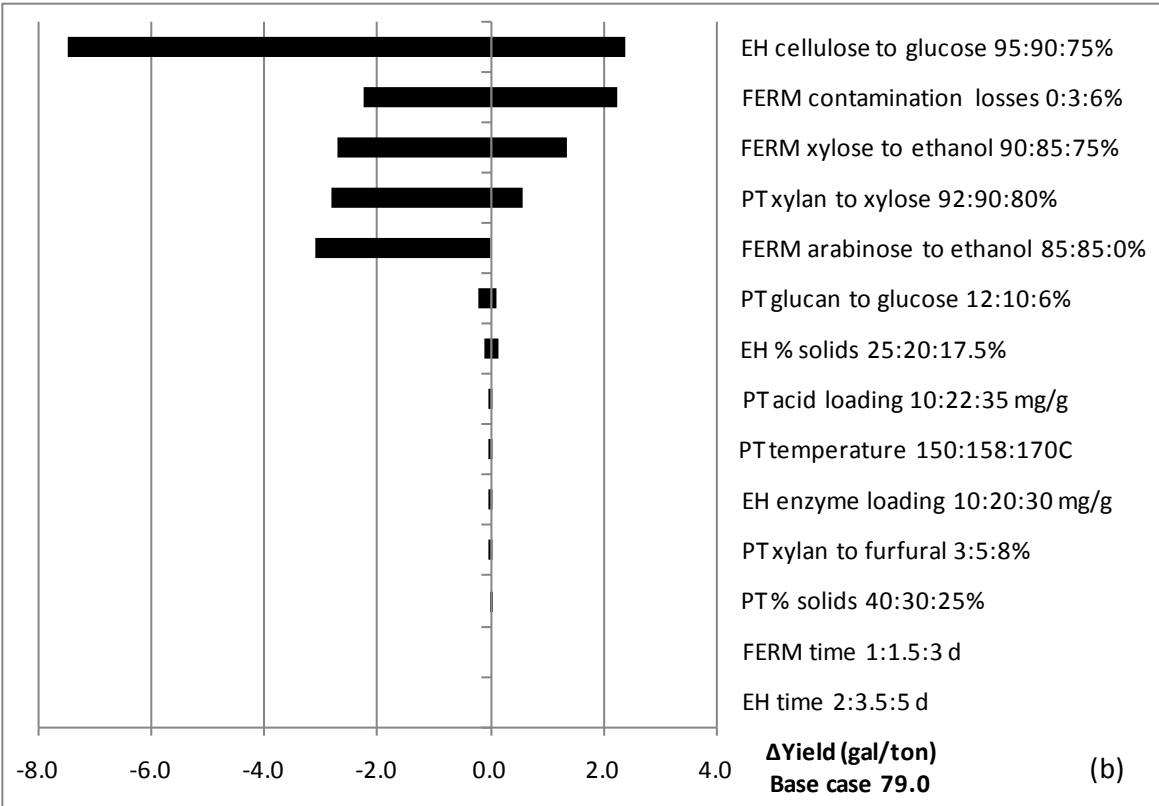
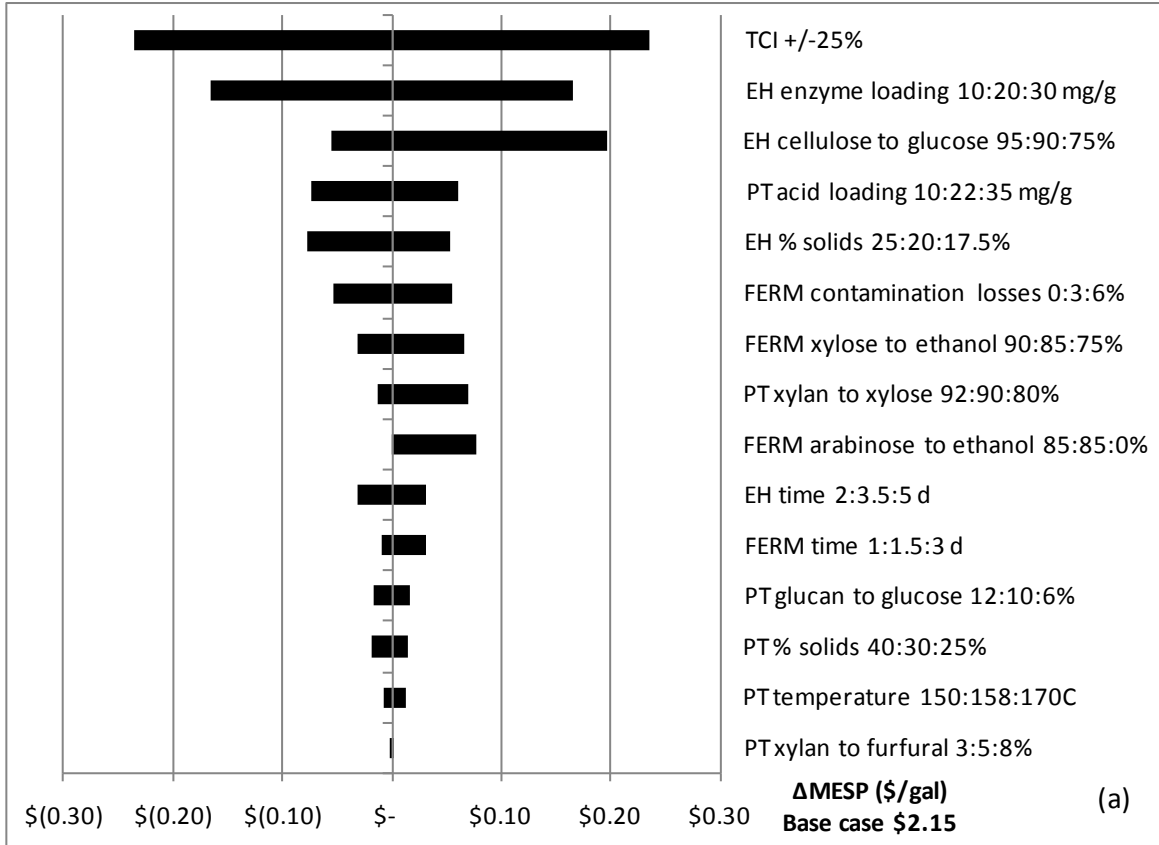

Figure 20. Single-point sensitivity tornado charts for (a) MESP and (b) ethanol yield

## 5.5 State of Technology Back-Casting

The annual State of Technology (SOT) assessment is an essential activity for biochemical conversion research at NREL. The state of technology process is complementary to the design report. Without reconfiguring the unit operations in the Aspen model, the projected conversions from the design report are replaced by present conversions that have been experimentally verified at the bench and/or pilot scale on process-relevant material. By comparing the SOT year-over-year, research advances can be quantified in terms of economic improvements in the overall process.

We understand that “State of Technology” is arguably a misnomer because no commercial cellulosic ethanol plants exist today. The aim of an SOT case for a given year is not to report a current commercial production cost for cellulosic ethanol, but to reflect NREL’s best estimate of ethanol production costs in a hypothetical  $n^{\text{th}}$  plant using the current best slate of demonstrated technical capabilities. The SOT uses conversion performances that have been demonstrated experimentally, with a preference for data obtained in NREL’s ~1 ton/day pilot facility. Not all conversion parameters can be practically measured in the pilot plant, so the SOT cases contain both laboratory-scale data and pilot-scale data. There is of course some risk in assuming that bench-scale performance data is applicable at large scale.

Since its inception, the SOT analysis has been based on the technoeconomic model from the 2002 design report [2]. Feedstock costs and year-dollars were updated, and some minor process modifications were made, but the basic Aspen model stayed the same. Using the new Aspen model described in this report, we performed a back-casting of the 2007–2010 SOTs using their conversion results. Table 41 shows these back-cast cases and their related MESP values. Much of the research that went into demonstrating these cases was discussed in Sections 3.2 and 3.3. Also shown in Table 41 are the 2011 interim conversion targets.

**Table 41. Back-Casted State of Technology Cases and Future Targets**

	2007 SOT	2008 SOT	2009 SOT	2010 SOT	2011	2012
<b>Minimum Ethanol Selling Price (\$/gal)</b>	<b>\$3.53</b>	<b>\$3.46</b>	<b>\$3.08</b>	<b>\$2.67</b>	<b>\$2.62</b>	<b>\$2.15</b>
<b>Feedstock contribution</b>	<b>\$1.01</b>	<b>\$0.94</b>	<b>\$0.85</b>	<b>\$0.72</b>	<b>\$0.76</b>	<b>\$0.74</b>
<b>Enzyme contribution</b>	<b>\$0.39</b>	<b>\$0.38</b>	<b>\$0.36</b>	<b>\$0.36</b>	<b>\$0.43</b>	<b>\$0.34</b>
<b>Non-enzyme conversion contribution</b>	<b>\$2.14</b>	<b>\$2.14</b>	<b>\$1.87</b>	<b>\$1.59</b>	<b>\$1.43</b>	<b>\$1.07</b>
TCI/annual gallon	\$11.33	\$11.32	\$10.60	\$10.15	\$9.40	\$6.92
Yield (gallon/dry ton)	69	70	76	75	78	79
<b>Technical targets</b>						
<b>Feedstock</b>						
Feedstock cost (\$/dry ton)	\$69.60	\$65.30	\$62.05	\$53.70	\$59.60	\$58.50
<b>Pretreatment</b>						
Xylan to xylose (including enzymatic)	75%	75%	84%	85%	88%	90%
Xylan to degradation products	13%	11%	6%	8%	5%	5%
Hydrolysate solid-liquid separation	Yes	Yes	Yes	Yes	Yes	No
Xylose sugar loss	2%	2%	2%	2%	1%	1%
Glucose sugar loss	1%	1%	1%	1%	1%	0%
<b>Enzymatic hydrolysis &amp; fermentation</b>						
Enzyme loading (mg/g)	20	20	20	20	25	20
Combined sacch & ferm time (d)	7	7	7	5	5	5
Corn steep liquor loading (wt %)	1%	1%	1%	1%	0.6%	0.25%
Overall cellulose to ethanol	86%	86%	84%	86%	86%	86%
Xylose to ethanol	76%	80%	82%	79%	85%	85%
Arabinose to ethanol	0%	0%	51%	68%	80%	85%
<b>Operating parameters</b>						
Pretreatment solids loading (wt %)	30%	30%	30%	30%	30%	30%
Pretreatment temperature (°C)	190	190	158	158	158	158
Acid loading (mg/g dry biomass)	38.0	30.0	24.5	22.1	22.1	22.1
Secondary oligomer hold step	No	Yes	Yes	Yes	Yes	Yes
Ammonia loading (g per L of liquor)	12.9	12.9	9.8	4.8	4.8	4.8
Conditioning mode	Liquor	Liquor	Liquor	Liquor	Liquor	Whole slurry
Saccharification mode	Washed solids	Washed solids	Washed solids	Washed solids	Whole slurry	Whole slurry
Enz. hydrolysis solids loading (wt %)	20%	20%	20%	17.5%	20%	20%
<b>Reference Aspen model (DW-)</b>	<b>1102F</b>	<b>1102E</b>	<b>1102D</b>	<b>1102C</b>	<b>1102B</b>	<b>1102A</b>

The enzyme costs in Table 41 were computed by the on-site enzyme model described in Section 3.4. The loadings were set for each case, and the model computed the amount of enzyme needed and its cost. No research advances were assumed in the enzyme production section, so in effect the unit cost of enzyme protein (\$/kg) remained constant across all cases. The enzyme loading itself is flat at 20 mg enzyme protein/g cellulose from 2007–2010 and then increases to 25 mg/g in 2011. This reflects a change in process integration from washed-solids to whole-slurry enzymatic hydrolysis. The rationale for this change was that it will allow us to eliminate all solid-liquid separation steps in the process once a suitable whole-slurry hydrolysate conditioning process is found. To date, whole-slurry experiments have indicated that a higher enzyme loading is required to reach acceptable conversion yields of cellulose to glucose. Reducing this enzyme loading back to 20 mg/g is a research target for 2012.

## 6 Concluding Remarks

### 6.1 Summary

NREL analysts and process engineers made a significant effort in 2009–2010 to update the 2002 design report of Aden et al. [2] that described the biochemical conversion of lignocellulosic biomass (corn stover) to ethanol. The purpose of these design reports is to investigate the process design and economics of converting lignocellulosic biomass to ethanol at scale and at a profit. The end result of the analysis is an absolute selling price for ethanol that is based on reasonable process engineering and plant design assumptions. This information is used to predict the cost-competitiveness and market penetration potential of cellulosic ethanol in comparison with petroleum-derived fuels and corn ethanol. The design report also helps NREL and DOE to direct their research by using it to examine the sensitivity of the selling price to process alternatives, equipment and operating cost reductions, and advances in conversion research. Proposed research and its anticipated results can be translated into a new design with new economics that can be compared with the benchmark case.

In updating the design report, NREL and Harris Group revisited all major assumptions of the 2002 and earlier design reports, questioning their validity and making adjustments or improvements where needed. This included taking advantage of new technologies and engineering practices. All equipment costs and major raw material costs were updated with new quotes obtained in 2009\$ and 2010\$.

Some of the notable conversion process changes from the 2002 design were the following:

- The corn stover feedstock composition used in the design was updated to reflect a composition with a carbohydrate profile closer to the mean observed in NREL studies.
- A highly detailed pretreatment reactor configuration was provided by Andritz, Inc. The specifications of the reactor were mutually agreed upon between Andritz, Harris Group, and NREL researchers.
- Ammonia conditioning of the pretreated biomass replaced the previous practice of overliming followed by gypsum precipitation. The ammonia process allows the hydrolysate to be conditioned as a whole slurry, eliminating a solid-liquid separation step.
- The enzymatic hydrolysis and fermentation section was previously modeled as a continuous train but is now modeled as a batch system. Upstream of the batch reactors, a continuous high-solids enzymatic hydrolysis reactor was added.
- An on-site enzyme production section replaced the previous purchased-enzyme cost model. Cellulase enzyme is produced using a *T. reesei* analog on glucose substrate. The purpose of the enzyme production section was to improve transparency on the true cost of enzymes for cellulosic ethanol and not to make a judgment call as to whether enzymes should be made on-site or purchased from a distributor.
- The wastewater treatment section was completely redesigned in high detail to accurately model treatment of the elevated nitrogen and sulfur levels that resulted from the switch from overliming to ammonia conditioning.

The end result of the technoeconomic analysis was a predicted minimum ethanol selling price (MESP) of \$2.15/gal (2007\$). This reflects a \$0.74/gal contribution from feedstock, a \$0.34/gal contribution from enzymes, and a \$1.07/gal contribution from the remainder of the conversion process.

## 6.2 Variance from the 2002 Design

In the original 2002 design report, which projected 2012 technology, the modeled 2012 MESP was \$1.07/gal ethanol in 2000\$ (\$1.29/gal if directly converted to 2007\$). Since then, the projected 2012 model has evolved to include inflation in capital and chemical costs, new feedstock costs from INL, elimination of feedstock handling and yard workers, and some key process changes, including the oligomer conversion step in pretreatment and the switch to ammonia conditioning. The most recently updated MESP target for 2012 was \$1.49/gal ethanol in 2007\$ [27]. The model used to compute this price was based on the 2008 State of Technology model [21], which in turn was based on the 2002 design model. Table 42 compares this previous model to the present design, with the costs broken down by process area (note that the totals may be appear to be off by a cent due to rounding).

**Table 42. Comparison of the Previous Target Case and the Present Design (2007\$/gal)**

<b>Model Comparison by Area</b>	<b>2012 Model Based on 2008 SOT</b>	<b>New 2012 Model (This Work)</b>	<b>Difference</b>
Feedstock	\$0.57	\$0.74	\$0.17
Feed handling (included in feedstock cost in current model)	\$0.01	\$0.00	-\$0.01
Pretreatment/conditioning	\$0.26	\$0.29	\$0.03
Saccharification and fermentation	\$0.12	\$0.20	\$0.08
Cellulase	\$0.12	\$0.34	\$0.22
Distillation and solids recovery	\$0.16	\$0.12	-\$0.04
Wastewater treatment	\$0.03	\$0.34	\$0.31
Storage	\$0.02	\$0.02	\$0.01
Boiler/turbogenerator (includes electricity co-product credit)	\$0.16	\$0.04	-\$0.12
Utilities	\$0.06	\$0.06	\$0.01
<b>TOTAL (MESP)</b>	<b>\$1.49</b>	<b>\$2.15</b>	<b>\$0.66</b>

Because the MESP is expressed in \$/gal, it depends of course on the overall ethanol yield, which in the present design is about 12% lower than in the older model. Overall, there was a \$0.66/gal (44%) increase over the previous target of \$1.49/gal. When broken down by process area, we see in Table 42 that the more notable changes in cost came from the enzyme section (due to a change in the way enzyme costs were determined, i.e., by on-site production instead of an assumed price per gallon of ethanol) and from the wastewater area (material that was previously burned is now being routed to wastewater). The individual contributors to the cost delta are expressed in a different way in Table 43. At \$0.22 per gallon, the new enzyme cost model is the largest contributor to the MESP difference between the two models. Another \$0.08 can be attributed to the lower yield from the new feedstock composition, and \$0.10 to an increase in the feedstock cost. A total of \$0.21 can be attributed to net increases in the capital equipment costs, chemical costs, and labor rates.

**Table 43. Individual Contributors to the Change in MESP**

<b>Contributor</b>	<b>Amount (2007\$/gal)</b>	<b>Explanation</b>
Feedstock cost	\$0.10	From \$50.90 to \$58.50 (new grower payment assumption)
Feedstock composition	\$0.08	Lower yield from more representative feedstock composition
Cellulase	\$0.22	On-site production model predicted \$0.34/gal versus the previous \$0.12/gal purchased model
Electricity credit	-\$0.07	Larger fraction of biomass is converted to electricity with the updated composition
Capital	\$0.30	Net increase in the capital equipment required
Financial assumptions	-\$0.06	100% equity versus 40% equity with 8% interest
Chemicals	\$0.06	New chemical costs
Fixed costs	\$0.03	New labor costs
	<b>\$0.66</b>	

### 6.3 Future Work

The overarching near-term goal for DOE’s Office of the Biomass Program is to demonstrate the cost-competitiveness of cellulosic ethanol with petroleum fuels by 2012. NREL and DOE have agreed on a slate of conversion parameters that are likely achievable by 2012. These development targets lead to an  $n^{\text{th}}$ -plant MESP of \$2.15/gal by 2012, as modeled by the process design described in this report. One of NREL’s main tasks is to perform integrated pilot-scale testing that demonstrates these conversion targets in 2012. The pilot-scale tests will make use of NREL’s biochemical process integration expertise and other core conversion research occurring at smaller scales.

Pretreatment research will continue to focus on increasing xylan-to-xylose conversion, both by optimizing the conditions between the first step of pretreatment and the secondary oligomer conversion step and by supplementing enzymatic hydrolysis with accessory xylanase enzymes. Enzymatic hydrolysis research will have a significant focus on integrated experiments and on optimizing conditions using the newest pretreated material with the highest xylose conversion. Another focus in the pretreatment and enzymatic hydrolysis areas will be to reduce chemical usage and severity in pretreatment while maintaining good enzyme digestibility of the pretreated biomass. These experiments must be performed in an integrated way with fermentation. Also, some of the results described in this design report use an advanced research enzyme preparation. It is likely we will continue to experiment with more advanced preparations in 2011 and beyond.

In fermentation research, some of the advanced strains being developed by the awardees of DOE’s ethanologen strain solicitation are slated to be tested in NREL’s pilot plant. There is also a significant internal effort to genetically engineer the NREL *Z. mobilis* strain with a metabolic pathway to convert arabinose to ethanol. This is a risk mitigation strategy should the solicitation strains prove difficult to integrate into NREL’s pilot-scale ethanol process.

Process integration research will continue to focus on cost reduction through process design. Obtaining a pretreatment, conditioning, and enzymatic hydrolysis process that can be carried out as a whole slurry, without a solid-liquid separation step, is key to future cost reductions and will be studied aggressively. Other areas where process integration research plays a role is in reducing costs of fermentation media and mitigating the problems in back-end cleanup and

wastewater treatment discussed in this report. These areas of the process will receive much more scrutiny between now and 2012.

In technoeconomic analysis research, we have plans to perform an extensive Monte Carlo cost-sensitivity analysis using the new design report process described here. The analysis will examine the sensitivity to economic parameters such as raw material and equipment costs, to the expected compositional variability of corn stover, and to the specific process parameters defined in Aspen, such as fermentation conversions. There is also an interest in updating the Aspen model to handle alternate feedstocks: switchgrass, sorghum, wheat straw, sugarcane bagasse, etc. Each feedstock may require key process changes to overcome biomass recalcitrance or a thermal deficit. Once we have determined the similarities and difference between feedstocks, the goal is to produce a single, flexible model that can handle them all.

In addition to alternate feedstocks, this work is applicable to further technoeconomic analysis of advanced biofuels. The cellulosic ethanol process described here is only one of many pathways by which a transportation fuel can be produced from biomass. In the future, advanced conversion technologies that produce infrastructure-compatible or “drop-in” fuels (primarily gasoline, diesel, and/or jet-range hydrocarbons) will have an increasing importance in NREL’s and DOE’s research portfolio. Figure 21 shows some example pathways that yield such fuels from sugar; most of these technologies are already being researched by startup companies and academic institutions using clean sugar from corn or sugar cane. NREL plans to leverage its expertise in sugar generation from lignocellulosic material to help move these technologies away from food-based sugars and toward sustainable biomass.

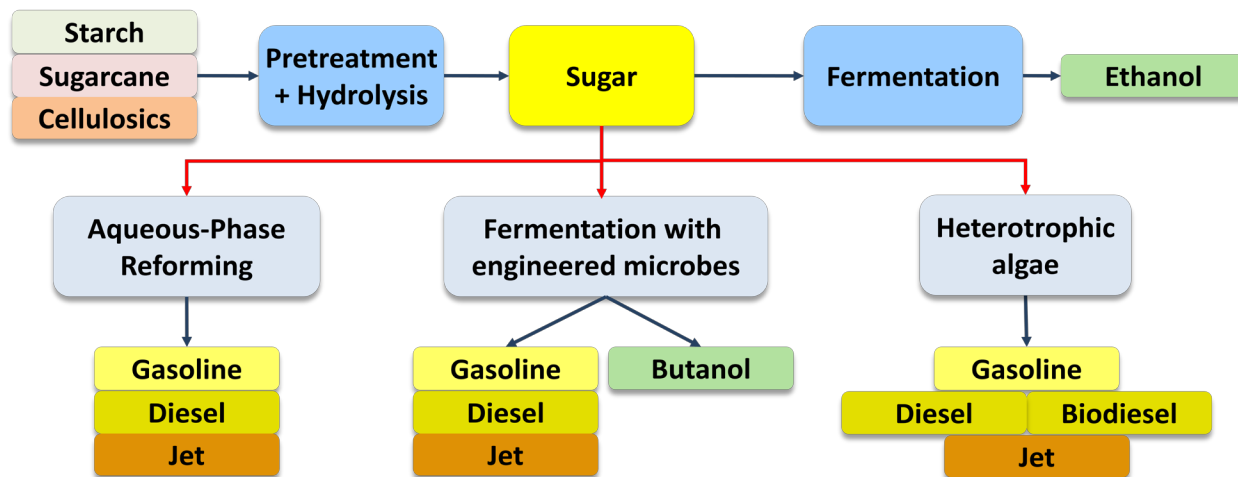

**Figure 21. Sugar-based pathways for conventional and advanced biofuels**

In a technoeconomic model of an advanced conversion process using cellulosic sugar, the front end of the Aspen model described in this report would largely stay the same through pretreatment and enzymatic hydrolysis, up to the production of a sugar intermediate. The sugar conversion and product recovery sections would be replaced with new sections that describe the technologies in Figure 21. Our process models for sugar production and the specialized wastewater and utilities sections should therefore be considered modular to these future studies.



## References

NREL milestone reports cited below cannot be accessed outside of NREL and DOE. Readers may contact the authors of the specific reference to determine if this information has been made public since publication of this design report.

1. Wooley, R.; Ruth, M.; Sheehan, J.; Ibsen, K. *Lignocellulosic Biomass to Ethanol Process Design and Economics Utilizing Co-Current Dilute Acid Prehydrolysis and Enzymatic Hydrolysis: Current and Future Scenarios*. Report No. NREL/TP-580-26157. Golden, CO: National Renewable Energy Laboratory, July 1999. <http://www.nrel.gov/docs/fy99osti/26157.pdf>.
2. Aden, A.; Ruth, M.; Ibsen, K.; Jechura, J.; Neeves, K.; Sheehan, J.; Wallace, B.; Montague, L.; Slayton, A.; Lukas, J. *Lignocellulosic Biomass to Ethanol Process Design and Economics Utilizing Co-Current Dilute Acid Prehydrolysis and Enzymatic Hydrolysis for Corn Stover*. Report No. NREL/TP-510-32438. Golden, CO: National Renewable Energy Laboratory, June 2002. <http://www.nrel.gov/docs/fy02osti/32438.pdf>.
3. “Aspen Plus.” Burlington, MA: Aspen Technology. <http://www.aspentech.com/products/aspen-plus.cfm>.
4. Tao, L.; Aden, A. “The Economics of Current and Future Biofuels.” *In Vitro Cell Dev. Biol.*; Vol. 45, 2009; pp. 199-217.
5. F.O. Lichts. *Ethanol Production Costs: A Worldwide Survey*. Turnbridge Wells, Kent, UK: Agra Informa, 2007.
6. Kwiatkowski, J.R.; McAloon, A.J.; Taylor, F. “Modeling the Process and Costs of Fuel Ethanol Production by the Corn Dry-Grind Process.” *Ind. Crops Prod.*; Vol. 233, 2006; pp. 288-296.
7. Rodrigues, A.P. *Participação dos fornecedores de cana na cadeia do açúcar e álcool*. Congresso Internacional de Tecnologias na Cadeia Produtiva, Concana Uberaba, MG, março de, 2007 (in Portuguese).
8. Seabra, J.E.A. *Technical-Economic Evaluation of Options for Whole Use of Sugar Cane Biomass in Brazil*. Ph.D. Thesis. Campinas Faculdade de Engenharia Mecânica Universidade Estadual de Campinas, 2007 (in Portuguese).
9. Graboski, M.S.; McCormick, R.L. “Combustion of Fat and Vegetable Oil Derived Fuels in Diesel Engines.” *Prog. Energy Combust. Sci.*; Vol. 24, 1998; pp. 125–164.
10. Haas, M.J.; McAloon, A.J.; Yee, W.C.; Foglia, A.T. “A Process Model to Estimate Biodiesel Production Cost.” *Biores. Technol.*; Vol. 97, 2006; pp. 671–678.
11. Laser, M.; Larson, E.; Dale, B.; Wang, M.; Greene, N.; Lynd, L.R. “Comparative Analysis of Efficiency, Environmental Impact, and Process Economics for Mature

- Biomass Refining Scenarios.” *Biofuels, Bioproducts, & Biorefining*; Vol. 3, 2009; pp. 247-270.
12. Kazi, F.K.; Fortman, J.A.; Anex, R.P.; Hsu, D.D.; Aden, A.; Dutta, A.; Kothandaraman, G. “Techno-Economic Comparison of Process Technologies for Biochemical Ethanol Production from Corn Stover.” *Fuel*; Vol. 89, 2010; pp. S20-S28.
  13. Klein-Marcuschamer, D.; Oleskowicz-Popiel, P.; Simmons, B.A.; Blanch, H.W. “Technoeconomic Analysis of Biofuels: A Wiki-Based Platform for Lignocellulosic Biorefineries.” *Biomass and Bioenergy*; Vol. 34, 2010; pp. 1914-1921.
  14. Klein-Marcuschamer, D.; Oleskowicz-Popiel, P.; Simmons, B.A.; Blanch, H.W. “JBEI Corn Stover to Ethanol Model.” U.S. Department of Energy Joint BioEnergy Institute Wiki, [http://econ.jbei.org/wiki/index.php/Corn\\_Stover\\_to\\_Ethanol\\_Model](http://econ.jbei.org/wiki/index.php/Corn_Stover_to_Ethanol_Model).
  15. Huang, H.J.; Ramaswamy, S.; Al-Dajani, W.; Tschirner, U.; Cairncross, R.A. “Effect of Biomass Species and Plant Size on Cellulosic Ethanol: A Comparative Process and Economic Analysis.” *Biomass and Bioenergy*; Vol. 33, 2009; pp. 234-246.
  16. Sendich, E.N.; Laser, M.; Kim, S.; Alizadeh, H.; Laureano-Perez, L.; Dale, B.; Lynd, L. “Recent Process Improvements for the Ammonia Fiber Expansion (AFEX) Process and Resulting Reductions in Minimum Ethanol Selling Price.” *Bioresource Technology*; Vol. 99, 2008; pp. 8429-8435.
  17. Gnansounou, E.; Dauriat, A. “Techno-Economic Analysis of Lignocellulosic Ethanol: A Review.” *Bioresource Technology*; Vol. 101, 2010; pp. 4980-4991.
  18. Bals, B.; Wedding, C.; Balan, V.; Sendich, E.; Dale, B. “Evaluating the Impact of Ammonia Fiber Expansion (AFEX) Pretreatment Conditions on the Cost of Ethanol Production.” *Bioresource Technology*; Vol. 102, 2011; pp. 1277-1283.
  19. Piccolo, C.; Bezzo, F. “A Techno-Economic Comparison Between Two Technologies for Bioethanol Production from Lignocellulose.” *Biomass and Bioenergy*; Vol. 33, 2009; pp. 478-491.
  20. National Academy of Sciences. *Liquid Transportation Fuels from Coal and Biomass: Technological Status, Costs, and Environmental Impacts*. Washington, DC: The National Academies Press, 2009. <http://www.nap.edu/catalog/12620.html>.
  21. Humbird, D.; Aden, A. *Biochemical Production of Ethanol from Corn Stover: 2008 State of Technology Model*. Report No. NREL/TP-510-46214. Golden, CO: National Renewable Energy Laboratory, July 2009. <http://www.nrel.gov/docs/fy09osti/46214.pdf>.
  22. Wooley, R; Putsche, V. *Development of an ASPEN PLUS Physical Property Database for Biofuels Components*. Report No. NREL/MP-425-20685. Golden, CO: National Renewable Energy Laboratory, April 1996. <http://biodev.nrel.gov/pdfs/3955.pdf>.

23. Wooley, R.; Ibsen, K.; Putsche, V. *Development of an ASPEN PLUS Physical Property Database for Biofuels Components*. NREL Technical Memo, Document #4141. Golden, CO: National Renewable Energy Laboratory, 1999. <http://biodev.nrel.gov/bcfcdoc/4141.pdf>.
24. Hess, J.R.; Kenney, K.L.; Ovard, L.P.; Searcy, E.M.; Wright, C.T. *Uniform-Format Solid Feedstock Supply System: A Commodity-Scale Design to Produce an Infrastructure-Compatible Bulk Solid from Lignocellulosic Biomass, Section 3: Pioneer Uniform Feedstock Supply System*. Report No. INL/EXT-08-14752. Idaho Falls, ID: Idaho National Laboratory, 2009. <http://www.inl.gov/bioenergy/uniform-feedstock>.
25. Templeton, D.W.; Sluiter, A.D.; Hayward, T.K.; Hames, B.R.; Thomas, S.R. "Assessing Corn Stover Composition and Sources of Variability via NIRS." *Cellulose*; Vol. 16, 2009; pp. 621-639.
26. Corn stover analysis, sample 33A14 from Kramer Farm, Wray Pioneer Lot. Huffman Report #123409. Wray, CO: Kramer Farm.
27. Office of the Biomass Program, Energy Efficiency and Renewable Energy, U.S. Department of Energy. *Multi-Year Program Plan*. Washington, DC: U.S. Department of Energy, April 2011.
28. Chen, S.F.; Mowery, R.A.; Scarlata, C.J.; Chambliss, C.K. "Compositional Analysis of Water-Soluble Materials in Corn Stover." *J. Agric. Food Chem.*; Vol. 55, 2007; pp. 5912-5918.
29. Bower, S.; Wickramasinghe, R.; Nagle, N.J.; Schell, D.J. "Modeling Sucrose Hydrolysis in Dilute Sulfuric Acid Solutions at Pretreatment Conditions for Lignocellulosic Biomass." *Biores. Technol.*; Vol. 99, 2008; pp. 7354-7362.
30. Ethanol (data page).  
Wikipedia, [http://en.wikipedia.org/wiki/Ethanol\\_%28data\\_page%29](http://en.wikipedia.org/wiki/Ethanol_%28data_page%29).
31. Nagle, N.; Weiss, N.; Kuhn, E.; Tucker, M.; Sievers, D.; Elander, R. *Validate > 75% Xylan Yield and <8% Degradation from Whole Corn Stover using a High Solids Continuous Pretreatment Reactor*. D Milestone Report, Document #10341. Golden, CO: National Renewable Energy Laboratory, 2008. <http://biodev.nrel.gov/bcfcdoc/10341.pdf>.
32. Jennings, E.; Mohagheghi, A.; Schell, D.; Dowe, N. *Technical and Economic Performance of an Ammonium Hydroxide-Based Conditioning Technology*. E Milestone Report, Document #10379. Golden, CO: National Renewable Energy Laboratory, November 2008. <http://biodev.nrel.gov/bcfcdoc/10379.pdf>.
33. Jechura, J. *Correlation of Metal Corrosion Data*. NREL Technical Memo, Document #5194. Golden, CO: National Renewable Energy Laboratory, March 2001. <http://biodev.nrel.gov/bcfcdoc/5194.pdf>.

34. Humbird, D. *FY 2009 State of Technology Update—Biochem*. D Milestone, Document #10590. Golden, CO: National Renewable Energy Laboratory, October 2009. <http://biodev.nrel.gov/bcfcdoc/10590.pdf>.
35. Humbird, D. *FY 2010 Biochemical Platform State of Technology Update*. D Milestone, Document #10752. Golden, CO: National Renewable Energy Laboratory, September 2010. <http://biodev.nrel.gov/bcfcdoc/10752.pdf>.
36. Weiss, N.; Nagle, N.; Elander, R.; Tucker, M. *Achieve 75% Xylose Yield in Laboratory Scale High Solids Pretreatment Reactor on Corn Stem Internode*. D Milestone Report, Document #9926. Golden, CO: National Renewable Energy Laboratory, 2007. <http://biodev.nrel.gov/bcfcdoc/9926.pdf>.
37. Sievers, D.; Kuhn, E.; Nagle, N.; Tucker, M.; Weiss, N. *Implement Equipment Modifications to the Existing Horizontal Pretreatment Reactor System to Allow for Operation with a Tighter Residence Time Distribution*. D Milestone Report, Document #10404. Golden, CO: National Renewable Energy Laboratory, December 2008. <http://biodev.nrel.gov/bcfcdoc/10404.pdf>.
38. Nagle, N.; Kuhn, E.; Sievers, D.; Tucker, M.; Weiss, N.; Elander, R. *Parametric Study using the Continuous Horizontal Pretreatment Reactor using Corn Stover to Determine Operating Conditions that Achieve 80% Yield of Monomeric Xylose*. D Milestone Report, Document #10575 Golden, CO: National Renewable Energy Laboratory, September 2009. <http://biodev.nrel.gov/bcfcdoc/10575.pdf>.
39. Nagle, N.; Kuhn, E.; Elander, R. *Parametric Study Using the Modified Continuous Horizontal Pretreatment Reactor Using Corn Stover to Determine Operating Conditions that Can Achieve Yields of  $\geq 85\%$  of Monomeric Xylose*. NREL D Milestone Report, Document #10764 Golden, CO: National Renewable Energy Laboratory, September 2010. <http://biodev.nrel.gov/bcfcdoc/10764.pdf>.
40. Selig, M; Decker, S. *Enzymatic Conversion of Oligosaccharides from Various Pretreatment Hydrolysates*. Joule Milestone Report, Document #10114. Golden, CO: National Renewable Energy Laboratory, March 2008. <http://biodev.nrel.gov/bcfcdoc/10114.pdf>.
41. Humbird, D.; Elander, R. *Develop Process Engineering Scenarios for Potential Leading Pretreatment/Enzymatic Hydrolysis Configurations*. E Milestone Report, Document #10582. Golden, CO: National Renewable Energy Laboratory, September 2009. <http://biodev.nrel.gov/bcfcdoc/10582.pdf>.
42. Zhang, M.; Eddy, C.; Deanda, K.; Finkelstein, M.; Picataggio, S. "Metabolic Engineering of a Pentose Metabolism Pathway in *Zymomonas mobilis*." *Science*; Vol. 267, 1995; pp. 240-243.
43. Miroslav, S; Ho, N. "Production of ethanol from cellulosic biomass hydrolysates using genetically engineered *saccharomyces* yeast capable of cofermenting glucose and xylose," *Applied Biochemistry and Biotechnology*; Vol. 144, 2004; pp. 403-416.

44. “Integrated Biorefinery Research Facility.” National Renewable Energy Laboratory website, [http://www.nrel.gov/biomass/integrated\\_biorefinery\\_research\\_facility.html](http://www.nrel.gov/biomass/integrated_biorefinery_research_facility.html).
45. Humbird, D.; Mohagheghi, A.; Dowe, N.; Schell, D. “Economic Impact of Total Solids Loading on Enzymatic Hydrolysis of Dilute-Acid Pretreated Corn Stover.” *Biotechnology Progress*; Vol. 26, 2010; pp.1245-1251.
46. Loos, H.; Kramer, R.; Sahm, H.; Sprenger, G. “Sorbitol Promotes Growth of *Zymomonas mobilis* in Environments with High Concentrations of Sugar: Evidence for a Physiological Function of Glucose-Fructose Oxidoreductase in Osmoprotection.” *J. Bact.*; Vol. 179, 1994; pp. 7688-7693.
47. Dowe, N.; Humbird, D.; Schell, D. *Status Report on Overall Corn Stover to Ethanol Yield Improvement Effort*. Joule Milestone, Document #10457. Golden, CO: National Renewable Energy Laboratory, March 2009. <http://biodev.nrel.gov/bcfcdoc/10457.pdf>.
48. Franden, M.A.; Zhang, M. *Characterize Hydrolyzate Toxicity Across a Variety of Hydrolyzates Obtained from the Horizontal Pretreatment Reactor and Other Selected Process Relevant Hydrolyzates Using both Biological and Chemical Analysis*. D Milestone, Document #10585. Golden, CO: National Renewable Energy Laboratory, September 2009. <http://biodev.nrel.gov/bcfcdoc/10585.pdf>.
49. “Enzyme Systems Solicitation.” Financial Opportunities: Past Solicitations. Washington, DC: U.S. Department of Energy, Energy Efficiency and Renewable Energy website, 2008. [http://www1.eere.energy.gov/biomass/past\\_solicitations.html#Enzymes](http://www1.eere.energy.gov/biomass/past_solicitations.html#Enzymes).
50. “Ethanologen Projects—Development of Fermentative Microorganisms.” Financial Opportunities: Past Solicitations. Washington, DC: U.S. Department of Energy, Energy Efficiency and Renewable Energy website, 2007. [http://www1.eere.energy.gov/biomass/past\\_solicitations.html#Ethanologen\\_Projects](http://www1.eere.energy.gov/biomass/past_solicitations.html#Ethanologen_Projects).
51. Schell, D.; Humbird, D.; Wolfrum, E.; Zhang, M. *Research Plan for Demonstrating the 2012 Cost Target*. E Milestone, Document #10458. Golden, CO: National Renewable Energy Laboratory, March 2009. <http://biodev.nrel.gov/bcfcdoc/10458.pdf>.
52. “Ethanol Co-Products.” Ethanol Information website, <http://ethanol-information.com/ethanol-coproducts.php>.
53. Meerman, H.J.; Kelley, A.S.; Ward, M. “Advances in Protein Expression in Filamentous Fungi,” Chapter 7. Baneyx, F., ed. *Protein Expression Technologies: Current Status and Future Trends*. Norfolk, UK: Horizon Bioscience, 2004; p 345.
54. Warzywoda, M., et al., U.S. Patent No. 4,762,788, 28 November 1984.
55. Emme, B., Novozymes, Inc., personal communication with David Humbird, 2009.

56. Atkinson, B.; Mavituna, F. *Biochemical Engineering and Biotechnology Handbook*. New York: The Nature Press, 1983.
57. Wang, D.; Cooney, C.; Demain, A.; Dunnill, P.; Humphrey, A.; Lilly, M. *Fermentation and Enzyme Technology*. New York: John Wiley & Sons, 1979.
58. Schell, D.; Riley, C.; Bergeron, P.; Walter, P. *Technical and Economic Analysis of an Enzymatic Hydrolysis Based Ethanol Plant – Draft*. SERI Technical Report TP-232-4295. Golden, CO: Solar Energy Research Institute, 1991. <http://biodev.nrel.gov/bcfcdoc/3892.pdf>.
59. Jechura, J. *Sugar Platform Post Enzyme Subcontract Case*. Technical Memo, Document #9382 Golden, CO: National Renewable Energy Laboratory, October 2005. <http://biodev.nrel.gov/bcfcdoc/9382.pdf>.
60. Merino, S.T.; Cherry, J. “Progress and Challenges in Enzyme Development for Biomass Utilization.” *Adv. Biochem. Engin./Biotechnol.*; Vol. 108, 2007; pp. 95-120.
61. Dean, D.; Dodge, T.; Valle, F.; Chotani, G. “Development of biorefineries—technical and economic considerations.” Kamm, B. et al., ed. *Biorefineries—industrial processes and products. Status quo and future directions*. Vol. 1, Weinheim, Germany: Wiley-VCH, 2006; pp. 67–83.
62. “New Enzymes Turn Waste into Fuel.” Press release. Novozymes, Inc., February 15, 2010. <http://novozymes.com/en/news/news-archive/Pages/45713.aspx>.
63. “Genencor Introduces Accellerase DUET.” Press release. Genencor, February 15, 2010. [http://www.genencor.com/wps/wcm/connect/genencor/genencor/media\\_relations/news/archive/2010/pressrelease\\_509\\_en.htm](http://www.genencor.com/wps/wcm/connect/genencor/genencor/media_relations/news/archive/2010/pressrelease_509_en.htm).
64. Ahmetović, E.; Martin, M.; Grossman, I.E. “Optimization of energy and water consumption in corn-based ethanol plants,” *Ind. Eng. Chem. Res.*; Vol. 49, 2010; pp. 7972-7982.
65. Brown and Caldwell for Harris Group Inc. *Process Design of Wastewater Treatment for the NREL Cellulosic Ethanol Model*. Work performed by Harris Group Inc., Seattle, WA, under NREL Subcontract RGB-0-40607. Golden, CO: National Renewable Energy Laboratory, February 2011.
66. Mohagheghi, A.; Ruth, M.; Schell, D. “Conditioning Hemicellulosic Hydrolysates for Fermentation: Effects of Overliming pH on Sugar and Ethanol Yields.” *Process Biochemistry*; Vol. 41, 2006; pp. 1806-1811.
67. Reaction Engineering International. *Steam and Electricity Generation Options for the Biomass-To-Ethanol Process*. Work performed by Reaction Engineering International, Salt Lake City, UT, under NREL Subcontract ACO-8-18019-01. Golden, CO: National Renewable Energy Laboratory, March 1998.



68. Philippek, C.; Knöbig, T.; Schönfelder, H.; Werther, J. "NO<sub>x</sub> Formation and Reduction During Combustion of Wet Sewage Sludge in the Circulating Fluidized Bed." *Proceedings of the 14<sup>th</sup> International Conference on Fluidized Bed Combustion*; Vol. 2, New York: ASME Press, 1997.
69. Chemical Engineering Magazine Plant Cost Index. *Chemical Engineering Magazine*. <http://www.che.com/pci/>.
70. SRI Consulting. "U.S. Producer Price Indexes – Chemicals and Allied Products/Industrial Inorganic Chemicals Index." *Chemical Economics Handbook*. Menlo Park, CA: SRI Consulting, October 2008.
71. "National Employment, Hours, and Earnings Catalog, Industry: Chemicals and Allied Products." Bureau of Labor Statistics Data website, Series ID: CEU3232500008, Years 1980-2009, annual average. <http://data.bls.gov/cgi-bin/srgate>.
72. North American Electric Reliability Corporation. "Wholesale Average Electricity Price Table." U.S. Energy Information Administration website, <http://www.eia.doe.gov/cneaf/electricity/wholesale/wholesale.html>.
73. Garrett, D.E. *Chemical Engineering Economics*. New York: Van Nostrand Reinhold, 1989.
74. Peters, M.S.; Timmerhaus, K.D. *Plant Design and Economics for Chemical Engineers*. 5th Ed., New York: McGraw-Hill, 2003.
75. Chem Systems. *Biomass to Ethanol Process Evaluation*. NREL Final Subcontract Report. Work performed by Chem Systems, Tarrytown, NY. Golden, CO: National Renewable Energy Laboratory, December 1994. <http://biodev.nrel.gov/pdfs/3925.pdf>.
76. Walas, S.M. *Chemical Process Equipment - Selection and Design*. Newton, MA: Butterworth Heinemann, 1988.
77. Cran, J. "Improved factored method gives better preliminary cost estimates." *Chemical Engineering*, April 6, 1981; pp. 65-79.
78. "Sugar and Sweeteners Yearbook Tables: Excel Spreadsheets." Table 7—U.S. wholesale list price for glucose syrup, Midwest markets, monthly, quarterly, and by calendar and fiscal year. United States Department of Agriculture Economic Research Service website, <http://www.ers.usda.gov/Briefing/Sugar/data.htm#yearbook>. Direct download link for Table 7: <http://www.ers.usda.gov/Briefing/Sugar/Data/TABLE07.XLS>.
79. Urbanchuck, J. *Contribution of the Ethanol Industry to the Economy of the United States*. Prepared by LECG, LLC for the Renewable Fuels Association, 2008.
80. SRI Consulting. *PEP Yearbook*. Menlo Park, CA: SRI Consulting, 2008. <http://www.sriconsulting.com/>.

81. Short, W.; Packey, D.J.; Holt, T. *A Manual for the Economic Evaluation and Energy Efficiency and Renewable Energy Technologies*. Report No. TP-462-5173. Golden, CO: National Renewable Energy Laboratory, March 1995.
82. Internal Revenue Service. *How to Depreciate Property*. Publication #946. Washington, DC: Department of the Treasury Internal Revenue Service, 2009. <http://www.irs.gov/pub/irs-pdf/p946.pdf>.
83. Perry, R.H.; Green, D.W. *Perry's Chemical Engineers' Handbook*. 7th Ed., New York: McGraw-Hill, 1997.
84. Gary, J.H.; Handwerk, G.E. *Petroleum Refining, Technology and Economics*. 3rd Ed., New York: Marcel Dekker, Inc., 1994.
85. Macknick, J.; Newmark, R.; Heath, G.; Hallet, K.C. *A Review of Operational Water Consumption and Withdrawal Factors for Electricity Generating Technologies*. Report No. NREL/TP-6A20-50900. Golden, CO: National Renewable Energy Laboratory, March 2011. <http://www.nrel.gov/docs/fy11osti/50900.pdf>.
86. Dutta, A.; Ibsen, K.; Dowe, N. *Complete Integrated Tests of Pretreatment and Enzymatic Hydrolysis in Conjunction with Existing Fermentation Organisms at Bench-Scale on Corn Stover that Validate \$0.125 per Pound Sugars on the Pathway to Achieving \$0.064 per Pound in 2012*. Joule Milestone Report. Golden, CO: National Renewable Energy Laboratory, September 2007. <http://devafdc.nrel.gov/bcfcdoc/9985.pdf>. Rev. February 2008. <http://devafdc.nrel.gov/bcfcdoc/10087.pdf>.
87. Humbird, D. *Demonstrate Alternative Pretreatment Technologies at Bench-Scale using Advanced Cellulase Enzymes and Integrated Technologies that have the Potential of Achieving \$0.12/lb Sugar on the Pathway to \$0.073/lb by 2012 (in 2007\$)*. Joule Milestone Report, Document #10572. Golden, CO: National Renewable Energy Laboratory, September 2009. <http://biodev.nrel.gov/bcfcdoc/10572.pdf>.
88. "Natural Gas Prices." U.S. Energy Information Administration website, [http://tonto.eia.doe.gov/dnav/ng/ng\\_pri\\_sum\\_a\\_EPG0\\_PIN\\_DMcf\\_a.htm](http://tonto.eia.doe.gov/dnav/ng/ng_pri_sum_a_EPG0_PIN_DMcf_a.htm).
89. Keller and Heckmann LLP. *Assessment Plan for Corn Steep Liquor (CAS #66071-94-1) in Accordance with the USEPA High Production Volume Chemical Challenge Program*. Prepared for The Corn Refiners Association, 2006.
90. Verevkin, S.P.; Emel'yanenko V.N; Stepurko, E.N.; Ralys, R.V.; Zaitsau, D.H.; Stark, A. "Biomass-derived platform chemicals: Thermodynamic studies on the conversion of 5-hydroxymethylfurfural into bulk intermediates." *Ind. Eng. Chem. Res.*; Vol. 48, 2009; pp. 10087-10093.
91. Lewis Sr., R.J. (2007). *Hawley's Condensed Chemical Dictionary*. 15th Ed., New York: John Wiley & Sons, 2007.



92. Merrill, A.L.; Watt, B.K. *Energy Value of Foods: Basis and Derivation*. USDA ARS Handbook #74, 1973. <http://www.ars.usda.gov/SP2UserFiles/Place/12354500/Data/Classics/ah74.pdf>.
93. Roels, J.A. *Energetics and Kinetics in Biotechnology*. Amsterdam: Elsevier Biomedical Press, 1983.
94. Bailey, J.E.; Ollis, D.F. *Biochemical Engineering Fundamentals*. 2nd Ed., New York: McGraw-Hill, 1986.

## **Appendix A. Individual Equipment Costs Summary**

The left side of the following table shows abbreviated specifications and the purchased cost for each piece of equipment in the PFDs. The right side of the table shows the calculations used to scale the purchased cost for size and installation. Although each piece of equipment has its own line, many were quoted as part of a package so their scaling calculations are grayed out. Note that the package prices are generally listed on the first associated line-item.

NREL and Harris Group would like to acknowledge the equipment vendors who assisted us with the cost estimation effort for this design report.

Mechanical Equipment List								Scaled Installed Costs										
EQPT NO	EQUIPMENT TITLE	VENDOR	DESCRIPTION	HP	MATERIAL	NUM REQD	\$	Year of Quote	Scaling Variable	Scaling Val	Units	Scaling Exp	Inst Factor	New Val	Size Ratio	Scaled Purch Cost	Purch Cost in Proj year	Inst Cost in Proj year
C-101	Transfer Conveyor	Dearborn Midwest	160 MTPH ea., enclosed, 60 in. x 65 ft. long	20 hp ea.	CS	2	\$5,397,000	2009	STRM.101	94697	kg/hr	0.60	1.7	104167	1.10	\$5,714,628	\$5,752,952	\$9,780,018
C-102	High Angle Transfer Conveyor	Dearborn Midwest	160 MTPH ea., enclosed, 72 in. wide	50 hp ea.	CS	2	INCLUDED											
C-103	Reversing Load-in Conveyor	Dearborn Midwest	320 MT / hr, enclosed, 84 in. wide	20 hp	CS	1	INCLUDED											
C-104	Dome Reclaim System	Cambelt	100 MTPH ea.	45 kw ea.	CS	2	\$3,046,000	2009	STRM.101	94697	kg/hr	0.60	1.7	104167	1.10	\$3,225,265	\$3,246,895	\$5,519,721
C-105	Reclaim Conveyor	Dearborn Midwest	100 MTPH ea., enclosed, 48 in. x 125 ft. long	10 hp ea.	CS	2	INCLUDED											
C-106	High Angle Transfer Conveyor	Dearborn Midwest	100 MTPH, enclosed, 72 in. wide	20 hp	CS	1	INCLUDED											
C-107	Elevated Transfer Conveyor	Dearborn Midwest	100 MTPH, enclosed, 48 in. x 200 ft. long	10 hp	CS	1	INCLUDED											
C-108	Process Feed Conveyor	Dearborn Midwest	70 MTPH ea., enclosed, 42 in. x 25 ft. long	5 hp ea.	CS	1	INCLUDED											
M-101	Truck Scale	St. Louis Scale	10' x 70', 200,000 lb		CONCRETE	2	\$110,000	2009	STRM.101	94697	kg/hr	0.60	1.7	104167	1.10	\$116,474	\$117,255	\$199,333
M-102	Truck Dumper	Jeffrey Rader	70' x 55 ton x 63 degree	2 x 50 hp	CS	2	\$484,000	2009	STRM.101	94697	kg/hr	0.60	1.7	104167	1.10	\$512,485	\$515,922	\$877,067
M-103	Truck Dumper Hopper	Jeffrey Rader	3500 cu.ft. hopper w/ drag chain conveyor	50 hp ea.	CS	2	\$502,000	2009	STRM.101	94697	kg/hr	0.60	1.7	104167	1.10	\$531,544	\$535,109	\$909,685
M-104	Concrete Feedstock Storage Dome	Domtec	98 ft. dia., 160 ft. high., 4000 MT		CONCRETE	2	\$3,500,000	2009	STRM.101	94697	kg/hr	0.60	1.7	104167	1.10	\$3,705,984	\$3,730,838	\$6,342,424
M-105	Belt Scale	Tecweigh	Scale plus processor		CS	2	\$10,790	2009	STRM.101	94697	kg/hr	0.60	1.7	104167	1.10	\$11,425	\$11,502	\$19,553
M-106	Dust Collection System	Sly	8500 ACFM	25 hp ea.	CS	6	\$279,900	2009	STRM.101	94697	kg/hr	0.60	1.7	104167	1.10	\$296,373	\$298,360	\$507,213
<b>Area 100 Totals</b>																<b>\$14,114,178</b>	<b>\$14,208,831</b>	<b>\$24,155,013</b>

Mechanical Equipment List								Scaled Installed Costs										
EQPT NO	EQUIPMENT TITLE	VENDOR	DESCRIPTION	HP	MATERIAL	NUM REQD	\$	Year of Quote	Scaling Variable	Scaling Val	Units	Scaling Exp	Inst Factor	New Val	Size Ratio	Scaled Purch Cost	Purch Cost in Proj year	Inst Cost in Proj year
A- 201	In-line Sulfuric Acid Mixer	KOMAX	Kynar Lined - 600 gpm H2O - 5 gpm acid		SS304	1	\$6,000	2009	strm.a200.214	136260	kg/hr	0.50	1.0	38801	0.28	\$3,202	\$3,223	\$3,223
A- 203	Blowdown Tank Agitator	Andritz	Side-mounted, 3 x 75 hp. ( 170 kW)	170 kW	316LSS	1	INCLUDED											
A- 204	Flash Tank Agitator	UET Mixers	Side-mounted, 3 x 75 hp. ( 170 kW)	170 kW	316LSS	3	\$90,000	2009	strm.a200.254	252891	kg/hr	0.50	1.5	278194	1.10	\$94,395	\$95,028	\$142,542
A- 208	Oligomer Hold Tank Agitator	UET Mixers	Side-mounted, 3 x 75 hp. ( 170 kW)	170 kW	316LSS	3	\$90,000	2009	strm.a200.222	264116	kg/hr	0.50	1.5	292060	1.11	\$94,641	\$95,276	\$142,914
A- 209	Ammonia Addition Tank Agitator	Lotus		10 hp	SS	1	\$21,900	2009	strm.a200.228	410369	kg/hr	0.50	1.5	429554	1.05	\$22,406	\$22,556	\$33,835
A- 210	Ammonia Static Mixer	KOMAX			SS	1	\$5,000	2009	strm.a200.275	157478	kg/hr	0.50	1.0	151360	0.96	\$4,902	\$4,935	\$4,935
A- 224	Reacidification Tank Agitator	Lotus		20 hp	SS	1	\$0	2009	strm.a200.239	410846	kg/hr	0.50	1.5	429554	1.05	\$0	\$0	\$0
C- 201	Transfer Conveyor	Andritz	800 mm x 7600 mm (2'-8" x 25')	40 kW ea.	AL-6XN	2	INCLUDED											
C- 202	Distribution Conveyor	Andritz	800 mm x 7600 mm (2'-8" x 25')	40 kW ea.	AL-6XN	2	INCLUDED											
C- 203	Overfeed Conveyor	Andritz	800 mm x 7600 mm (2'-8" x 25')	40 kW ea.	AL-6XN	4	INCLUDED											
C- 204	Pressurized Heating Screw	Andritz	2500 mm x 9500 mm (8' x 31')	75 kW	Dup. 2205	1	INCLUDED											
C- 205	Pressurized Pre-heater Discharge	Andritz	850 mm x 3500 mm (2'-10" x 12')	40 kW ea.	Dup. 2205	2	INCLUDED											
C- 206	Pressurized Transport - No. 1	Andritz	900 mm x 3500 mm (3' x 12')	20 kW	Incoloy 825-CLAD; CS	1	INCLUDED											
C- 207	Pressurized Transport - No. 2	Andritz	1200 mm x 3500 mm (4' x 12')	40 kW	Incoloy 825-CLAD; CS	1	INCLUDED											
H- 201	Pretreatment Water Heater	Mueller	29.9 MMBtu		304SS	1	\$92,000	2010	Heat.A200.QH201	-8	Gcal/hr	0.70	2.2	-9	1.15	\$101,545	\$97,091	\$213,600
H- 244	Waste Vapor Condenser	Mueller	Copied H-201		304SS	1	\$34,000	2009	Heat.A200.QH244	2	Gcal/hr	0.70	2.2	7	3.98	\$89,346	\$89,946	\$197,880
M- 201	Doffing Roll Storage Bins	Andritz	60 cu. m. (2100 cu.ft.) with conveyors/scrappers	40 kW ea.	304/316SS	2	INCLUDED											
M- 202	Pin Drum Feeder	Andritz		15 kW ea.	316LSS	2	INCLUDED											
M- 203	Plug Screw Feeder	Andritz		1100kW ea.	316LSS	2	INCLUDED											
M- 204	Prehydrolysis / Vertical Preheater	Andritz	16' x 62' - 10 min. residence time	45 kW	Dup. 2205	1	INCLUDED											
M- 205	Pin Drum Feeder	Andritz		15 kW ea.	Incoloy 825-CLAD; CS	2	INCLUDED											
M- 206	Plug Screw Feeder	Andritz		1100 kW ea.	Incoloy 825-CLAD; CS	2	INCLUDED											
M- 207	Pretreatment Reactor	Andritz	2600 mm x 9000 mm (9' x 30') - 2 min. residence time		Incoloy 825-CLAD; CS	3	\$19,812,400	2009	DRY101	83333	kg/hr	0.60	1.5	83333	1.00	\$19,812,448	\$19,945,315	\$29,917,973
P- 201	Sulfuric Acid Pump	Goulds	9 GPM, 245 FT TDH		316SS	1	\$8,000	2009	strm.710	3720	kg/hr	0.80	2.3	1981	0.53	\$4,832	\$4,864	\$11,187
P- 203	Blowdown Tank Discharge Pump	Viking	1900 GPM, 150 FT TDH	125	316SS	1	\$25,635	2010	strm.a200.222	292407	kg/hr	0.80	2.3	292060	1.00	\$25,611	\$24,487	\$56,321
P- 204	Flash Tank Discharge Pump	Viking	900 GPM, 150 FT TDH	75	316SS	1	\$30,000	2009	strm.a200.254	204390	kg/hr	0.80	2.3	278194	1.36	\$38,391	\$38,649	\$88,892
P- 208	Oligomer Hold Tank Discharge	Viking	900 GPM, 150 FT TDH	75	316SS	1	\$17,408	2010	strm.a200.223	292407	kg/hr	0.80	2.3	292060	1.00	\$17,391	\$16,629	\$38,246
P- 209	Hydrolyzate Pump	Goulds	1771 GPM, 150 FT TDH	100	316SS	1	\$22,500	2009	strm.a200.228	402194	kg/hr	0.80	2.3	429554	1.07	\$23,716	\$23,875	\$54,913
P- 239	Reacidified Hydrolyzate Pump	Goulds	1771 GPM, 100 FT TDH	60	316SS	1	\$0	2009	strm.a200.239	402194	kg/hr	0.80	2.3	429554	1.07	\$0	\$0	\$0
S- 205	Hydrolyzate Solid-Liquid Separator	Larox					\$35,000,000	2009	scis.a200.254b	39000	kg/hr	0.70	1.7	0	0.00	\$0	\$0	\$0
T- 201	Sulfuric Acid Tank		12,800 gal, 24hr residence time		PLASTIC	1	\$6,210	2010	strm.710	1981	kg/hr	0.70	3.0	1981	1.00	\$6,209	\$5,937	\$17,810
T- 203	Blowdown Tank	Andritz	23' x 48' - 25 min. - 110,000 gal.		SS316	1	INCLUDED											
T- 204	Flash Tank		23' x 48' - 110,000 gal.		SS316	1	\$511,000	2009	strm.a200.223	264116	kg/hr	0.70	2.0	292060	1.11	\$548,271	\$551,948	\$1,103,895
T- 208	Oligomer Conversion Tank		2.6 atm, 130C operating 30 min. hold = 30,000 gal		SS316	1	\$203,000	2009	strm.a200.223	264116	kg/hr	0.70	2.0	292060	1.11	\$217,806	\$219,267	\$438,534
T- 209	Ammonia Addition Tank		118,000 gal, 1hr residence time		SS304	1	\$236,000	2009	strm.a200.228	410369	kg/hr	0.70	2.0	429554	1.05	\$243,670	\$245,304	\$490,609
T- 224	Reacidification Tank	Mueller	500,000 gallon		SS304	1	\$0	2009	strm.a200.239	410369	kg/hr	0.70	2.0	429554	1.05	\$0	\$0	\$0
<b>Area 200 Totals</b>																<b>\$21,348,782</b>	<b>\$21,484,330</b>	<b>\$32,957,310</b>

Mechanical Equipment List										Scaled Installed Costs								
EQPT NO	EQUIPMENT TITLE	VENDOR	DESCRIPTION	HP	MATERIAL	NUM REQD	\$	Year of Quote	Scaling Variable	Scaling Val	Units	Scaling Exp	Inst Factor	New Val	Size Ratio	Scaled Purch Cost	Purch Cost in Proj year	Inst Cost in Proj year
A- 300	Ethanol Fermentor Agitator	Lotus		30 hp	SS304	1	\$52,500	2009	inumsscf		1 ea	1.00	1.5	12	12	\$630,000	\$634,225	\$951,337
A- 301	Seed Hold Tank Agitator	Lotus		15 hp	SS304	1	\$31,800	2009	STRM.A300.304	40414	kg/hr	0.50	1.5	42607	1.05	\$32,651	\$32,870	\$49,305
A- 304	4th Seed Vessel Agitator	Lotus		7.5 hp	SS	2	\$26,000	2009			2 ea	0.50	1.5	2	1.00	\$26,000	\$26,174	\$39,262
A- 305	5th Seed Vessel Agitator	Lotus		10 hp	SS	2	\$43,000	2009			2 ea	0.50	1.5	2	1.00	\$43,000	\$43,288	\$64,933
A- 306	Beer Surge Tank Agitator	Lotus		20 hp	SS304	2	\$68,300	2009	strm.501	425878	kg/hr	0.50	1.5	450740	1.06	\$70,265	\$70,737	\$106,105
A- 308	Enzyme-Hydrolysate Mixer	GLV	inline mixer 1673 gpm	100 hp	SS316	1	\$109,000	2009	strm.a300.1310fd	379938	kg/hr	0.50	1.7	443391	1.17	\$117,751	\$118,540	\$201,519
F- 300	Ethanol Fermentor	Mueller	1,000,000 gallon ea		304SS	12	\$10,128,000	2009	inumsscf		12 ea	1.00	1.5	12	1.00	\$10,128,000	\$10,195,921	\$15,293,882
F- 301	1st Seed Fermentor	A&B Process	20 gallon skid complete - \$37,700 ea		304SS	2	\$75,400	2009			2 ea	0.70	1.8	2	1.00	\$75,400	\$75,906	\$136,630
F- 302	2nd Seed Fermentor	A&B Process	200 gallon skid complete - \$58,300 ea		304SS	2	\$116,600	2009			2 ea	0.70	1.8	2	1.00	\$116,600	\$117,382	\$211,288
F- 303	3rd Seed Fermentor	A&B Process	2000 gallon skid complete - \$78,800 ea		304SS	2	\$157,600	2009			2 ea	0.70	1.8	2	1.00	\$157,600	\$158,657	\$285,582
F- 304	4th Seed Fermentor	Mueller	20,000 gallon, incl. coil - \$176,000 ea		304SS	2	\$352,000	2009			2 ea	0.70	2.0	2	1.00	\$352,000	\$354,361	\$708,721
F- 305	5th Seed Fermentor	Mueller	200,000 gallon, incl. coil - \$590,000 ea		304SS	2	\$1,180,000	2009			2 ea	0.70	2.0	2	1.00	\$1,180,000	\$1,187,913	\$2,375,827
H- 300	Fermentation Cooler	Alfa Laval	Plate & frame		304SS	12	\$86,928	2009	inumsscf		12 ea	1.00	2.2	12	1.00	\$86,928	\$87,511	\$192,524
H- 301	Hydrolysate Cooler	Fox Engineering	Plate & Frame 32.5 MMBtu/hr		SS 304	1	\$85,000	2010	heat.a300.qc301		8 Gcal/hr	0.70	2.2	11	1.30	\$101,972	\$97,500	\$214,500
H- 304	4th Seed Fermentor Coil	Mueller	incl. w/ tank		304SS	1	INCLUDED											
H- 305	5th Seed Fermentor Coil	Mueller	incl. w/ tank		304SS	1	INCLUDED											
H- 310	Fermentor Batch Cooler	Alfa Laval	Plate & frame		SS304	1	\$23,900	2009	heat.a300.qf300sf		5 Gcal/hr	0.70	1.8	0.000	0.00	\$0	\$0	\$0
P- 300	Fermentation Recirc/Transfer Pump	Goulds	340 GPM, 150 FT	20	316SS	5	\$47,200	2009	inumsscf		12 ea	0.80	2.3	12	1.00	\$47,200	\$47,517	\$109,288
P- 301	Seed Hold Transfer Pump	Goulds	190 GPM, 150 FT TDH	10	316SS	1	\$8,200	2009	strm.a300.304	43149	kg/hr	0.80	2.3	42607	0.99	\$8,117	\$8,172	\$18,795
P- 302	Seed Transfer Pump	Goulds	190 GPM, 615 FT TDH	40	316SS	2	\$24,300	2009	strm.a300.304	43149	kg/hr	0.80	2.3	42607	0.99	\$24,055	\$24,217	\$55,998
P- 306	Beer Transfer Pump	Goulds	2152 GPM, 171 FT TDH	125	316SS	1	\$26,800	2009	strm.501	488719	kg/hr	0.80	2.3	450740	0.92	\$25,120	\$25,289	\$58,165
P- 310	Saccharification Transfer Pump	Goulds	352 GPM, 150 FT TDH	20	316SS	5	\$47,200	2009	strm.a300.306	421776	kg/hr	0.80	2.3	443391	1.05	\$49,125	\$49,455	\$113,746
T- 301	Seed Hold Tank	Mueller	300,000 gallon		316SS	1	\$439,000	2009	strm.a300.304	40414	kg/hr	0.70	1.8	42607	1.05	\$455,540	\$458,595	\$825,471
T- 306	Beer Storage Tank	Mueller	500,000 gallon		316SS	1	\$636,000	2009	strm.501	425878	kg/hr	0.70	1.8	450740	1.06	\$661,768	\$666,206	\$1,199,170
T- 310	Saccharification Tank	Caldwell	250,000 gal each - 19' dia. x 120' tall		304SS	8	\$3,840,000	2009	strm.a300.306	421776	kg/hr	0.70	2.0	443391	1.05	\$3,976,717	\$4,003,386	\$8,006,772
<b>Area 300 Totals</b>																<b>\$18,365,811</b>	<b>\$18,483,821</b>	<b>\$31,218,520</b>
A- 400	Cellulase Fermentor Agitators	Lotus		800.0	SS316		\$580,000	2009	CLVESSEL		1 ea	1.00	1.5	9	9.00	\$5,220,000	\$5,255,007	\$7,882,510
A- 401	Cellulase Fermentor Agitators	Lotus		0.75hp	SS316		\$3,420	2009	ICLSEED		1 ea	1.00	1.5	4	4.00	\$13,680	\$13,772	\$20,658
A- 402	Cellulase Fermentor Agitators	Lotus		8 hp	SS316		\$63,000	2009	ICLSEED		1 ea	1.00	1.5	4	4.00	\$252,000	\$253,690	\$380,535
A- 403	Cellulase Fermentor Agitators	Lotus		80 hp	SS316		\$11,000	2009	ICLSEED		1 ea	1.00	1.5	4	4.00	\$44,000	\$44,295	\$66,443
A- 405	Media-Prep Tank Agitator	Lotus		7.5 hp	A285C	1	\$8,500	2009	strm.a400.402a	12255	kg/hr	0.50	1.5	0	0.00	\$0	\$0	\$0
A- 406	Cellulase Nutrient Mix Tank Agitator	Lotus		3 hp	CS	1	\$4,800	2009	strm.a400.416	174	kg/hr	0.50	1.6	224	1.29	\$5,446	\$5,482	\$8,772
A- 410	Cellulase Hold Tank Agitator	Lotus		10 hp	SS316	1	\$26,900	2009	strm.422	10930	kg/hr	0.50	1.5	13836	1.27	\$30,266	\$30,469	\$45,703
F- 400	Cellulase Fermentor	Mueller	80,000 gal, 1 atm, 28 °C, Internal coil		SS316		\$400,500	2009	CLVESSEL		1 ea	1.00	2.0	9	9.00	\$3,604,500	\$3,628,673	\$7,257,345
F- 401	1st Cellulase Seed Fermentor	A&B Process	80 gallon skid complete - \$46,000 ea		304SS		\$46,000	2009	ICLSEED		1 ea	1.00	1.8	4	4.00	\$184,000	\$185,234	\$333,421
F- 402	2nd Cellulase Seed Fermentor	A&B Process	800 gallon skid complete - \$57,500 ea		304SS		\$57,500	2009	ICLSEED		1 ea	1.00	1.8	4	4.00	\$230,000	\$231,542	\$416,776
F- 403	3rd Cellulase Seed Fermentor	A&B Process	8,000 gallon skid complete - \$95,400 ea		304SS		\$95,400	2009	ICLSEED		1 ea	1.00	1.8	4	4.00	\$361,600	\$384,159	\$691,486
H- 400	Cellulase Fermentation Cooler	Mueller	Cooling coil included with Cellulase Fermentor		304SS		INCLUDED											
H- 405	Media Prep Tank Cooler	Mueller	Cooling coil included with Media Prep Tank		304SS	1	INCLUDED											
M-401	Fermenter Air Compressor Package	Dresser Roots	8000 SCFM @ 16 psig		CS	2	\$350,000	2009	strm.a400.450	33168	kg/hr	0.60	1.6	32583	0.98	\$346,282	\$348,604	\$557,767
P- 400	Cellulase Transfer Pump	Goulds	59 gpm, 100 FT, TDH SIZE 2X1-10C	3	316SS	1	\$7,357	2010	strm.a400.420	13399	kg/hr	0.80	2.3	13836	1.03	\$7,549	\$7,218	\$16,600
P- 401	Cellulase Seed Pump	Goulds	3 GPM, 100 FT TDH SIZE 2X1-10	2	316SS	4	\$29,972	2010	strm.a400.409	681	kg/hr	0.80	2.3	770	1.13	\$33,045	\$31,596	\$72,670
P- 405	Media Pump	Goulds	63 GPM, 100 FT TDH SIZE 2X1-10C	3	316SS	1	\$7,357	2010	strm.a400.402a	14307	kg/hr	0.80	2.3	0	0.00	\$0	\$0	\$0
P- 406	Cellulase Nutrient Transfer Pump	Viking	Gear Pump 2 GPM, 100 FT	1	316SS	1	\$1,500	2009	strm.a400.416	454	kg/hr	0.80	2.3	224	0.49	\$852	\$858	\$1,974
P- 410	Cellulase Feed Pump	Viking	Gear Pump	1	316SS	1	\$1,500	2009	strm.a400.422	18168	kg/hr	0.80	2.3	13836	0.76	\$4,584	\$4,615	\$10,614
P- 420	Anti-foam Pump	Viking	Gear Pump 2 GPM, 100 FT	1	316SS	1	\$1,500	2009	strm.a400.444	11	kg/hr	0.80	2.3	13.4	1.26	\$1,805	\$1,817	\$4,179
T- 401	SO2 Storage Tank	SO2 Vendor	1 ton cylinders, incl w/ delivery		SS304	1	\$0											
T- 405	Media-Prep Tank	Mueller	20,000 gallon, incl. coil		304SS	1	\$176,000	2009	strm.a400.402a	12255	kg/hr	0.70	1.8	0	0.00	\$0	\$0	\$0
T- 406	Cellulase Nutrient Mix Tank	Harrington	HDPE, 8,000 gal		HDPE	1	\$9,000	2010	strm.a400.416	224	kg/hr	0.70	3.0	224	1.00	\$9,000	\$8,605	\$25,815
T- 410	Cellulase Hold Tank	Mueller	80,000 gal		304SS	1	\$248,070	2009	strm.a400.422	10930	kg/hr	0.70	1.8	13836	1.27	\$292,589	\$294,551	\$530,192
<b>Area 400 Totals</b>																<b>\$10,661,197</b>	<b>\$10,730,186</b>	<b>\$18,323,460</b>

Mechanical Equipment List								Scaled Installed Costs										
EQPT NO	EQUIPMENT TITLE	VENDOR	DESCRIPTION	HP	MATERIAL	NUM REQD	\$	Year of Quote	Scaling Variable	Scaling Val	Units	Scaling Exp	Inst Factor	New Val	Size Ratio	Scaled Purch Cost	Purch Cost in Proj year	Inst Cost in Proj year
A- 530	Filtrate Tank Agitator	Lotus		7.5 hp	SS	1	\$26,000	2009	strm.a500.evap.572	337439	kg/hr	0.50	1.5	355024	1.05	\$26,669	\$26,848	\$40,272
C- 501	Lignin Wet Cake Conveyor	KWS/Barnard-Boe	Belt 100 ft. long x 24" wide, enclosed	10	SS304	1	\$70,000	2009	strm.a500.571	28630	kg/hr	0.80	1.7	36538	1.28	\$85,082	\$85,653	\$145,610
C- 502	Lignin Wet Cake Screw	KWS/Barnard-Boe	Screw conveyor - 25 ft lg x 14" dia	15	SS304	1	\$20,000	2009	strm.a500.571	28630	kg/hr	0.80	1.7	36538	1.28	\$24,309	\$24,472	\$41,603
D- 501	Beer Column	Megtec	14' dia. x 76' tall, 32 trays, 24" spacing		316SS	1	\$3,407,000	2009	strm.a500.511	30379	kg/hr	0.60	2.4	29213	0.96	\$3,327,914	\$3,350,232	\$8,040,557
D- 502	Rectification Column	Megtec	Top 13' dia. x 68' h, Bottom 4'6" x 31' h		316SS	1	INCLUDED											
H- 501	Beer Column Reboiler	Megtec	S & T		316SS;CS	1	INCLUDED											
H- 502	Rectification Column Reboiler	Megtec	S & T		316SS;CS	1	INCLUDED											
H- 504	Beer Column Condenser	Megtec	S & T		316SS;CS	1	INCLUDED											
H- 505	Rectification Column Condenser	GEA Rainey	92.2 MM Btu/hr 3 cells	300 tot	CS	1	\$487,000	2010	heat.a500.qcd502	23	Gcal/hr	0.60	2.8	23	1.00	\$486,746	\$465,399	\$1,303,116
H- 512	Beer Column Feed Interchanger	Megtec	Plate & Frame		316SS	1	INCLUDED											
M-503	Molecular Sieve Package (9 pieces)	Delta-T			SS	1	\$2,601,000	2009	strm.a500.515	22687	kg/hr	0.60	1.8	21808	0.96	\$2,540,057	\$2,557,091	\$4,602,764
M-505	Pressure Filter Pressing Compr	Atlas-Copco	460 SCFM, 300 psig	150 hp		1	\$75,200	2009	strm.a500.evap.sqairin	808	kg/hr	0.60	1.6	809	1.00	\$75,245	\$75,750	\$121,199
M-507	Pressure Filter Drying Compr	Atlas-Copco	4000 SCFM, 130 psig (ea)	700 hp ea.		2	\$405,000	2009	strm.a500.evap.557	12233	kg/hr	0.60	1.6	12105	0.99	\$402,453	\$405,152	\$648,243
P- 501	Beer Column Bottoms Recirc Pump	Megtec	10,000 gpm	200	316SS	1	INCLUDED											
P- 503	Beer Column Reflux Pump	Megtec	15 gpm	2	316SS	1	INCLUDED											
P- 504	Rectification Column Btms Pump	Megtec	150 gpm	15	316SS	1	INCLUDED											
P- 505	Rectification Column Reflux Pump	Megtec	500 gpm	50	316SS	1	INCLUDED											
P- 506	Beer Column Stillage Pump	Megtec	2000 gpm	75	316SS	1	INCLUDED											
P- 515	Scrubber Bottoms Pump	Goulds	108 GPM, 104 FT TDH		316SS	1	\$6,300	2009	strm.551	24527	kg/hr	0.80	2.3	27197	1.11	\$6,843	\$6,889	\$15,844
P- 530	Filtrate Tank Discharge Pump	Sulzer	590 GPM, 100 FT TDH SIZE 4X3-13		SS	1	\$13,040	2010	strm.a500.evap.571	31815	kg/hr	0.80	2.3	36538	1.15	\$14,567	\$13,928	\$32,035
P- 531	Feed Pump	Warman	1014 GPM 230 FT TDH SIZE 8X6-15	100 hp	SS	1	\$18,173	2010	strm.a500.evap.571	31815	kg/hr	0.80	2.3	36538	1.15	\$20,301	\$19,411	\$44,645
P- 532	Manifold Flush Pump	Warman		100 hp	SS	1	\$17,057	2010	strm.a500.evap.571	31815	kg/hr	0.80	2.3	36538	1.15	\$19,054	\$18,219	\$41,903
P- 533	Cloth Wash Pump	Warman		150 hp	SS	1	\$29,154	2010	strm.a500.evap.571	31815	kg/hr	0.80	2.3	36538	1.15	\$32,568	\$31,140	\$71,621
P- 581	Filtrate Discharge Pump	Sulzer	590 GPM, 100 FT TDH SIZE 4X3-13	75 hp	SS	1	\$13,040	2010	strm.a500.evap.571	31815	kg/hr	0.80	2.3	36538	1.15	\$14,567	\$13,928	\$32,035
S- 505	Pressure Filter	Larox	384 sq. m filtration area ea incl packing		SS316	2	\$3,294,700	2010	strm.a500.evap.571	31815	kg/hr	0.80	1.7	36538	1.15	\$3,680,519	\$3,519,098	\$5,982,467
T- 503	Beer Column Reflux Drum	Megtec	4' dia, 6' high, 50 psig design		316SS	1	INCLUDED											
T- 505	Rectification Column Reflux Drum	Megtec	4' dia, 6' high, 50 psig design		316SS	1	INCLUDED											
T- 512	Vent Scrubber	Envitech	Inlet Gas: 9681 acfm, 91°F, 1.97 mass% Ethanol		SS304;PP	1	\$215,000	2009	strm.a500.523	22608	kg/hr	0.60	2.4	21759	0.96	\$210,121	\$211,530	\$507,673
T- 530	Filtrate Tank		13,750 gal 14' dia x 12' H		SS	1	\$103,000	2010	strm.a500.evap.571	31815	kg/hr	0.70	2.0	36538	1.15	\$113,480	\$108,503	\$217,006
T- 531	Feed Tank		20,300 gal 14' dia x 18' H		SS	1	\$174,800	2010	strm.a500.evap.571	31815	kg/hr	0.70	2.0	36538	1.15	\$192,585	\$184,139	\$368,278
T- 532	Recycled Water Tank	Harrington Plastic	4000 gal.		HDPE	1	\$1,520	2010	strm.a500.evap.571	31815	kg/hr	0.70	3.0	36538	1.15	\$1,675	\$1,601	\$4,804
T- 533	Pressing Air Compressor Receiver		1350 gal., 300 psig design		CS	1	\$8,000	2010	strm.a500.evap.571	31815	kg/hr	0.70	3.1	36538	1.15	\$8,814	\$8,427	\$26,125
T- 534	Drying Air Compressor Receiver		9,000 gal., 150 psig design		CS	2	\$17,000	2010	strm.a500.evap.571	31815	kg/hr	0.70	3.1	36538	1.15	\$18,730	\$17,908	\$55,516
<b>Area 500 Totals</b>																<b>\$11,302,300</b>	<b>\$11,145,318</b>	<b>\$22,343,314</b>

Mechanical Equipment List										Scaled Installed Costs									
EQPT NO	EQUIPMENT TITLE	VENDOR	DESCRIPTION	HP	MATERIAL	NUM REQD	\$	Year of Quote	Scaling Variable	Scaling Val	Units	Scaling Exp	Inst Factor	New Val	Size Ratio	Scaled Purch Cost	Purch Cost in Proj year	Inst Cost in Proj year	
B-606	Biogas Blower	ADI	3000 ACFM, 10 PSI	200.0		4	INCLUDED												
B-608	Aerobic Digester Blower	ADI	14,000 SCFM @ 10.3 psig	1,000		8	\$1,933,750	2010	strm.a600.601	393100	kg/hr	0.60	1.0	411178	1.05	\$1,986,627	\$1,899,498	\$1,899,498	
C-614	Aerobic Sludge Screw				CS	1	\$25,000	2010	strm.a600.601	393100	kg/hr	0.60	1.0	411178	1.05	\$25,684	\$24,557	\$24,557	
H-602	Anaerobic Digester Feed Cooler	ALFA LAVAL	Wide gap plate & frame 2.5 mgd		SS316; CS	1	\$83,863	2010	strm.a600.601	393100	kg/hr	0.60	1.0	411178	1.05	\$86,156	\$82,378	\$82,378	
M-606	Biogas Emergency Flare	ADI				4	\$32,955	2010	strm.a600.601	393100	kg/hr	0.60	1.0	411178	1.05	\$33,856	\$32,371	\$32,371	
M-630	Polymer Addition System	ADI	11.4 gph neat polymer	10.0		1	\$9,300	2010	strm.a600.601	393100	kg/hr	0.60	1.0	411178	1.05	\$9,554	\$9,135	\$9,135	
M-632	Caustic Feed System	ADI	0-300 gph Aerobic Digesters #1- #3	1.5		3	\$22,800	2010	strm.a600.601	393100	kg/hr	0.60	1.0	411178	1.05	\$23,423	\$22,396	\$22,396	
M-640	Evaporator System						\$3,801,095	2010	strm.a600.601	393100	kg/hr	0.60	1.0	411178	1.05	\$3,905,034	\$3,733,767	\$3,733,767	
P-602	Anaerobic Reactor Feed Pump	ADI	2500 gpm submersible rail mounted	50.0	CS	4	\$231,488	2010	strm.a600.601	393100	kg/hr	0.60	1.0	411178	1.05	\$237,818	\$227,388	\$227,388	
P-606	Anaerobic Reactor Recirc Pump	ADI	400 gpm, 50 ft TDH	7.5		4	INCLUDED												
P-607	Waste Anaerobic Sludge Pump	ADI	10 gpm	3.0		6	\$93,300	2010	strm.a600.601	393100	kg/hr	0.60	1.0	411178	1.05	\$95,851	\$91,647	\$91,647	
P-608	Aeration Basin Feed Pump	ADI		15.0		4	\$84,000	2010	strm.a600.601	393100	kg/hr	0.60	1.0	411178	1.05	\$86,297	\$82,512	\$82,512	
P-609	Return Activated Sludge Pump	ADI		40.0		6	\$177,300	2010	strm.a600.601	393100	kg/hr	0.60	1.0	411178	1.05	\$182,148	\$174,160	\$174,160	
P-610	Reverse Osmosis Feed Pump	ADI		?		1	INCLUDED												
P-611	Centrifuge Feed Pump	ADI		10.0		2	\$61,200	2010	strm.a600.601	393100	kg/hr	0.60	1.0	411178	1.05	\$62,873	\$60,116	\$60,116	
P-612	Centrate Pump	ADI		15.0		2	\$70,800	2010	strm.a600.601	393100	kg/hr	0.60	1.0	411178	1.05	\$72,736	\$69,546	\$69,546	
P-616	Treated Water Pump				CS	1	INCLUDED												
R-609	Membrane Bioreactor	ADI	Includes membrane CIP and Scour system			3	\$5,248,750	2010	strm.a600.601	393100	kg/hr	0.60	1.0	411178	1.05	\$5,392,274	\$5,155,780	\$5,155,780	
S-611	Reverse Osmosis System	ADI				1	\$2,210,979	2010	strm.a600.601	393100	kg/hr	0.60	1.0	411178	1.05	\$2,271,437	\$2,171,816	\$2,171,816	
S-611	Centrifuge					3	\$6,493,500	2010	strm.a600.601	393100	kg/hr	0.60	1.0	411178	1.05	\$6,671,062	\$6,378,482	\$6,378,482	
T-606	Anaerobic Basin	ADI	31 Million gallonwith cover		CONCRETE	4	\$27,000,000	2010	strm.a600.601	393100	kg/hr	0.60	1.0	411178	1.05	\$27,738,302	\$26,521,754	\$26,521,754	
T-608	Aeration Digester	ADI	25 ft H x 115 ft x 344 ft 2 ft floor/wall thkness		CONCRETE	3	\$2,700,000	2010	strm.a600.601	393100	kg/hr	0.60	1.0	411178	1.05	\$2,773,830	\$2,652,175	\$2,652,175	
T-609	Sludge Holding Tank	ADI				1	INCLUDED												
<b>Area 600 Totals</b>																<b>\$51,654,964</b>	<b>\$49,389,478</b>	<b>\$49,389,478</b>	
A-701	Denaturant In-line Mixer		4 inch		SS304	1	\$3,850	2009	strm.703	23154	kg/hr	0.50	1.0	22273	0.96	\$3,776	\$3,801	\$3,801	
A-720	CSL Storage Tank Agitator	Lotus		10 hp	SS304	1	\$21,200	2009	strm.735	1393	kg/hr	0.50	1.5	1323	0.95	\$20,660	\$20,798	\$31,198	
A-760	DAP Make-up Tank Agitator	Lotus		5.5 hp	SS304	1	\$9,800	2009	strm.755	163	kg/hr	0.50	1.5	142	0.87	\$9,152	\$9,214	\$13,820	
C-755	DAP Bulk Bag Unloader	Flexicon	Super sack unloader			1	\$30,000	2009	strm.755	163	kg/hr	0.60	1.7	142	0.87	\$27,636	\$27,822	\$47,297	
P-701	Ethanol Product Pump	Goulds	150 GPM, 112 FT TDH	5.0	CS	2	\$9,200	2009	strm.a500.515	22681	kg/hr	0.80	3.1	21808	0.96	\$8,916	\$8,975	\$27,824	
P-703	Sulfuric Acid Pump	Goulds	5 GPM, 150 FT TDH SIZE 2X1-10	0.5	SS316	1	\$7,493	2010	strm.710	1981	kg/hr	0.80	2.3	1981	1.00	\$7,492	\$7,163	\$16,475	
P-704	Firewater Pump	Goulds	2500 GPM, 150 FT TDH	125.0	CS	1	\$15,000	2009	strm.a700.713	8343	kg/hr	0.80	3.1	8021	0.96	\$14,536	\$14,633	\$45,362	
P-710	Gasoline Pump	Goulds	4 GPM, 60 FT	0.5	CS	1	\$3,000	2009	strm.a700.701	473	kg/hr	0.80	3.1	465	0.98	\$2,959	\$2,979	\$9,234	
P-720	CSL Pump	Goulds	8 GPM, 80 FT TDH	0.5	CS	1	\$3,000	2009	strm.735	1393	kg/hr	0.80	3.1	1323	0.95	\$2,879	\$2,898	\$8,984	
P-760	DAP Pump	Goulds	2 GPM, 100 FT TDH	0.5	CS	1	\$3,000	2009	strm.755	163	kg/hr	0.80	3.1	142	0.87	\$2,689	\$2,707	\$8,392	
T-701	Ethanol Product Storage Tank	Mueller	750,000 gal., 7 day storage, Floating roof		A285C	2	\$1,340,000	2009	strm.a500.515	22681	kg/hr	0.70	1.7	21808	0.96	\$1,303,683	\$1,312,426	\$2,231,125	
T-703	Sulfuric Acid Storage Tank		12,600 gal, 12' dia x15' H		SS	1	\$96,000	2010	strm.710	1981	kg/hr	0.70	1.5	1981	1.00	\$95,987	\$91,777	\$137,666	
T-704	Firewater Storage Tank		600,000 gal - 4 hrs @ 2500 gpm		Glass lined	1	\$803,000	2009	strm.a700.713	8343	kg/hr	0.70	1.7	8021	0.96	\$781,201	\$786,440	\$1,336,948	
T-706	Ammonia Storage Tank	Chemithon	28,000 gal		SA- 516-70	2	\$196,000	2010	strm.717	1171	kg/hr	0.70	2.0	1166	1.00	\$195,389	\$186,820	\$373,639	
T-710	Gasoline Storage Tank		65,000 gal., floating roof		CS	1	\$200,000	2009	strm.a700.701	473	kg/hr	0.70	1.7	465	0.98	\$197,602	\$198,927	\$338,176	
T-720	CSL Storage Tank		70,000 gal		Glass lined CS	1	\$70,000	2009	strm.735	1393	kg/hr	0.70	2.6	1323	0.95	\$67,516	\$67,969	\$176,720	
T-755	DAP Bulk Bag Holder	Flexicon	Super sack holder			1	INCLUDED												
T-760	DAP Make-up Tank		12,800 gal		SS304	1	\$102,000	2009	strm.717	1615	kg/hr	0.70	1.8	1166	0.72	\$81,192	\$81,737	\$147,126	
<b>Area 700 Totals</b>																<b>\$2,823,265</b>	<b>\$2,827,086</b>	<b>\$4,953,786</b>	

Mechanical Equipment List								Scaled Installed Costs										
EQPT NO	EQUIPMENT TITLE	VENDOR	DESCRIPTION	HP	MATERIAL	NUM REQD	\$	Year of Quote	Scaling Variable	Scaling Val	Units	Scaling Exp	Inst Factor	New Val	Size Ratio	Scaled Purch Cost	Purch Cost in Proj year	Inst Cost in Proj year
H- 801	Bumer Combustion Air Preheater	Babcock & Wilcox				1	INCLUDED											
H- 811	BFW Preheater	Babcock & Wilcox				1	INCLUDED											
H- 812	Pretreatment/BFW heat recovery	Mueller	9.4 MM Btu/hr		SS304	1	\$41,000	2009	heat.QH812	-2	Gcal/hr	0.70	2.2	-2	0.93	\$38,856	\$39,117	\$86,057
M-802	Air Intake Fan	Babcock & Wilcox					INCLUDED											
M-803	Boiler	Babcock & Wilcox	525,000 lb/hr @ 900 psig	2752 kW	CS	1	\$28,550,000	2010	strm.a800.a810.812	238686	kg/hr	0.60	1.8	234784	0.98	\$28,269,041	\$27,029,216	\$48,652,589
M-804	Combustion Gas Baghouse	Babcock & Wilcox	INCLUDED WITH FGD SYSTEM				INCLUDED											
M-811	Turbine/Generator	Siemens	23.6 kW, 2 extractions			1	\$9,500,000	2010	work.wtotal	-42200	kW	0.60	1.8	-41324	0.98	\$9,381,215	\$8,969,773	\$16,145,591
M-820	Hot Process Water Softener System	Proctor Sales				1	\$78,000	2010	strm.a800.a810.812	235803	kg/hr	0.60	1.8	234784	1.00	\$77,798	\$74,386	\$133,894
M-830	Amine Addition Pkg.	Proctor Sales				1	\$40,000	2010	strm.a800.a810.812	235803	kg/hr	0.00	1.8	234784	1.00	\$40,000	\$38,246	\$68,842
M-832	Ammonia Addition Pkg	Proctor Sales				1	INCLUDED											
M-834	Phosphate Addition Pkg.	Proctor Sales				1	INCLUDED											
P- 804	Condensate Pump	Proctor Sales			SS316	2	INCLUDED											
P- 811	Turbine Condensate Pump	Proctor Sales			SS304	2	INCLUDED											
P- 824	Deaerator Feed Pump	Proctor Sales			SS304	2	INCLUDED											
P- 826	BFW Pump	Proctor Sales			SS316	5	INCLUDED											
P- 828	Blowdown Pump	Proctor Sales			CS	2	INCLUDED											
P- 830	Amine Transfer Pump	Proctor Sales			CS	1	INCLUDED											
T- 804	Condensate Collection Tank	Proctor Sales			A285C	1	INCLUDED											
T- 824	Condensate Surge Drum	Proctor Sales			SS304	1	INCLUDED											
T- 826	Deaerator	Proctor Sales	Tray type		CS,SS316	1	\$305,000	2010	strm.a800.a810.812	235803	kg/hr	0.60	3.0	234784	1.00	\$304,209	\$290,867	\$872,600
T- 828	Blowdown Flash Drum	Proctor Sales			CS	1	INCLUDED											
T- 830	Amine Drum	Proctor Sales			SS316	1	INCLUDED											
<b>Area 800 Totals</b>																\$38,111,118	\$36,441,604	\$65,959,573
M-902	Cooling Tower System	Marley SPX	44,200 gpm	750 hp	FIBERGLASS	1	\$1,375,000	2010	strm.a900.945	10037820	kg/hr	0.60	1.5	11923904	1.19	\$1,524,650	\$1,457,782	\$2,186,673
M-904	Plant Air Compressor	Rogers Machinery	400 SCFM@125 psig	150 hp		1	\$28,000	2010	DRY101	83333	kg/hr	0.60	1.6	83333	1.00	\$28,000	\$26,772	\$42,835
M-908	Chilled Water Package	Trane	2 x 2350 tons (14.2 MM kcal/hr)	3400 hp		1	\$1,275,750	2010	heat.a900.qchwop	14	Gcal/hr	0.60	1.6	13	0.95	\$1,234,354	\$1,180,217	\$1,888,348
M-910	CIP System		100,000 GAL		SS304/SS316	1	\$421,000	2009	strm.a900.914	63	kg/hr	0.60	1.8	145	2.30	\$694,222	\$698,878	\$1,257,980
P- 902	Cooling Water Pump	Goulds	16,120 GPM, 100 FT TDH SIZE 20X20-28	500.0	CS	3	\$283,671	2010	strm.a900.945	10982556	kg/hr	0.80	3.1	11923904	1.09	\$302,961	\$289,674	\$897,989
P- 912	Make-up Water Pump	Goulds	685 GPM, 75 FT TDH SIZE 6X4-13	20.0	CS	1	\$6,864	2010	strm.a900.904	155564	kg/hr	0.80	3.1	147140	0.95	\$6,565	\$6,277	\$19,459
P- 914	Process Water Circulating Pump	Goulds	2285 GPM, 75 FT TDH SIZE 8X6-13	75.0	CS	1	\$15,292	2010	strm.a900.905	518924	kg/hr	0.80	3.1	523463	1.01	\$15,399	\$14,724	\$45,643
S- 904	Instrument Air Dryer	Zeks	670 SCFM - CYCLING TYPE		CS	1	\$15,000	2009	DRY101	83333	kg/hr	0.60	1.8	83333	1.00	\$15,000	\$15,101	\$27,181
T- 904	Plant Air Receiver	Rogers Machinery	3800 gal - 72" x 228" vertical		CS	1	\$16,000	2009	DRY101	83333	kg/hr	0.60	3.1	83333	1.00	\$16,000	\$16,107	\$49,933
T- 914	Process Water Tank No. 1		250,000 gal		CS	1	\$250,000	2009	strm.a900.905	451555	kg/hr	0.70	1.7	523463	1.16	\$277,245	\$279,104	\$474,476
<b>Area 900 Totals</b>																\$4,114,396	\$3,984,635	\$6,890,517
<b>Grand Totals</b>																\$158,381,833	\$154,486,458	\$232,035,959



**Appendix B. Discounted Cash Flow Rate of Return Worksheet**

Year	-2	-1	0	1	2	3	4	5	6	
Fixed Capital Investment										
Land	\$12,819,631	\$96,147,231	\$51,278,523							
Working Capital			\$20,030,673							
Loan Payment				\$35,821,932	\$35,821,932	\$35,821,932	\$35,821,932	\$35,821,932	\$35,821,932	
Loan Interest Payment	\$1,538,356	\$13,076,023	\$19,229,446	\$19,229,446	\$17,902,047	\$16,468,457	\$14,920,179	\$13,248,038	\$11,442,127	
Loan Principal	\$19,229,446	\$163,450,293	\$240,368,078	\$223,775,593	\$205,855,708	\$186,502,233	\$165,600,480	\$143,026,587	\$118,646,782	
Ethanol Sales				\$114,997,260	\$131,425,440	\$131,425,440	\$131,425,440	\$131,425,440	\$131,425,440	
By-Product Credit				\$5,745,024	\$6,565,742	\$6,565,742	\$6,565,742	\$6,565,742	\$6,565,742	
Total Annual Sales				\$120,742,284	\$137,991,181	\$137,991,181	\$137,991,181	\$137,991,181	\$137,991,181	
Annual Manufacturing Cost										
Feedstock				\$39,550,982	\$45,201,122	\$45,201,122	\$45,201,122	\$45,201,122	\$45,201,122	
Baghouse Bags				\$466,183					\$466,183	
Other Variable Costs				\$25,025,596	\$26,693,969	\$26,693,969	\$26,693,969	\$26,693,969	\$26,693,969	
Fixed Operating Costs				\$10,655,826	\$10,655,826	\$10,655,826	\$10,655,826	\$10,655,826	\$10,655,826	
Total Product Cost				\$75,698,586	\$82,550,916	\$82,550,916	\$82,550,916	\$82,550,916	\$83,017,099	
Annual Depreciation										
General Plant Writedown				14%	24.49%	17.49%	12.49%	8.93%	8.92%	
Depreciation Charge				\$47,822,041	\$81,956,738	\$58,530,965	\$41,798,271	\$29,884,592	\$29,851,127	
Remaining Value				\$286,831,849	\$204,875,112	\$146,344,146	\$104,545,875	\$74,661,283	\$44,810,156	
Steam Plant Writedown				3.75%	7.22%	6.68%	6.18%	5.71%	5.29%	
Depreciation Charge				\$2,473,484	\$4,761,622	\$4,404,121	\$4,074,323	\$3,768,270	\$3,485,963	
Remaining Value				\$63,486,089	\$58,724,468	\$54,320,347	\$50,246,024	\$46,477,754	\$42,991,790	
Net Revenue					(\$24,481,274)	(\$49,180,142)	(\$23,963,278)	(\$5,352,508)	\$8,539,364	\$10,194,864
Losses Forward						(\$24,481,274)	(\$73,661,416)	(\$97,624,694)	(\$102,977,201)	(\$94,437,838)
Taxable Income					(\$24,481,274)	(\$73,661,416)	(\$97,624,694)	(\$102,977,201)	(\$94,437,838)	(\$84,242,973)
Income Tax					\$0	\$0	\$0	\$0	\$0	\$0
Annual Cash Income					\$9,221,766	\$19,618,333	\$19,618,333	\$19,618,333	\$19,618,333	\$19,152,150
Discount Factor	1.2100	1.1000	1.0000	0.9091	0.8264	0.7513	0.6830	0.6209	0.5645	
Annual Present Value	\$227,041,341			\$8,383,423	\$16,213,498	\$14,739,544	\$13,399,585	\$12,181,441	\$10,810,889	
Total Capital Investment + Interest		\$19,609,244	\$120,145,580	\$90,538,643						
Net Present Worth				\$0						
Year	7	8	9	10	11	12	13	14	15	16
Fixed Capital Investment										
Land										
Working Capital										
Loan Payment	\$35,821,932	\$35,821,932	\$35,821,932	\$35,821,932	\$0	\$0	\$0	\$0	\$0	\$0
Loan Interest Payment	\$9,491,743	\$7,385,327	\$5,110,399	\$2,653,476	\$0	\$0	\$0	\$0	\$0	\$0
Loan Principal	\$92,316,592	\$63,879,988	\$33,168,455	\$0	\$0	\$0	\$0	\$0	\$0	\$0
Ethanol Sales	\$131,425,440	\$131,425,440	\$131,425,440	\$131,425,440	\$131,425,440	\$131,425,440	\$131,425,440	\$131,425,440	\$131,425,440	\$131,425,440
By-Product Credit	\$6,565,742	\$6,565,742	\$6,565,742	\$6,565,742	\$6,565,742	\$6,565,742	\$6,565,742	\$6,565,742	\$6,565,742	\$6,565,742
Total Annual Sales	\$137,991,181	\$137,991,181	\$137,991,181	\$137,991,181	\$137,991,181	\$137,991,181	\$137,991,181	\$137,991,181	\$137,991,181	\$137,991,181
Annual Manufacturing Cost										
Feedstock	\$45,201,122	\$45,201,122	\$45,201,122	\$45,201,122	\$45,201,122	\$45,201,122	\$45,201,122	\$45,201,122	\$45,201,122	\$45,201,122
Baghouse Bags					\$466,183					\$466,183
Other Variable Costs	\$26,693,969	\$26,693,969	\$26,693,969	\$26,693,969	\$26,693,969	\$26,693,969	\$26,693,969	\$26,693,969	\$26,693,969	\$26,693,969
Fixed Operating Costs	\$10,655,826	\$10,655,826	\$10,655,826	\$10,655,826	\$10,655,826	\$10,655,826	\$10,655,826	\$10,655,826	\$10,655,826	\$10,655,826
Total Product Cost	\$82,550,916	\$82,550,916	\$82,550,916	\$82,550,916	\$83,017,099	\$82,550,916	\$82,550,916	\$82,550,916	\$82,550,916	\$83,017,099
Annual Depreciation										
General Plant Writedown	8.93%	4.46%								
Depreciation Charge	\$29,884,592	\$14,925,564								
Remaining Value	\$14,925,564	\$0								
Steam Plant Writedown	4.89%	4.52%	4.46%	4.46%	4.46%	4.46%	4.46%	4.46%	4.46%	4.46%
Depreciation Charge	\$3,224,104	\$2,982,692	\$2,943,116	\$2,942,457	\$2,943,116	\$2,942,457	\$2,943,116	\$2,942,457	\$2,943,116	\$2,942,457
Remaining Value	\$39,767,686	\$36,784,995	\$33,841,878	\$30,899,422	\$27,956,306	\$25,013,849	\$22,070,733	\$19,128,276	\$16,185,160	\$13,242,704
Net Revenue	\$12,839,826	\$30,146,682	\$47,386,750	\$49,844,332	\$52,030,966	\$52,497,808	\$52,497,149	\$52,497,808	\$52,497,149	\$52,031,625
Losses Forward	(\$84,242,973)	(\$71,403,147)	(\$41,256,465)	\$0	\$0	\$0	\$0	\$0	\$0	\$0
Taxable Income	(\$71,403,147)	(\$41,256,465)	\$6,130,284	\$49,844,332	\$52,030,966	\$52,497,808	\$52,497,149	\$52,497,808	\$52,497,149	\$52,031,625
Income Tax	\$0	\$0	\$2,145,599	\$17,445,516	\$18,210,838	\$18,374,233	\$18,374,002	\$18,374,233	\$18,374,002	\$18,211,069
Annual Cash Income	\$19,618,333	\$19,618,333	\$17,472,734	\$2,172,817	\$36,763,244	\$37,066,032	\$37,066,032	\$37,066,032	\$37,066,263	\$36,763,013
Discount Factor	0.5132	0.4665	0.4241	0.3855	0.3505	0.3186	0.2897	0.2633	0.2394	0.2176
Annual Present Value	\$10,067,307	\$9,152,097	\$7,410,145	\$837,715	\$12,885,293	\$11,810,380	\$10,736,776	\$9,760,645	\$8,873,369	\$8,000,703
Total Capital Investment + Interest										
Net Present Worth										

Year	17	18	19	20	21	22	23	24	25	26
Fixed Capital Investment										
Land										
Working Capital										
Loan Payment	\$0	\$0	\$0	\$0	\$0	\$0	\$0	\$0	\$0	\$0
Loan Interest Payment	\$0	\$0	\$0	\$0	\$0	\$0	\$0	\$0	\$0	\$0
Loan Principal	\$0	\$0	\$0	\$0	\$0	\$0	\$0	\$0	\$0	\$0
Ethanol Sales	\$131,425,440	\$131,425,440	\$131,425,440	\$131,425,440	\$131,425,440	\$131,425,440	\$131,425,440	\$131,425,440	\$131,425,440	\$131,425,440
By-Product Credit	\$6,565,742	\$6,565,742	\$6,565,742	\$6,565,742	\$6,565,742	\$6,565,742	\$6,565,742	\$6,565,742	\$6,565,742	\$6,565,742
Total Annual Sales	\$137,991,181	\$137,991,181	\$137,991,181	\$137,991,181	\$137,991,181	\$137,991,181	\$137,991,181	\$137,991,181	\$137,991,181	\$137,991,181
Annual Manufacturing Cost										
Feedstock	\$45,201,122	\$45,201,122	\$45,201,122	\$45,201,122	\$45,201,122	\$45,201,122	\$45,201,122	\$45,201,122	\$45,201,122	\$45,201,122
Baghouse Bags						\$466,183				\$466,183
Other Variable Costs	\$26,693,969	\$26,693,969	\$26,693,969	\$26,693,969	\$26,693,969	\$26,693,969	\$26,693,969	\$26,693,969	\$26,693,969	\$26,693,969
Fixed Operating Costs	\$10,655,826	\$10,655,826	\$10,655,826	\$10,655,826	\$10,655,826	\$10,655,826	\$10,655,826	\$10,655,826	\$10,655,826	\$10,655,826
Total Product Cost	\$82,550,916	\$82,550,916	\$82,550,916	\$82,550,916	\$83,017,099	\$82,550,916	\$82,550,916	\$82,550,916	\$82,550,916	\$83,017,099
Annual Depreciation										
General Plant Writedown										
Depreciation Charge										
Remaining Value										
Steam Plant Writedown	4.46%	4.46%	4.46%	4.46%	2.23%					
Depreciation Charge	\$2,943,116	\$2,942,457	\$2,943,116	\$2,942,457	\$1,471,558					
Remaining Value	\$10,299,587	\$7,357,131	\$4,414,015	\$1,471,558	\$0					
Net Revenue	\$52,497,149	\$52,497,808	\$52,497,149	\$52,497,808	\$53,502,524	\$55,440,265	\$55,440,265	\$55,440,265	\$55,440,265	\$54,974,082
Losses Forward	\$0	\$0	\$0	\$0	\$0	\$0	\$0	\$0	\$0	\$0
Taxable Income	\$52,497,149	\$52,497,808	\$52,497,149	\$52,497,808	\$53,502,524	\$55,440,265	\$55,440,265	\$55,440,265	\$55,440,265	\$54,974,082
Income Tax	\$18,374,002	\$18,374,233	\$18,374,002	\$18,374,233	\$18,725,883	\$19,404,093	\$19,404,093	\$19,404,093	\$19,404,093	\$19,240,929
Annual Cash Income	\$37,066,263	\$37,066,032	\$37,066,263	\$37,066,032	\$36,248,199	\$36,036,172	\$36,036,172	\$36,036,172	\$36,036,172	\$35,733,153
Discount Factor	0.1978	0.1799	0.1635	0.1486	0.1351	0.1228	0.1117	0.1015	0.0923	0.0839
Annual Present Value	\$7,333,362	\$6,666,652	\$6,060,630	\$5,509,629	\$4,898,240	\$4,426,899	\$4,024,453	\$3,658,594	\$3,325,994	\$2,998,206
Total Capital Investment + Interest										
Net Present Worth										
Year	27	28	29	30						
Fixed Capital Investment										
Land										
Working Capital										
Loan Payment	\$0	\$0	\$0	\$0						
Loan Interest Payment	\$0	\$0	\$0	\$0						
Loan Principal	\$0	\$0	\$0	\$0						
Ethanol Sales	\$131,425,440	\$131,425,440	\$131,425,440	\$131,425,440						
By-Product Credit	\$6,565,742	\$6,565,742	\$6,565,742	\$6,565,742						
Total Annual Sales	\$137,991,181	\$137,991,181	\$137,991,181	\$137,991,181						
Annual Manufacturing Cost										
Feedstock	\$45,201,122	\$45,201,122	\$45,201,122	\$45,201,122						
Baghouse Bags										
Other Variable Costs	\$26,693,969	\$26,693,969	\$26,693,969	\$26,693,969						
Fixed Operating Costs	\$10,655,826	\$10,655,826	\$10,655,826	\$10,655,826						
Total Product Cost	\$82,550,916	\$82,550,916	\$82,550,916	\$82,550,916						
Annual Depreciation										
General Plant Writedown										
Depreciation Charge										
Remaining Value										
Steam Plant Writedown										
Depreciation Charge										
Remaining Value										
Net Revenue	\$55,440,265	\$55,440,265	\$55,440,265	\$55,440,265						
Losses Forward	\$0	\$0	\$0	\$0						
Taxable Income	\$55,440,265	\$55,440,265	\$55,440,265	\$55,440,265						
Income Tax	\$19,404,093	\$19,404,093	\$19,404,093	\$19,404,093						
Annual Cash Income	\$36,036,172	\$36,036,172	\$36,036,172	\$36,036,172						
Discount Factor	0.0763	0.0693	0.0630	0.1486						
Annual Present Value	\$2,748,756	\$2,498,869	\$2,271,699							
Total Capital Investment + Interest										
Net Present Worth										

## Appendix C. Process Parameters/Operating Summary

<b>Feedstock</b>		<b>Conditioning</b>		<b>Boiler/Turbogenerator</b>	
Moisture Content	20%	Ammonia Loading (% stoich. XS)	0.0%	WWT sludge moisture %	79.0%
<b>Pretreatment</b>		Ammonia Loading (g/L hydrolyzate)	4.7	First effect lignin moisture %	35.0%
Acid Conc (wt%)	0.82	<b>Sugar Losses:</b>		Combined boiler feed moisture	44.3%
Acid Loading (mg/g dry biomass)	22.1	Xylose	1.0%	Boiler feed combustion energy MMkcal/hr	-181
Total Solids (wt%)	30.0%	Arabinose	1.0%	% from lignin cake	54%
Insoluble Solids in (wt%)	22.6%	Glucose	0.0%	% from biogas	36%
Insoluble Solids out (wt%)	16.6%	Galactose	1.0%	Boiler feed heating value (kcal/kg)	-497
Temperature (°C)	158	Mannose	1.0%	Boiler feed heating value (Btu/lb)	-895
Pressure (atm)	5.7	Cellobiose	1.0%		
<b>Conversions</b>		<b>Fermentation</b>		Boiler efficiency (feed/steam)	80%
Cellulose to Glucolig	0.3%	Total Solids (wt%)	19.8%		
Cellulose to Cellobiose	0.0%	Insoluble Solids (wt%)	5.1%	Steam loop flow (kg/hr)	234,784
Cellulose to Glucose	9.9%	Temperature (°C)	32	Total Generator Output (kW)	-41,324
Cellulose to HMF	0.3%	Pressure (atm)	1.0	to A100 Feedstock Handling	859
Xylan to Oligomer	2.4%	Residence Time (days)	1.5	to A200 Pretreatment	5,680
Xylan to Xylose	90.0%	<b>Conversions:</b>		to A300 Hydrolysis & Fermentation	2,636
Xylan to Furfural	5.0%	Glucose to Ethanol	95.0%	to A400 Enzyme Production	5,340
Xylan to Tar	0.0%	Glucose to Zymo (cell mass)	2.0%	to A500 Recovery	2,124
Mannan to Oligomer	2.4%	Glucose to Glycerol	0.4%	to A600 Wastewater	7,368
Mannan to Mannose	90.0%	Glucose to Succinic Acid	0.6%	to A700 Storage	11
Mannan to HMF	5.0%	Glucose to Acetic Acid	0.0%	to A800 Boiler/Turbogen	1,368
Galactan to Oligomer	2.4%	Glucose to Lactic Acid	0.0%	to A900 Utilities	3,141
Galactan to Galactose	90.0%	Xylose to Ethanol	85.0%	Excess electricity to grid	12,797
Galactan to HMF	5.0%	Xylose to Zymo	1.9%	Electricity Used (kW)	28,527
Arabinan to Oligomer	2.4%	Xylose to Glycerol	0.3%	Electricity Used (%)	69%
Arabinan to Arabinose	90.0%	Xylose to Xylitol	4.6%	<b>Wastewater Treatment</b>	
Arabinan to Furfural	5.0%	Xylose to Succinic Acid	0.9%	NH3-N to Ferm mg/L	1,608
Arabinan to Tar	0.0%	Xylose to Acetic Acid	0.0%	NH3-N out of Ferm mg/L	1,565
Acetate to Oligomer	0.0%	Xylose to Lactic Acid	0.0%	Protein-N	0
Acetate to Acetic Acid	100.0%	Arabinose to Ethanol	85.0%	Cellulase-N	202
Furfural to Tar	100.0%	Arabinose to Zymo	1.9%	NH3-N in Combined WW mg/L	667
HMF to Tar	100.0%	Arabinose to Glycerol	0.3%	Protein-N	0
Lignin to Soluble Lignin	5.0%	Arabinose to Succinic Acid	1.5%	Cellulase-N	43
Xylose olig to xylose		Arabinose to Acetic Acid	0.0%	Hydraulic Load (L/hr)	416,673
Mannose olig to mannose		Arabinose to Lactic Acid	0.0%	Hydraulic Load (gpm)	1,835
Arabinose olig to arabinose		Galactose to Ethanol	0.0%	Hydraulic Load (MMgal/day)	2.6
Galactose olig to galactose		Galactose to Zymo	0.0%	Total COD (kg/hr)	26,536
<b>Enzymatic Hydrolysis</b>		Galactose to Glycerol	0.0%	Total COD (g/L)	63.7
Enzyme Loading (mg/g cell)	19.9	Galactose to Succinic Acid	0.0%		
Total Solids (wt%)	20.0%	Galactose to Acetic Acid	0.0%	Biogas composition (Dry molar%)	CH4 51%
Insoluble Solids (wt%)	10.6%	Galactose to Lactic Acid	0.0%		CO2 49%
Temperature (°C)	32	Galactose to Ethanol	0.0%	methane produced (kg/kg COD)	0.223
Pressure (atm)	1.0	Mannose to Zymo	0.0%	cell mass	0.044
Residence Time (days)	3.5	Mannose to Glycerol	0.0%		
<b>Conversions:</b>		Mannose to Succinic Acid	0.0%		
Cellulose to Glucolig	4.0%	Mannose to Acetic Acid	0.0%		
Cellulose to Cellobiose	1.2%	Mannose to Lactic Acid	0.0%		
Cellulose to Glucose	90.0%				
Glucolig to Cellobiose	0.0%	Corn Steep Liquor loading wt%	0.00%		
Glucolig to Glucose	0.0%	Contamination Loss	3.0%		
Cellobiose to Glucose	0.0%	Ethanol Out of Fermenters (wt%)	5.4%		
Xylan to Oligomer	0.0%	<b>Enzyme Production</b>			
Xylan to Xylose	0.0%	Glucose feed (kg/hr)	2,418		
Xylose Oligomer to Xylose	0.0%	Protein produced (kg/hr)	579		
Xylan to Tar	0.0%	Protein yield (kg/kg substrate)	0.24		
Arabinan to Oligomer	0.0%	Protein harvest titer (g/L)	40		
Arabinan to Arabinose	0.0%				
Galactan to Oligomer	0.0%	Compressor electricity (kW)	1408		
Galactan to Galactose	0.0%	Agitator electricity (kW)	2093		
Galactose Oligomer to Galactose	0.0%	Chiller system electricity (kW)	1587		
Mannan to Oligomer	0.0%	A400 total electricity (kW)	5340		
Mannan to Mannose	0.0%				
Mannose Oligomer to Mannose	0.0%	Electricity demand (kWh/kg protn)	9		
		Production selectivity:			
		Selectivity to protein	31.3%		
		Selectivity to cell mass	4.1%		
		Selectivity to CO2	67.6%		

## **Appendix D. Aspen Properties**

The first table in this appendix is a list of the components used in the Aspen model. Previous versions of the model used custom property databanks created at NREL. Where possible in the new model, these components have been replaced with components from Aspen's native databanks. Property definitions for the few remaining custom components were moved into the model itself (i.e., inside the simulation file) and are discussed here.

The second table is a list of combustion energies (LHV and HHV) computed using heats of formation from Aspen.

The component CSL (corn steep liquor) used in previous models was removed. CSL streams are now modeled as 50% water, 25% protein, and 25% lactic acid [89].

Component	Property	Quantity	Units	Reference
H2O	-	-	-	Native Aspen component
ETHANOL	-	-	-	Native Aspen component
GLUCOSE	-	-	-	Native Aspen component (dextrose)
GALACTOS	-	-	-	Duplicate of GLUCOSE
MANNOSE	-	-	-	Duplicate of GLUCOSE
XYLOSE	DHFORM	-216752.65	cal/mol	Native Aspen component (d-xylose) with DHFORM specified (5/6 of GLUCOSE DHFORM)
ARABINOS	-	-	-	Duplicate of XYLOSE
CELLOB	-	-	-	Cellobiose. Used native Aspen component sucrose
SUCROSE	-	-	-	Native Aspen component
GLUCOLIG	MW	162.1424		Glucose oligomers. Most properties from GLUCOSE; MW is GLUCOSE minus H2O
	DHFORM	-192875.34	cal/mol	Back-calculated to match $\Delta H_c$ of CELLULOS
GALAOLIG	-	-	-	Galactose oligomers. Duplicate of GLUCOLIG
MANOLIG	-	-	-	Mannose oligomers. Duplicate of GLUCOLIG
XYLOLIG	MW	132.11612		Xylose oligomers. Most properties from XYLOSE; MW is XYLOSE minus H2O
	DHFORM	-149412.58	cal/mol	Back-calculated to match $\Delta H_c$ of XYLAN
ARABOLIG	-	-	-	Arabinose oligomers. Duplicate of XYLOLIG
EXTRACT	-	-	-	Organic extractives. Duplicate of GLUCOSE
LGNSOL	-	-	-	Solubilized lignin. Native Aspen component vanillin (see note at LIGNIN)

Component	Property	Quantity	Units	Reference
HMF	MW	126.11		(5-hydroxymethylfurfural) Properties for HMF were estimated within Aspen using NIST TDE routines. Specify molecular structure, MW, TB and DHFORM. From [90].
	TB	532.7	K	
	DHFORM	-79774.53	cal/mol	
	DHVLWT-1	80550000	J/kmol	
	TC	731.012	K	NIST TDE
	PC	5235810	Pa	
	OMEGA	0.993646710		
	VC	0.3425	m <sup>3</sup> /kmol	
	RKTZRA	0.198177974		
FURFURAL	-	-	-	Native Aspen component
AACID	-	-	-	Native Aspen component (acetic acid)
LACID	-	-	-	Native Aspen component (lactic acid)
XYLITOL	-	-	-	Native Aspen component
GLYCEROL	-	-	-	Native Aspen component
SUCCACID	-	-	-	Native Aspen component (Succinic acid)
NH3	-	-	-	Native Aspen component
H2SO4	-	-	-	Native Aspen component
NH4SO4	-	-	-	Native Aspen component (ammonium sulfate)
NH4ACET	PLXANT/1	-1E20	atm	Native Aspen component (ammonium acetate) forced non-volatile
DAP	-	-	-	Native Aspen component (diammonium phosphate)
HNO3	-	-	-	Native Aspen component
NANO3	-	-	-	Native Aspen component
NAOH	-	-	-	Native Aspen component
CNUTR	-	-	-	Cellulase nutrient mix. Duplicate of glucose
WNUTR	-	-	-	WWT nutrient mix. Duplicate of glucose
DENAT	-	-	-	Denaturant. Native Aspen component (n-heptane)
OIL	-	-	-	Corn oil antifoam. Native Aspen component (oleic acid)
O2	-	-	-	Native Aspen component

Component	Property	Quantity	Units	Reference
N2	-	-	-	Native Aspen component
NO	-	-	-	Native Aspen component
NO2	-	-	-	Native Aspen component
CO	-	-	-	Native Aspen component
CO2	-	-	-	Native Aspen component
CH4	-	-	-	Native Aspen component
H2S	-	-	-	Native Aspen component
SO2	-	-	-	Native Aspen component
CELLULOS	DHSFRM	-233200.06	cal/mol	Native Aspen component with specified heat of formation; back-calculated
GALACTAN	-	-	-	Duplicate of CELLULOS
MANNAN	-	-	-	Duplicate of CELLULOS
XYLAN	Formula	C <sub>5</sub> H <sub>8</sub> O <sub>4</sub> (monomer)		
	MW	132.117		
	DHSFRM	-182099.93	cal/mol	From [22]. Assumes the ratio of $\Delta H_c$ of glucose:xylose is the same for cellulose:xylan.
ARABINAN	-	-	-	Duplicate of xylan
LIGNIN	-	-	-	Used native Aspen component vanillin (C <sub>8</sub> H <sub>8</sub> O <sub>3</sub> ). The HHV of this compound (-23,906 BTU/kg) is very close to what we previously assumed for lignin as a custom component (-24,206)
ACETATE	-	-	-	Used native Aspen component acetic acid
PROTEIN	Formula	CH <sub>1.57</sub> O <sub>0.31</sub> N <sub>0.29</sub> S <sub>0.007</sub>		Wheat gliadin [91]
	MW	22.8396		
	DHSFRM	-17618	cal/mol	From literature value of gliadin $\Delta H_c$ [92]
	PLXANT/1	-1E20	atm	Forces non-volatility
ASH	-	-	-	Native Aspen component CaO
ENZYME	Formula	CH <sub>1.59</sub> O <sub>0.42</sub> N <sub>0.24</sub> S <sub>0.01</sub>		Provided by Novozymes [55]
	MW	24.0156		
	DHSFRM	-17618	cal/mol	copied from PROTEIN
DENZ	-	-	-	Denatured enzyme. Duplicate of enzyme



Component	Property	Quantity	Units	Reference
ZYMO	Formula	CH <sub>1.8</sub> O <sub>0.5</sub> N <sub>0.2</sub>		Z. mobilis cell mass. Average composition of several microorganisms outlined in [93]
	MW	24.6264		
	DHSFRM	-31169.39	cal/mol	From [22] after [94]
TRICHO	Formula	CH <sub>1.645</sub> O <sub>0.445</sub> N <sub>0.205</sub> S <sub>0.005</sub>		T. reesei cell mass. Average of generic cell mass [56] and the ENZYME composition
	MW	23.8204		
	DHSFRM	-23200.01	cal/mol	Copied BIOMASS
BIOMASS	Formula	CH <sub>1.64</sub> O <sub>0.39</sub> N <sub>0.23</sub> S <sub>0.0035</sub>		WWT sludge.
	MW	23.238		
	DHSFRM	-23200.01	cal/mol	From [22] after [94]
TAR	-	-	-	Modeled as solid xylose
LIME	-	-	-	Aspen native component (calcium hydroxide)
CASO4	-	-	-	Aspen native component
C	-	-	-	Aspen native component (graphite carbon)

	MW ΔHf (IG) ΔHf (L) ΔHf (S)										LHV			HHV									
	cal/mol	cal/mol	cal/mol	cal/mol							cal/mol	Gcal/kmol	BTU/lb	cal/mol	Gcal/kmol	BTU/lb							
GLUCOSE	180.16	-260103	-300428		GLUCOSE	+	6 O2	→	6 H2O	+	6 CO2							-610039	-0.610039	-6095	-672895	-0.672895	-6723
XYLOSE	150.13	-216753	-249440		XYLOSE	+	5 O2	→	5 H2O	+	5 CO2							-509283	-0.509283	-6106	-561662	-0.561662	-6734
SUCROSE	342.30	-459301	-480900		SUCROSE	+	12 O2	→	11 H2O	+	12 CO2							-1282278	-1.282278	-6743	-1397513	-1.397513	-7349
EXTRACT	180.16	-260103	-300428		EXTRACT	+	6 O2	→	6 H2O	+	6 CO2							-610039	-0.610039	-6095	-672895	-0.672895	-6723
ARABINOS	150.13	-216753	-249440		ARABINOS	+	5 O2	→	5 H2O	+	5 CO2							-509283	-0.509283	-6106	-561662	-0.561662	-6734
GALACTOS	180.16	-260103	-300428		GALACTOS	+	6 O2	→	6 H2O	+	6 CO2							-610039	-0.610039	-6095	-672895	-0.672895	-6723
MANNOSE	180.16	-260103	-300428		MANNOSE	+	6 O2	→	6 H2O	+	6 CO2							-610039	-0.610039	-6095	-672895	-0.672895	-6723
GLUCOLIG	162.14	-192875	-233200		GLUCOLIG	+	6 O2	→	5 H2O	+	6 CO2							-619511	-0.619511	-6877	-671890	-0.671890	-7459
CELLOB	342.30	-459301	-480900		CELLOB	+	12 O2	→	11 H2O	+	12 CO2							-1282278	-1.282278	-6743	-1397513	-1.397513	-7349
XYLOLIG	132.12	-149413	-182100		XYLOLIG	+	5 O2	→	4 H2O	+	5 CO2							-518866	-0.518866	-7069	-560770	-0.560770	-7640
MANOLIG	162.14	-192875	-233200		MANOLIG	+	6 O2	→	5 H2O	+	6 CO2							-619511	-0.619511	-6877	-671890	-0.671890	-7459
GALAOLIG	162.14	-192875	-233200		GALAOLIG	+	6 O2	→	5 H2O	+	6 CO2							-619511	-0.619511	-6877	-671890	-0.671890	-7459
ARABOLIG	132.12	-149413	-182100		ARABOLIG	+	5 O2	→	4 H2O	+	5 CO2							-518866	-0.518866	-7069	-560770	-0.560770	-7640
XYLITOL	152.15	-222246	-243145	-267149	XYLITOL	+	5.5 O2	→	6 H2O	+	5 CO2							-573334	-0.573334	-6783	-636190	-0.636190	-7527
LGNSOL	152.15	-88134	-108248		LGNSOL	+	8.5 O2	→	4 H2O	+	8 CO2							-874683	-0.874683	-10348	-916587	-0.916587	-10844
ETHANOL	46.07	-56117	-66278		ETHANOL	+	3 O2	→	3 H2O	+	2 CO2							-294968	-0.294968	-11525	-326395	-0.326395	-12753
H2O	18.02	-57756	-68232	-69963	NA																		
FURFURAL	96.09	-36066	-47738		FURFURAL	+	5 O2	→	2 H2O	+	5 CO2							-537716	-0.537716	-10073	-558667	-0.558667	-10466
HMF	126.11	-79775	-99677		HMF	+	6 O2	→	3 H2O	+	6 CO2							-637521	-0.637521	-9099	-668949	-0.668949	-9548
H2SO4	98.08	-175600	-189490		H2SO4	+	-0.5 O2	→	1 H2O									60835	0.060835	1116	50359	0.050359	924
N2	28.01	0	--	--	NA																		
CO2	44.01	-93988	-95245		NA																		
O2	32.00	0	--	--	NA																		
CH4	16.04	-17799	--	--	CH4	+	2 O2	→	2 H2O	+	1 CO2							-191702	-0.191702	-21509	-212654	-0.212654	-23860
NO	30.01	21556	--	--	NO	+	0.5 O2	→										-13631	-0.013631	-818	-13631	-0.013631	-818
NO2	46.01	7925	-1179		NA																		
NH3	17.03	-10963	-15706		NH3	+	0.75 O2	→	1.5 H2O									-75672	-0.075672	-7998	-91386	-0.091386	-9659
LACID	90.08	-143212	-163122		LACID	+	3 O2	→	3 H2O	+	3 CO2							-292112	-0.292112	-5837	-323539	-0.323539	-6465
AACID	60.05	-103373	-108966		AACID	+	2 O2	→	2 H2O	+	2 CO2							-194523	-0.194523	-5831	-215474	-0.215474	-6459
NH4SO4	132.14	-282029	-288994	-282041	NH4SO4	+	1 O2	→	4 H2O									-12930	-0.012930	-176	-54834	-0.054834	-747
NH4ACET	77.08	-147163	-154701	-147163	NH4ACET	+	2.75 O2	→	3.5 H2O	+	2 CO2	+	0.5 N2					-235422	-0.235422	-5498	-272088	-0.272088	-6354
GLYCEROL	92.09	-138029	-159483		GLYCEROL	+	3.5 O2	→	4 H2O	+	3 CO2							-353507	-0.353507	-6909	-395411	-0.395411	-7728
SUCCACID	118.09	-196546	-221160	-231172	SUCCACID	+	3.5 O2	→	3 H2O	+	4 CO2							-328062	-0.328062	-5001	-359490	-0.359490	-5480
DAP	132.06	-276457	-283996	-374250	NA																		
DENAT	100.20	-44819	-53568		DENAT	+	11 O2	→	8 H2O	+	7 CO2							-1066400	-1.066400	-19156	-1150207	-1.150207	-20662
OIL	282.47	-169628	-196067		OIL	+	25.5 O2	→	17 H2O	+	18 CO2							-2477579	-2.477579	-15788	-2655669	-2.655669	-16923
CNUTR	180.16	-260103	-300428		CNUTR	+	6 O2	→	6 H2O	+	6 CO2							-610039	-0.610039	-6095	-672895	-0.672895	-6723
WNUTR	180.16	-260103	-300428		WNUTR	+	6 O2	→	6 H2O	+	6 CO2							-610039	-0.610039	-6095	-672895	-0.672895	-6723

	MW $\Delta H_f$ (IG) $\Delta H_f$ (L) $\Delta H_f$ (S)						LHV			HHV									
	cal/mol	cal/mol	cal/mol				cal/mol	Gcal/kmol	BTU/lb	cal/mol	Gcal/kmol	BTU/lb							
SO2	64.06	-70899	-76380	NA															
H2S	34.08	-4927	-8300	H2S	+	1.5 O2 →	1 H2O			+	1 SO2	-123728	-0.123728	-6535	-134204	-0.134204	-7088		
CO	28.01	-26400	--	CO	+	0.5 O2 →		1 CO2				-67589	-0.067589	-4343	-67589	-0.067589	-4343		
HNO3	63.01	-32077	-41406	HNO3	+	-1.75 O2 →	0.5 H2O			+	0.5 N2	12528	0.012528	358	-2039	-0.002039	-58		
NA2O			-6965	NA															
NAOH	40.00	-47234	-67046	NAOH	+	0 O2 →	0.5 H2O					34685	0.034685	1561	9636	0.009636	434		
NANO3	84.99		-118756	NANO3	+	-1.25 O2 →				0.5 N2		115273	0.115273	2441	115273	0.115273	2441		
CELLULOS	162.14		-233200	CELLULOS	+	6 O2 →	5 H2O	+	6 CO2			-619511	-0.619511	-6877	-671890	-0.671890	-7459		
XYLAN	132.12		-182100	XYLAN	+	5 O2 →	4 H2O	+	5 CO2			-518866	-0.518866	-7069	-560770	-0.560770	-7640		
LIGNIN	152.15		-108248	LIGNIN	+	8.5 O2 →	4 H2O	+	8 CO2			-874683	-0.874683	-10348	-916587	-0.916587	-10844		
ENZYME	24.02		-17900	ENZYME	+	1.1975 O2 →	0.795 H2O	+	1 CO2	+	0.12 N2	+	0.01 SO2						
DENZ	24.02		-17900	DENZ	+	1.1975 O2 →	0.795 H2O	+	1 CO2	+	0.12 N2	+	0.01 SO2	-122713	-0.122713	-9198	-130333	-0.130333	-9769
BIOMASS	23.24		-23200	BIOMASS	+	1.2185 O2 →	0.82 H2O	+	1 CO2	+	0.115 N2	+	0.0035 SO2	-118397	-0.118397	-9171	-126739	-0.126739	-9817
ZYMO	24.63		-31169	ZYMO	+	1.2 O2 →	0.9 H2O	+	1 CO2	+	0.1 N2			-114800	-0.114800	-8391	-124228	-0.124228	-9080
ACETATE	60.05	-103373	-108992	ACETATE	+	2 O2 →	2 H2O	+	2 CO2			-194497	-0.194497	-5830	-215449	-0.215449	-6458		
ARABINAN	132.12		-182100	ARABINAN	+	5 O2 →	4 H2O	+	5 CO2			-518866	-0.518866	-7069	-560770	-0.560770	-7640		
MANNAN	162.14		-233200	MANNAN	+	6 O2 →	5 H2O	+	6 CO2			-619511	-0.619511	-6877	-671890	-0.671890	-7459		
GALACTAN	162.14		-233200	GALACTAN	+	6 O2 →	5 H2O	+	6 CO2			-619511	-0.619511	-6877	-671890	-0.671890	-7459		
TAR	150.13		-182100	TAR	+	5 O2 →	5 H2O	+	5 CO2			-576623	-0.576623	-6913	-629002	-0.629002	-7541		
ASH	56.08	10485	-151688	NA															
TRICHO	23.82		-23200	TRICHO	+	1.19375 O2 →	0.8225 H2O	+	1 CO2	+	0.1025 N2	+	0.005 SO2	-118647	-0.118647	-8966	-126909	-0.126909	-9590
PROTEIN	22.84		-17618	PROTEIN	+	1.2445 O2 →	0.785 H2O	+	1 CO2	+	0.145 N2	+	0.007 SO2	-122205	-0.122205	-9631	-129932	-0.129932	-10240
CARBON	12.01			C	+	1 O2 →			1 CO2			-93988	-0.093988	-14085	-93988	-0.093988	-14085		
LIME	74.09	-145878	-235522	Ca(OH)2			1 H2O					26078	0.026078	634	15602	0.015602	379		
CASO4	136.14	-315682	-342531	CaSO4	+	-0.5 O2 →						119944	0.119944	1586	119944	0.119944	1586		

## Appendix E. Process Flow Diagrams

The full set of PFDs for this process follow. Space for stream tables was limited; below is a key to lumped components. See Section 5.1 for a discussion on how LHV is computed.

Other sugars (SS)	arabinose, mannose, galactose, cellobiose, sucrose
Sugar oligomers (SS)	oligomers of glucose, xylose, and all minor sugars
Organic soluble solids (SS)	ammonium acetate, solubilized lignin, organic extractives, lactic acid, cellulase and WWT nutrients
Inorganic soluble solids (SS)	ammonium sulfate, diammonium phosphate, sodium hydroxide, nitric acid, sodium nitrate
Furfurals	furfural, HMF
Other organics	glycerol, gasoline denaturant, corn oil, succinic acid, xylitol
CO/SO <sub>x</sub> /NO <sub>x</sub> /H <sub>2</sub> S	NO, NO <sub>2</sub> , SO <sub>2</sub> , CO, H <sub>2</sub> S
Other struct. carbohydr. (IS)	arabinan, mannan, galactan
Protein (IS)	corn protein, cellulase, denatured cellulase
Cell mass (IS)	WWT sludge, <i>Z. mobilis</i> from fermentation, <i>T. reesei</i> from cellulase production
Other insoluble solids (IS)	tar, ash, carbon, lime, gypsum

File Location: I:\1A - Process Solutions\10-30083\_NREL - Wastewater\5000\_PFDs\FINAL DRAWINGS FOR PUBLICATION\PTD-P120-A101.dwg  
 Plot Date: 4/27/11 By: Section Designer

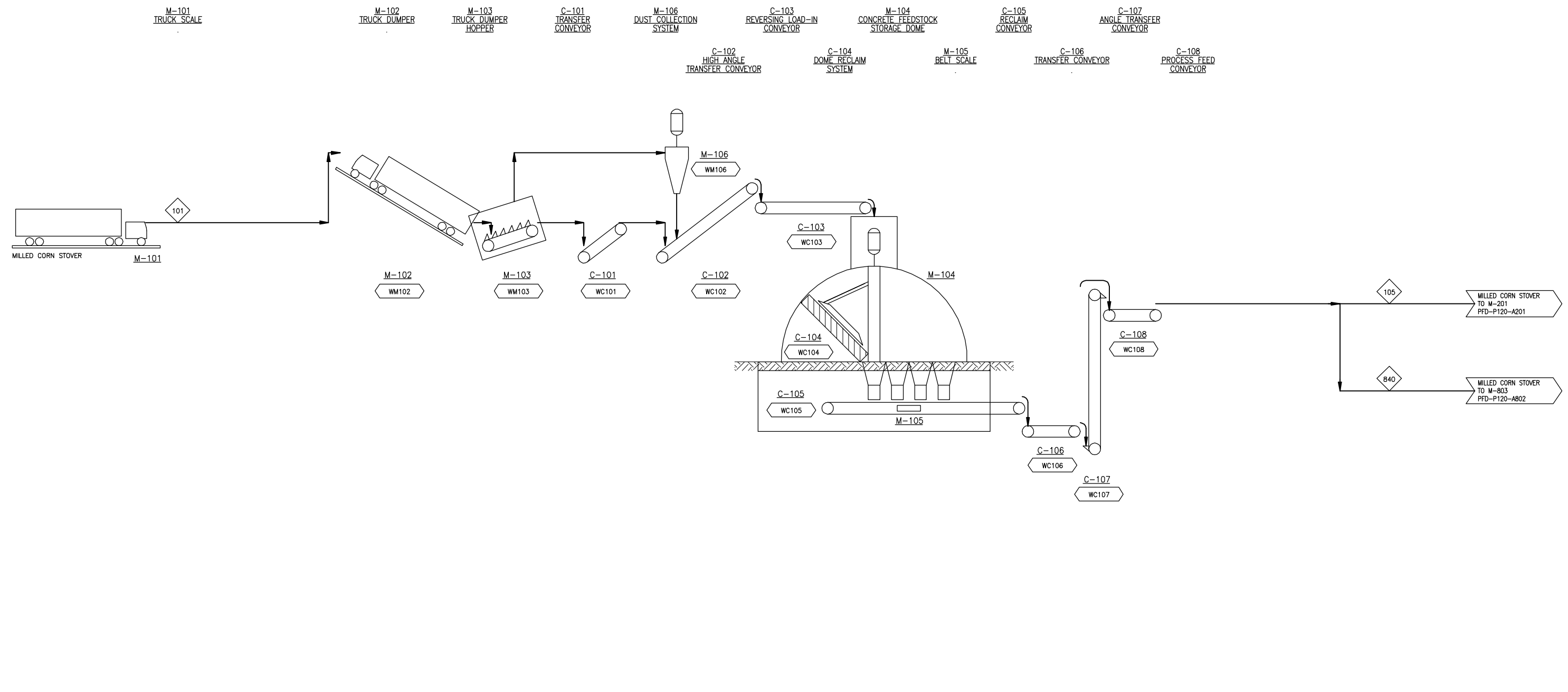

COMPONENT	UNITS	101	105	840
Total Flow	kg/hr	104.167	104.167	0
Insoluble Solids	%	67.7%	67.7%	0.0%
Soluble Solids	%	12.3%	12.3%	0.0%
Temperature	°C	25	25	25
Pressure	atm	1.0	1.0	1.0
Vapor Fraction		0.0	0.0	1.0
Ethanol	kg/hr			
Water	kg/hr	20,833	20,833	
Glucose (SS)	kg/hr			
Xylose (SS)	kg/hr			
Other sugars (SS)	kg/hr	642	642	
Sugar Oligomers (SS)	kg/hr			
Organic Soluble Solids (SS)	kg/hr	12,208	12,208	
Inorganic Soluble Solids (SS)	kg/hr			
Ammonia	kg/hr			
Acetic Acid	kg/hr			
Sulfuric Acid	kg/hr			
Furfurals	kg/hr			
Other Organics	kg/hr			
Carbon Dioxide	kg/hr			
Methane	kg/hr			0
O2	kg/hr			
N2	kg/hr			
CO/SOx/NOx/H2S	kg/hr			
Cellulose (IS)	kg/hr	29,205	29,205	
Xylan (IS)	kg/hr	16,273	16,273	
Other Struct. Carbohydr. (IS)	kg/hr	3,675	3,675	
Acetate (IS)	kg/hr	1,508	1,508	
Lignin (IS)	kg/hr	13,132	13,132	
Protein (IS)	kg/hr	2,583	2,583	
Cell Mass (IS)	kg/hr			
Other Insoluble Solids (IS)	kg/hr	4,108	4,108	
Carbon Mole Flow	kmol/hr	3,117	3,117	0
COD	kg/hr	101,238	101,238	0
LHV @ 25°C	Gcal/hr	-315.6	-315.6	0.0

Work Stream	kW	Gcal/hr
WC101	32	0.027
WC102	79	0.068
WC103	16	0.014
WC104	96	0.082
WC105	16	0.014
WC106	16	0.014
WC107	8	0.007
WC108	4	0.003
WM102	317	0.272
WM103	158	0.136
WM106	119	0.102



**NREL**  
NATIONAL RENEWABLE ENERGY LABORATORY



**Harris Group Inc.**  
Engineering for Optimum Performance®  
www.harrisgroup.com

Scale: NONE		Drawn: JMW	Engr: PWS/JCL
PMgr: DJD	Appr:	Check:	Check:
<b>NATIONAL RENEWABLE ENERGY LABORATORY GOLDEN, COLORADO</b>			
<b>2011 BIOCHEMICAL DESIGN REPORT</b>			
<b>PROCESS FLOW DIAGRAM SECTION A100 CORN STOVER FEED HANDLING</b>			
Project No.:	30083.00	Drawing:	PFD-P120-A101
Rev.	Date	By	Description

Pfd. Date: 4/27/11 By: Section: Dns/elle File Location: I:\1A - Process Solutions\10-30083 NREL - Wastewater\5000 PFDs\FINAL DRAWINGS FOR PUBLICATION\PFD-P120-A201.dwg

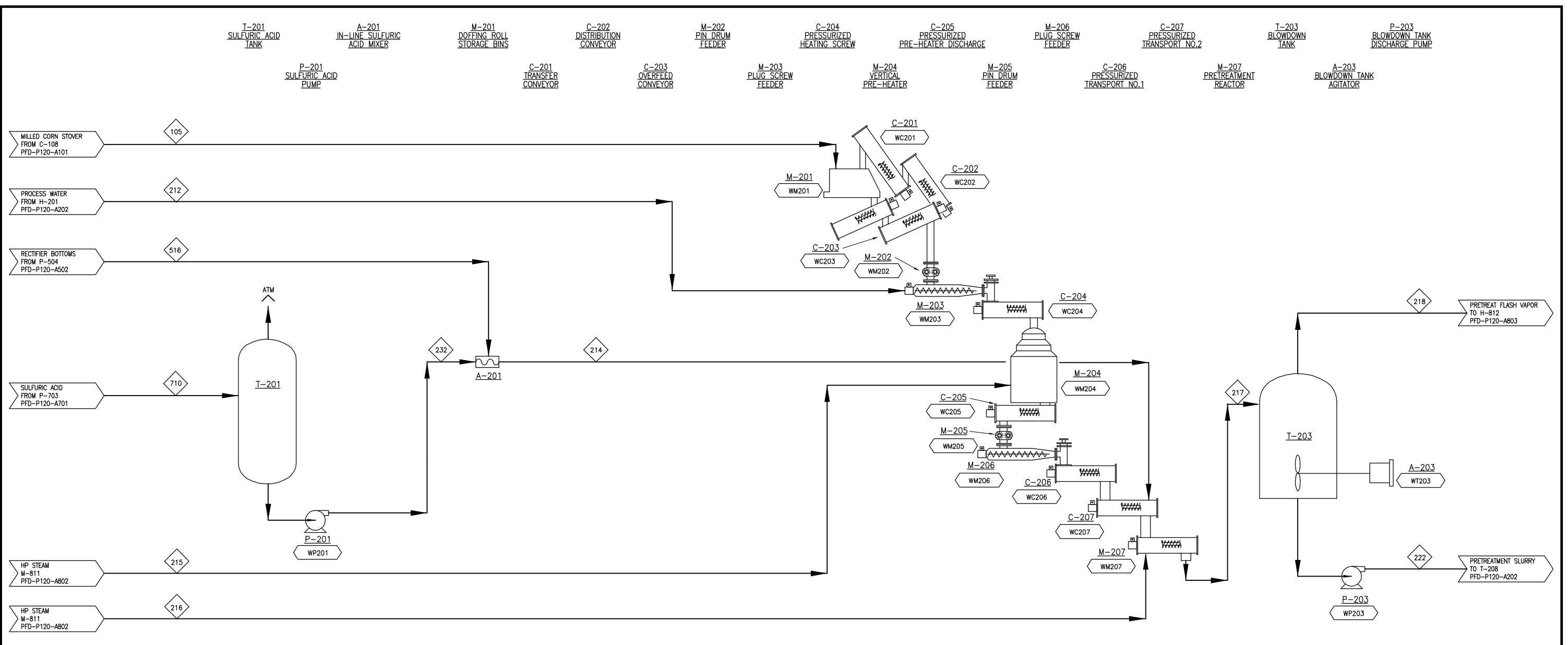

COMPONENT	UNITS	105	212	214	215	216	217	218	222	232	516	710
Total Flow	kg/hr	104,167	140,850	38,801	3,490	24,534	311,842	19,782	292,060	1,980	36,821	1,981
Insoluble Solids	%	67.7%	0.0%	0.0%	0.0%	0.0%	14.8%	0.0%	15.8%	0.0%	0.0%	0.0%
Soluble Solids	%	12.3%	0.0%	0.0%	0.0%	0.0%	12.0%	0.0%	12.8%	0.0%	0.0%	0.0%
Temperature	°C	25	95	113	268	268	158	130	130	22	114	21
Pressure	atm	1.0	4.7	6.1	13.0	13.0	5.7	2.6	9.6	11.8	6.1	5.4
Vapor Fraction		0.0	0.0	0.0	1.0	1.0	0.0	1.0	0.0	0.0	0.0	0.0
Ethanol	kg/hr			18			18	8	10		18	
Water	kg/hr	20,833	140,850	36,767	3,490	24,534	224,002	19,533	204,469	139	36,629	139
Glucose (SS)	kg/hr			0			3,550	0	3,550		0	
Xylose (SS)	kg/hr			0			16,643	0	16,643		0	
Other sugars (SS)	kg/hr	642		0			3,720	0	3,720		0	
Sugar Oligomers (SS)	kg/hr			0			566	0	566		0	
Organic Soluble Solids (SS)	kg/hr	12,208		1			12,866	0	12,866		1	
Inorganic Soluble Solids (SS)	kg/hr											
Ammonia	kg/hr			0			0	0	0		0	
Acetic Acid	kg/hr						1,508	36	1,473			
Sulfuric Acid	kg/hr			1,842			1,842	0	1,842	1,842		1,842
Furfurals	kg/hr			172			1,034	205	829		172	
Other Organics	kg/hr			0			0	0	0		0	
Carbon Dioxide	kg/hr											
Methane	kg/hr											
O2	kg/hr											
N2	kg/hr											
CO/SOx/NOx/H2S	kg/hr			0								0
Cellulose (IS)	kg/hr	29,205					26,138		26,138			
Xylan (IS)	kg/hr	16,273					423		423			
Other Struct. Carbohydr. (IS)	kg/hr	3,675					96		96			
Acetate (IS)	kg/hr	1,508										
Lignin (IS)	kg/hr	13,132					12,475		12,475			
Protein (IS)	kg/hr	2,583					2,583		2,583			
Cell Mass (IS)	kg/hr											
Other Insoluble Solids (IS)	kg/hr	4,108					4,377		4,377			
Carbon Mole Flow	kmol/hr	3,117		10			3,127	12	3,115		10	
COD	kg/hr	101,238		327			101,565	396	101,168		327	
LHV @ 25°C	Gcal/hr	-315.6	72.2	18.2	-0.4	-2.7	-231.7	-2.9	-230.0	1.2	16.9	1.2

Work Stream	kW	Gcal/hr
WC201	80	0.069
WC202	80	0.069
WC203	160	0.138
WC204	75	0.064
WC205	80	0.069
WC206	20	0.017
WC207	40	0.034
WM201	80	0.069
WM202	30	0.026
WM203	2000	1.720
WM204	45	0.039
WM205	30	0.026
WM206	2000	1.720
WM207	82	0.071
WP201	1	0.001
WP203	64	0.055
WT203	170	0.146



NATIONAL RENEWABLE ENERGY LABORATORY



www.harrisgroup.com

Scale: NONE  
 PMgr: DJD  
 Appr:

Drawn: JMW  
 Check:

Engr: PWS/JCL  
 Check:

**NATIONAL RENEWABLE ENERGY LABORATORY**  
**GOLDEN, COLORADO**

**2011 BIOCHEMICAL DESIGN REPORT**

**PROCESS FLOW DIAGRAM**  
**SECTION A200**  
**PRETREATMENT**

Rev.	Date	By	Description
E	4/27/11	HGI	UPDATED STREAM TABLES
D	4/21/11	HGI	ISSUED FOR 2011 DESIGN REPORT
C	4/6/11	HGI	ADDED STREAM TABLES
B	3/21/11	HGI	ADDED STREAM 216B
A	12/22/09	HGI	ISSUED FOR DESIGN REPORT

Project No.: 30083.00  
 Drawing: PFD-P120-A201  
 Rev: E

Ref. Date: 4/27/11  
 By: Section Designer  
 File Location: I:\1A - Process Solutions\10-30083 NREL - Wastewater\5000 PFDs\FINAL DRAWINGS FOR PUBLICATION\FD-P120-A202.dwg

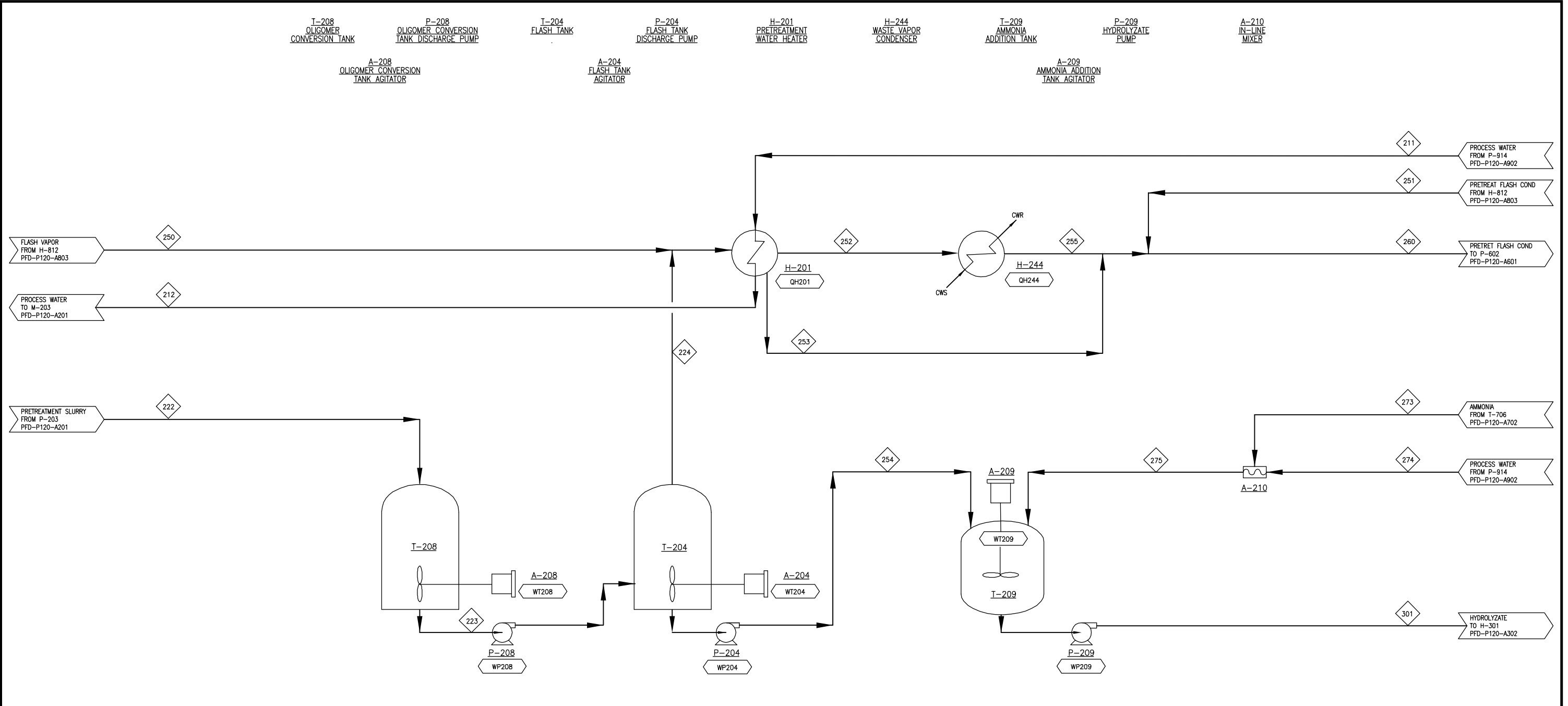

COMPONENT	UNITS	211	212	222	223	224	250	251	252	253	254	255	260	273	274	275	301
Total Flow	kg/hr	140,850	140,850	292,060	292,060	13,866	15,932	3,850	13,682	16,117	278,194	13,682	33,648	1,051	150,310	151,360	429,554
Insoluble Solids	%	0.0%	0.0%	15.8%	15.8%	0.0%	0.0%	0.0%	0.0%	0.0%	16.6%	0.0%	0.0%	0.0%	0.0%	0.0%	10.8%
Soluble Solids	%	0.0%	0.0%	12.8%	12.8%	0.0%	0.0%	0.0%	0.0%	0.0%	13.4%	0.0%	0.0%	0.0%	0.0%	0.0%	9.7%
Temperature	°C	33	95	130	131	101	100	100	100	100	97	99	100	20	33	36	78
Pressure	atm	5.0	4.7	9.6	5.7	1.0	1.0	1.0	1.0	1.0	1.0	1.0	1.0	9.0	5.0	5.0	4.3
Vapor Fraction		0.0	0.0	0.0	0.0	1.0	1.0	0.0	1.0	0.0	0.0	0.0	0.0	0.0	0.0	0.0	0.0
Ethanol	kg/hr			10	10	4	8	0	11	1	6	11	13				6
Water	kg/hr	140,850	140,850	204,469	204,469	13,715	15,702	3,831	13,382	16,035	190,754	13,382	33,248		150,310	150,310	341,063
Glucose (SS)	kg/hr			3,550	3,550	0	0	0	0	0	3,550	0	0				3,550
Xylose (SS)	kg/hr			16,643	16,643	0	0	0	0	0	16,643	0	0				16,476
Other sugars (SS)	kg/hr			3,720	3,720	0	0	0	0	0	3,720	0	0				3,682
Sugar Oligomers (SS)	kg/hr			566	566	0	0	0	0	0	566	0	0				566
Organic Soluble Solids (SS)	kg/hr			12,866	12,866	0	0	0	0	0	12,866	0	0				14,727
Inorganic Soluble Solids (SS)	kg/hr																2,482
Ammonia	kg/hr			0	0	0	0	0	0	0	0	0	0	1,051		1,051	
Acetic Acid	kg/hr			1,473	1,473	23	25	11	15	32	1,450	15	58				
Sulfuric Acid	kg/hr			1,842	1,842	0	0	0	0	0	1,842	0	0				
Furfurals	kg/hr			829	829	124	197	8	274	48	705	274	329				705
Other Organics	kg/hr			0	0	0	0	0	0	0	0	0	0				0
Carbon Dioxide	kg/hr																
Methane	kg/hr																
O2	kg/hr																
N2	kg/hr																
CO/SOx/NOx/H2S	kg/hr																
Cellulose (IS)	kg/hr			26,138	26,138						26,138						26,138
Xylan (IS)	kg/hr			423	423						423						423
Other Struct. Carbohydr. (IS)	kg/hr			96	96						96						96
Acetate (IS)	kg/hr																
Lignin (IS)	kg/hr			12,475	12,475						12,475						12,475
Protein (IS)	kg/hr			2,583	2,583						2,583						2,583
Cell Mass (IS)	kg/hr																
Other Insoluble Solids (IS)	kg/hr			4,377	4,377						4,377						4,581
Carbon Mole Flow	kmol/hr			3,115	3,115	7	11	4	15	4	3,107	15	20				3,107
COD	kg/hr			101,168	101,168	239	372	25	495	116	100,929	495	636				100,929
LHV @ 25°C	Gcal/hr	80.9	72.2	-230.0	-230.2	-1.5	-1.7	1.9	-2.1	7.8	-228.9	5.1	14.8	-4.4	86.3	81.3	-147.2

Heat Stream	Gcal/hr	Work Stream	kW	Gcal/hr
QH201	-8.636	WVP204	56	0.048
QH244	7.276	WVP208	100	0.086
		WVP209	90	0.077
		WT204	127	0.109
		WT208	127	0.109
		WT209	90	0.077

E	4/27/11	HGI	UPDATED STREAM TABLES
D	4/21/11	HGI	ISSUED FOR 2011 DESIGN REPORT
C	4/6/11	HGI	ADDED STREAM TABLES
B	3/21/11	HGI	REVISED BASED ON NEW WWT DESIGN
A	12/22/09	HGI	ISSUED FOR DESIGN REPORT
Rev.	Date	By	Description

www.harrisgroup.com

Scale: NONE  
 PMgr: DJD  
 Appr:

Drawn: JMW  
 Check:

Engr: PWS/JCL  
 Check:

**NATIONAL RENEWABLE ENERGY LABORATORY**  
**GOLDEN, COLORADO**

**2011 BIOCHEMICAL DESIGN REPORT**

**PROCESS FLOW DIAGRAM**  
**SECTION A200**  
**AMMONIA ADDITION**

Project No.: 30083.00  
 Drawing: PFD-P120-A202  
 Rev:

File Location: \\A:\Process Solutions\10-30083\_NREL - Wastewater\5000 PFDs\FINAL DRAWINGS FOR PUBLICATION\FD-P120-A301.dwg  
 Br. Section: Dns@le  
 Pfd. Date: 4/27/11

F-301 1ST SEED FERMENTOR      F-303 3RD SEED FERMENTOR      F-305 5TH SEED FERMENTOR      H-304 4TH SEED FERMENTOR COIL      A-304 4TH SEED VESSEL AGITATOR      P-302 SEED TRANSFER PUMP      T-301 SEED HOLD TANK      A-301 SEED HOLD TANK AGITATOR      P-301 SEED HOLD TRANSFER PUMP  
 F-302 2ND SEED FERMENTOR      F-304 4TH SEED FERMENTOR      H-305 5TH SEED FERMENTOR COIL      A-305 5TH SEED VESSEL AGITATOR

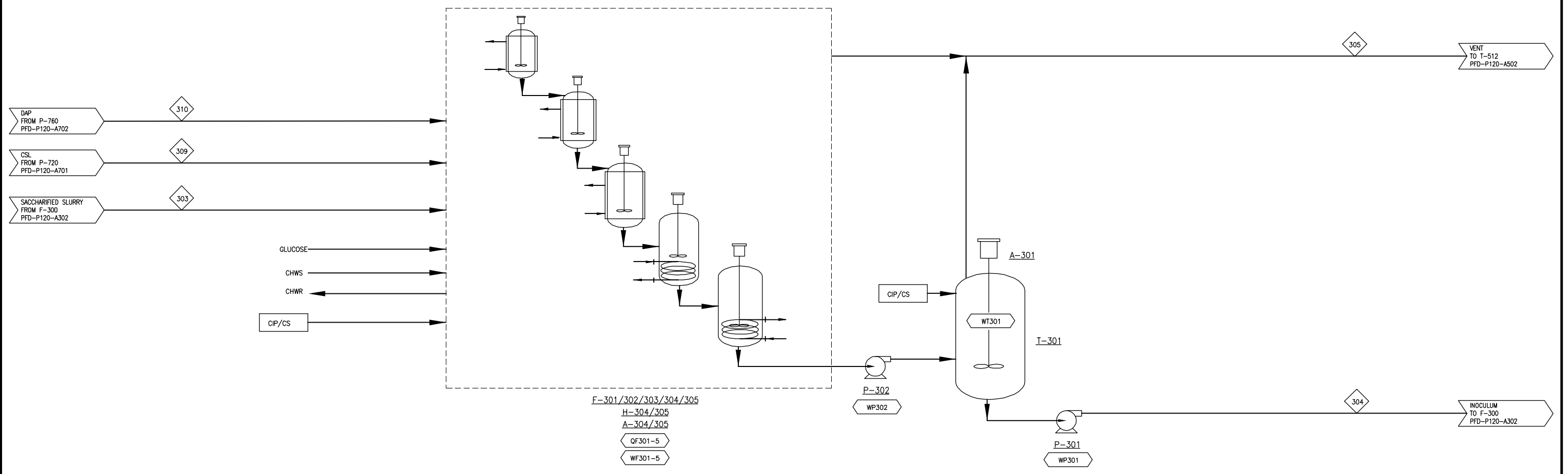

COMPONENT	UNITS	303	304	305	309	310
Total Flow	kg/hr	44,339	42,607	1,969	211	26
Insoluble Solids	%	5.0%	5.7%	0.0%	25.0%	0.0%
Soluble Solids	%	15.6%	6.3%	0.0%	24.8%	100.0%
Temperature	°C	32	33	32	20	20
Pressure	atm	1.0	5.0	1.0	1.0	1.0
Vapor Fraction		0.0	0.0	1.0	0.0	0.0
Ethanol	kg/hr	1	2,009	32		
Water	kg/hr	35,149	35,248	38	106	
Glucose (SS)	kg/hr	2,969	148	0		
Xylose (SS)	kg/hr	1,648	168	0		
Other sugars (SS)	kg/hr	401	401	0		
Sugar Oligomers (SS)	kg/hr	161	161	0		
Organic Soluble Solids (SS)	kg/hr	1,477	1,529	0	52	
Inorganic Soluble Solids (SS)	kg/hr	248	272			26
Ammonia	kg/hr	0	0	0		
Acetic Acid	kg/hr					
Sulfuric Acid	kg/hr					
Furfurals	kg/hr	71	70	0		
Other Organics	kg/hr	1	138	0		
Carbon Dioxide	kg/hr	0	51	1,882		
Methane	kg/hr					
O2	kg/hr	0	0	17		
N2	kg/hr	0	0	0		
CO/SOx/NOx/H2S	kg/hr	0	0	0		
Cellulose (IS)	kg/hr	125	125			
Xylan (IS)	kg/hr	42	42			
Other Struct. Carbohydr. (IS)	kg/hr	10	10			
Acetate (IS)	kg/hr					
Lignin (IS)	kg/hr	1,248	1,248			
Protein (IS)	kg/hr	320	364		53	
Cell Mass (IS)	kg/hr	11	162			
Other Insoluble Solids (IS)	kg/hr	458	458			
Carbon Mole Flow	kmol/hr	314	273	44	4	
COD	kg/hr	10,201	10,280	67	132	
LHV @ 25°C	Gcal/hr	-12.7	-12.6	-0.2	-0.4	0.0

Heat Stream	Gcal/hr	Work Stream	kW	Gcal/hr
QF301-5	0.451	WF301-5	99	0.085
		WP301	7	0.006
		WP302	7	0.006
		WT301	15	0.013



NATIONAL RENEWABLE ENERGY LABORATORY



Harris Group Inc.  
Engineering for Optimum Performance®  
www.harrisgroup.com

Scale: NONE  
 PMgr: DJD      Drawn: JMW      Engr: PWS/JCL  
 Appr:              Check:              Check:

**NATIONAL RENEWABLE ENERGY LABORATORY  
GOLDEN, COLORADO**

**2011 BIOCHEMICAL DESIGN REPORT**

**PROCESS FLOW DIAGRAM  
SECTION A300  
SEED PRODUCTION**

Project No.: 30083.00	Drawn: PFD-P120-A301	Rev: 
-----------------------	----------------------	--

Rev.	Date	By	Description
D	4/27/11	HGI	UPDATED STREAM TABLES
C	4/21/11	HGI	ISSUED FOR 2011 DESIGN REPORT
B	4/6/11	HGI	ADDED STREAM TABLES
A	12/22/09	HGI	ISSUED FOR DESIGN REPORT



File Location: I:\1A - Process Solutions\10-30083 NREL - Wastewater\5000 PFDs\FINAL DRAWINGS FOR PUBLICATION\FD-P120-A302.dwg  
 Br. Section: Dns/elle  
 Pfd. Date: 4/27/11

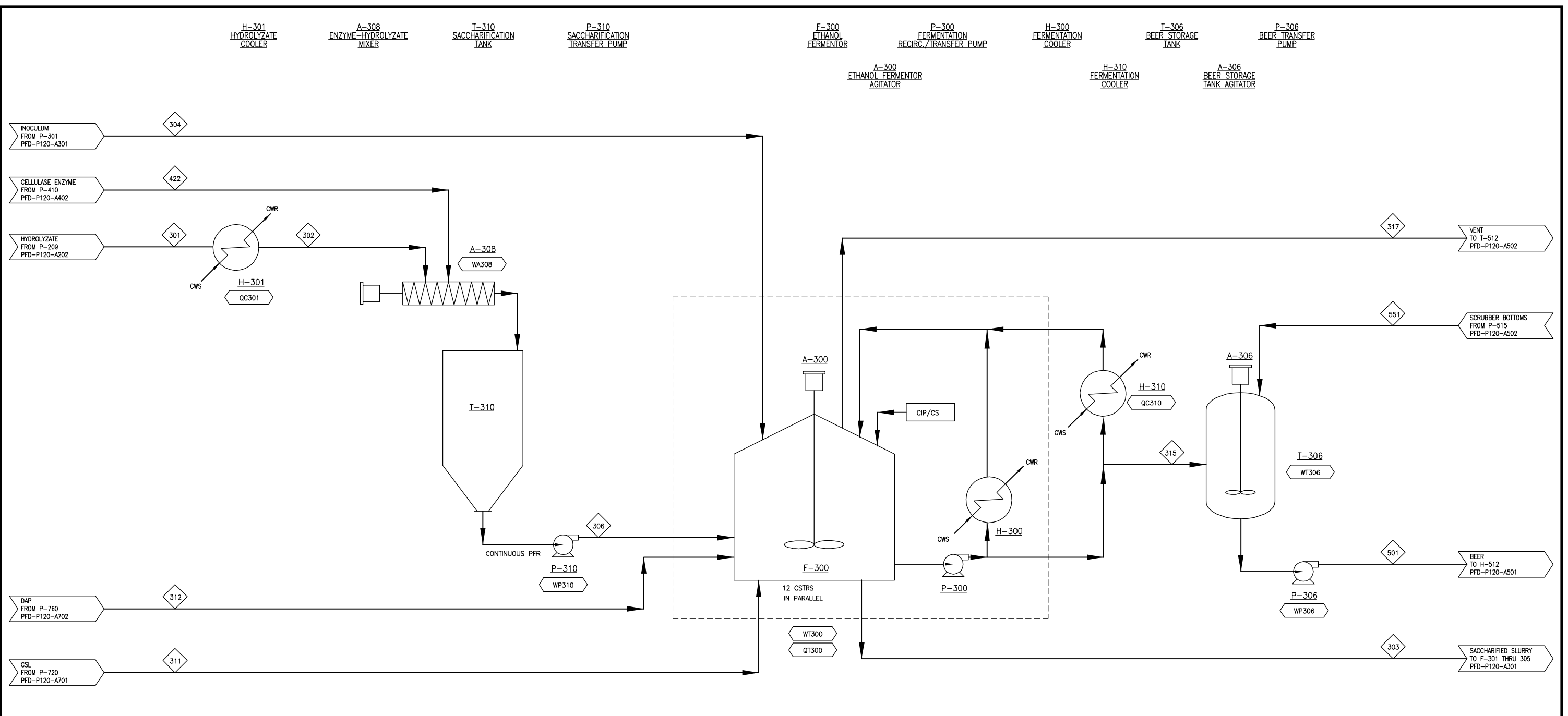

COMPONENT	UNITS	301	302	303	304	306	311	312	315	317	422	501	551
Total Flow	kg/hr	429,554	429,554	44,339	42,607	443,391	948	116	423,542	19,180	13,836	450,740	27,197
Insoluble Solids	%	10.8%	10.8%	5.0%	5.7%	10.6%	25.0%	0.0%	5.5%	0.0%	5.3%	5.2%	0.0%
Soluble Solids	%	9.7%	9.7%	15.6%	6.3%	9.4%	24.7%	100.0%	5.8%	0.0%	0.3%	5.4%	0.0%
Temperature	°C	78	49	32	33	48	20	20	32	32	29	32	34
Pressure	atm	4.3	2.5	1.0	5.0	5.1	1.0	1.0	1.0	1.0	1.9	6.0	4.3
Vapor Fraction		0.0	0.0	0.0	0.0	0.0	0.0	0.0	0.0	1.0	0.0	0.0	0.0
Ethanol	kg/hr	6	6	1	2,009	6			21,517	331		21,941	424
Water	kg/hr	341,063	341,063	35,149	35,248	354,117	476		351,782	369	13,054	378,525	26,743
Glucose (SS)	kg/hr	3,550	3,550	2,969	148	3,550			521	0		521	
Xylose (SS)	kg/hr	16,476	16,476	1,648	168	16,476			1,062	0		1,062	0
Other sugars (SS)	kg/hr	3,682	3,682	401	401	3,682			2,175	0		2,175	0
Sugar Oligomers (SS)	kg/hr	566	566	161	161	566			1,612	0		1,612	0
Organic Soluble Solids (SS)	kg/hr	14,727	14,727	1,477	1,529	14,768	235		16,421	0	41	16,421	0
Inorganic Soluble Solids (SS)	kg/hr	2,482	2,482	248	272	2,482		116	2,610			2,610	
Ammonia	kg/hr			0	0	0			0	0	0	0	0
Acetic Acid	kg/hr												
Sulfuric Acid	kg/hr												
Furfurals	kg/hr	705	705	71	70	705			703	2		706	3
Other Organics	kg/hr	0	0	1	138	13			1,400	0	13	1,400	0
Carbon Dioxide	kg/hr			0	51	1			520	18,323	1	549	28
Methane	kg/hr												
O2	kg/hr			0	0	0			0	155	0	0	0
N2	kg/hr			0	0	0			0	0	0	0	0
CO/SOx/NOx/H2S	kg/hr			0	0	0			0	0	0	0	0
Cellulose (IS)	kg/hr	26,138	26,138	125	125	26,138			1,255			1,255	
Xylan (IS)	kg/hr	423	423	42	42	423			423			423	
Other Struct. Carbohydr. (IS)	kg/hr	96	96	10	10	96			96			96	
Acetate (IS)	kg/hr												
Lignin (IS)	kg/hr	12,475	12,475	1,248	1,248	12,475			12,475			12,475	
Protein (IS)	kg/hr	2,583	2,583	320	364	3,203	237		3,445		620	3,445	
Cell Mass (IS)	kg/hr			11	162	108			944		108	944	
Other Insoluble Solids (IS)	kg/hr	4,581	4,581	458	468	4,581			4,581			4,581	
Carbon Mole Flow	kmol/hr	3,107	3,107	314	273	3,140	18		2,685	431	33	2,704	19
COD	kg/hr	100,929	100,929	10,201	10,280	102,010	592		102,130	693	1,081	103,018	888
LHV @ 25°C	Gcal/hr	-147.2	-136.5	-12.7	-12.6	-133.1	-1.7	0.0	-123.0	-2.1	3.6	-110.5	12.6

Heat Stream	Gcal/hr	Work Stream	kW	Gcal/hr
QC301	10.636	WA308	75	0.064
QT300	4.417	WP306	106	0.091
QC310	5.946	WP310	55	0.047
		WT300	1354	1.164
		WT306	15	0.013



**NREL**  
NATIONAL RENEWABLE ENERGY LABORATORY



**Harris Group Inc.**  
Engineering for Optimum Performance®  
www.harrisgroup.com

Scale: NONE  
 PMgr: DJD      Drawn: JMW      Engr: PWS/JCL  
 Appr:              Check:              Check:

**NATIONAL RENEWABLE ENERGY LABORATORY**  
**GOLDEN, COLORADO**

**2011 BIOCHEMICAL DESIGN REPORT**

**PROCESS FLOW DIAGRAM**  
**SECTION A300**  
**SACCHARIFICATION & FERMENTATION**

Rev.	Date	By	Description
D	4/27/11	HGI	UPDATED STREAM TABLES
C	4/21/11	HGI	ISSUED FOR 2011 DESIGN REPORT
B	4/5/11	HGI	ADDED STREAM TABLES
A	12/22/09	HGI	ISSUED FOR DESIGN REPORT

Project No.:	30083.00	Drawing:	<b>PFD-P120-A302</b>	Rev:	<b>D</b>
--------------	----------	----------	----------------------	------	----------

File Location: U:\1A - Process Solutions\1D-30083 NREL - Wastewater\5000 PFDs\FINAL DRAWINGS FOR PUBLICATION\FD-P120-A401.dwg  
 Br. Section: Dnsible  
 Pld. Date: 4/27/11

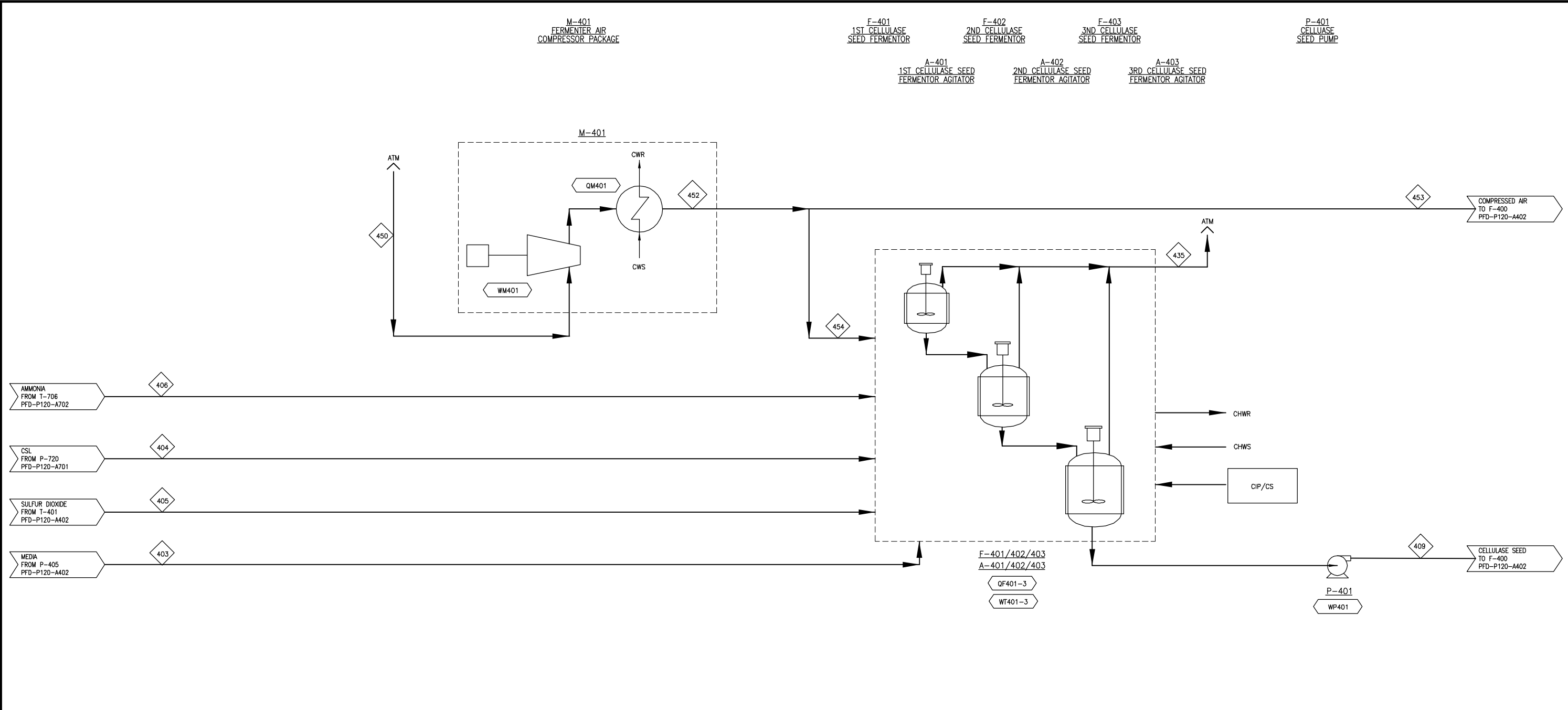

COMPONENT	UNITS	403	404	405	406	409	435	450	452	453	454
Total Flow	kg/hr	790	8	0	6	770	1,586	32,583	32,583	31,031	1,552
Insoluble Solids	%	0.5%	25.0%	0.0%	0.0%	5.3%	0.0%	0.0%	0.0%	0.0%	0.0%
Soluble Solids	%	15.3%	24.7%	0.0%	0.0%	1.9%	0.0%	0.0%	0.0%	0.0%	0.0%
Temperature	°C	62	20	28	28	28	28	25	40	40	40
Pressure	atm	3.0	1.0	3.0	9.0	2.0	1.0	1.0	3.0	3.0	3.0
Vapor Fraction		0.0	0.0	1.0	1.0	0.0	1.0	1.0	1.0	1.0	1.0
Ethanol	kg/hr										
Water	kg/hr	665	4			714	37	638	638	608	30
Glucose (SS)	kg/hr	121				12	0				
Xylose (SS)	kg/hr										
Other sugars (SS)	kg/hr										
Sugar Oligomers (SS)	kg/hr										
Organic Soluble Solids (SS)	kg/hr	0	2			2	0				
Inorganic Soluble Solids (SS)	kg/hr										
Ammonia	kg/hr	0			6	0	0				
Acetic Acid	kg/hr										
Sulfuric Acid	kg/hr										
Furfurals	kg/hr										
Other Organics	kg/hr	0				0	0				
Carbon Dioxide	kg/hr	0				0	95				
Methane	kg/hr										
O2	kg/hr	0				0	287	7,440	7,440	7,086	354
N2	kg/hr	0				0	1,167	24,504	24,504	23,337	1,167
CO/SOx/NOx/H2S	kg/hr	0		0		0	0				
Cellulose (IS)	kg/hr										
Xylan (IS)	kg/hr										
Other Struct. Carbohydr. (IS)	kg/hr										
Acetate (IS)	kg/hr										
Lignin (IS)	kg/hr										
Protein (IS)	kg/hr	3	2			7					
Cell Mass (IS)	kg/hr	1				34					
Other Insoluble Solids (IS)	kg/hr										
Carbon Mole Flow	kmol/hr	4	0			2	2				
COD	kg/hr	135	5	0		73	0				
LHV @ 25°C	Gcal/hr	-0.1	0.0	0.0	0.0	0.2	0.0	0.0	0.0	0.0	0.0

Heat Stream	Gcal/hr	Work Stream	kW	Gcal/hr
QM401	1.172	WM401	1408	1.211
QF401-3	0.468	WP401	0	0.000
		WT401-3	232	0.200

Scale: NONE PMgr: DJD Appr:			
Drawn: JMW Check:		Engr: PWS/JCL Check:	
<b>NATIONAL RENEWABLE ENERGY LABORATORY</b> <b>GOLDEN, COLORADO</b>			
<b>2011 BIOCHEMICAL DESIGN REPORT</b>			
<b>PROCESS FLOW DIAGRAM</b> <b>SECTION A400</b> <b>CELLULOSE SEED FERMENTATION</b>			
Project No.: 30083.00		Drawing: PFD-P120-A401	
Rev.	Date	By	Description
D	4/27/11	HGI	UPDATED STREAM TABLES
C	4/21/11	HGI	ISSUED FOR 2011 DESIGN REPORT
B	4/6/11	HGI	ADDED STREAM TABLES
A	12/22/09	HGI	ISSUED FOR DESIGN REPORT

Ref. Date: 4/27/11  
 By: Section: Dursille  
 File Location: I:\1A - Process Solutions\10-30083\_NREL - Wastewater\5000\_PFDs\FINAL DRAWINGS FOR PUBLICATION\FPD-P120-A402.dwg

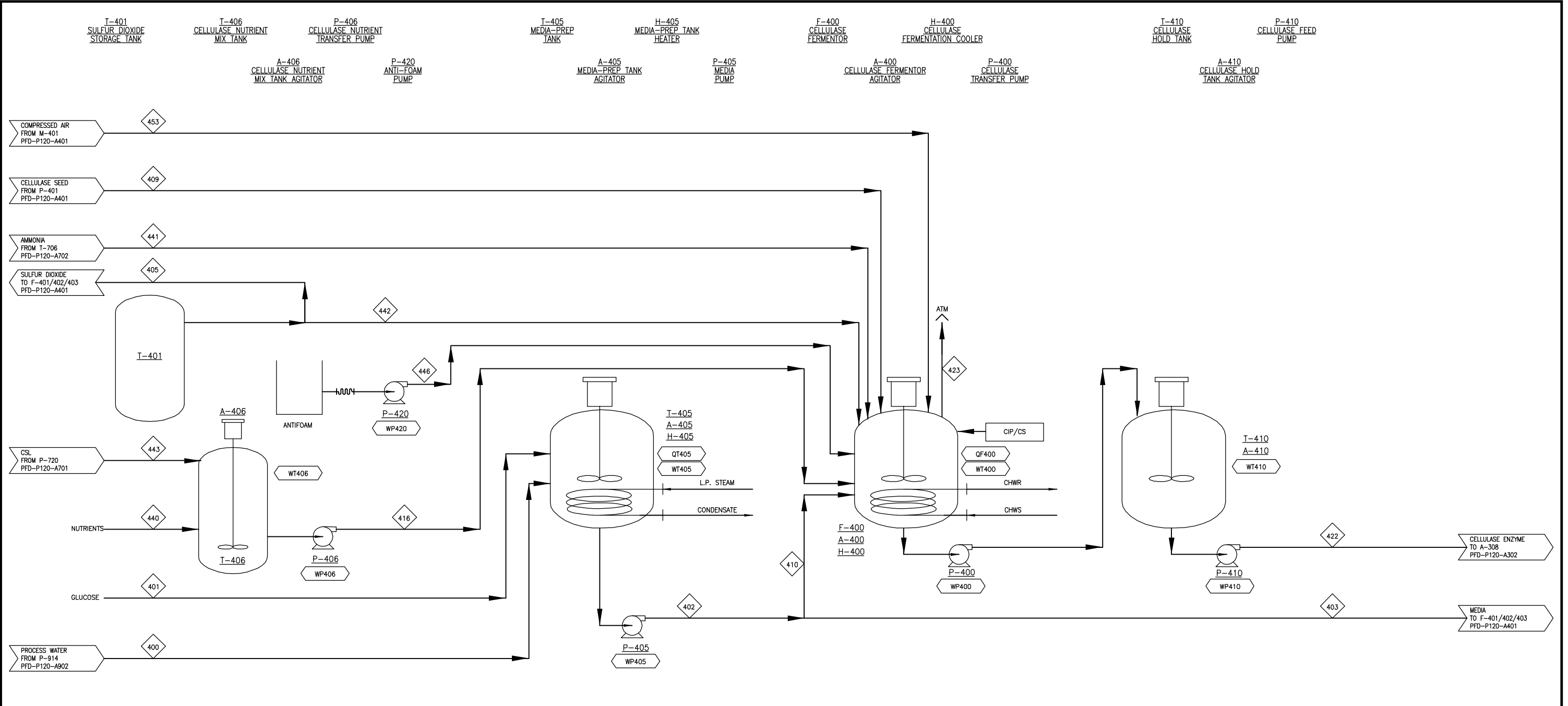

COMPONENT	UNITS	400	401	402	403	405	409	410	416	422	423	440	441	442	443	446	453
Total Flow	kg/hr	11,419	2,845	15,801	790	0	770	15,011	224	13,836	31,801	67	109	16	157	13	31,031
Insoluble Solids	%	0.0%	0.0%	0.5%	0.5%	0.0%	5.3%	0.5%	17.5%	5.3%	0.0%	0.0%	0.0%	0.0%	25.0%	0.0%	0.0%
Soluble Solids	%	0.0%	85.0%	15.3%	15.3%	0.0%	1.9%	15.3%	47.4%	0.3%	100.0%	0.0%	0.0%	0.0%	24.7%	0.0%	0.0%
Temperature	°C	33	28	62	62	28	28	62	34	29	28	20	28	28	20	20	40
Pressure	atm	5.0	1.0	3.0	3.0	3.0	2.0	3.0	2.0	1.9	1.0	1.0	9.0	3.0	1.0	3.2	3.0
Vapor Fraction		0.0	0.0	0.0	0.0	1.0	0.0	0.0	0.0	0.0	1.0	0.0	1.0	1.0	0.0	0.0	1.0
Ethanol	kg/hr						714	12,631	79	13,054	737				79		608
Water	kg/hr	11,419	427	13,296	665												
Glucose (SS)	kg/hr		2,418	2,418	121		12	2,297									
Xylose (SS)	kg/hr																
Other sugars (SS)	kg/hr																
Sugar Oligomers (SS)	kg/hr																
Organic Soluble Solids (SS)	kg/hr			5	0		2	4	106	41	0	67			39		
Inorganic Soluble Solids (SS)	kg/hr																
Ammonia	kg/hr			0	0		0	0					109				
Acetic Acid	kg/hr																
Sulfuric Acid	kg/hr																
Furfurals	kg/hr																
Other Organics	kg/hr			1	0		0	1		13	0					13	
Carbon Dioxide	kg/hr			0	0		0	0		1	2,287						
Methane	kg/hr																
O2	kg/hr			0	0		0	0		0	5,440						7,086
N2	kg/hr			0	0		0	0		0	23,337						23,337
CO/SOx/NOx/H2S	kg/hr			0	0	0	0	0		0	0			16			
Cellulose (IS)	kg/hr																
Xylan (IS)	kg/hr																
Other Struct. Carbohydr. (IS)	kg/hr																
Acetate (IS)	kg/hr																
Lignin (IS)	kg/hr																
Protein (IS)	kg/hr			69	3		7	65	39	620					39		
Cell Mass (IS)	kg/hr			12	1		34	11		108							
Other Insoluble Solids (IS)	kg/hr																
Carbon Mole Flow	kmol/hr		81	84	4		2	80	5	33	52	2		3	1		
COD	kg/hr		2,577	2,697	135	0	73	2,562	170	1,081	0	72		4	98	39	
LHV @ 25°C	Gcal/hr		6.6	-7.9	-1.4	-0.1	0.0	0.2	-1.3	-0.5	3.6	0.0	-0.2	-0.5	0.0	-0.3	-0.1

Heat Stream	Gcal/hr	Work Stream	kW	Gcal/hr
QF400	8.104	WP400	1	0.001
QT405	-0.414	WP405	2	0.002
		WP406	0	0.000
		WP410	1	0.001
		WP420	0	0.000
		WT400	2093	1.800
		WT405	6	0.005
		WT406	2	0.002
		WT410	7	0.006



NATIONAL RENEWABLE ENERGY LABORATORY



Harris Group Inc.  
Engineering for Optimum Performance®  
www.harrisgroup.com

Scale: NONE  
 PMgr: DJD  
 Appr:

Drawn: JMW  
 Check:

Engr: PWS/JCL  
 Check:

**NATIONAL RENEWABLE ENERGY LABORATORY**  
**GOLDEN, COLORADO**

**2011 BIOCHEMICAL DESIGN REPORT**

**PROCESS FLOW DIAGRAM**  
**SECTION 400**  
**CELLULOSE PRODUCT FERMENTATION**

Rev.	Date	By	Description
D	4/27/11	HGI	UPDATED STREAM TABLES
C	4/21/11	HGI	ISSUED FOR 2011 DESIGN REPORT
B	4/6/11	HGI	ADDED STREAM TABLES
A	12/22/09	HGI	ISSUED FOR DESIGN REPORT

Project No.: 30083.00

Drawing: PFD-P120-A402

Rev: D

Ref: Date: 4/27/11 By: Section: Distillation File Location: I:\1A - Process Solutions\10-30083 NREL - Wastewater\5000 PFDs\FINAL DRAWINGS FOR PUBLICATION\PFD-P120-A501.dwg

H-512 BEER COLUMN FEED INTERCHANGER      P-506 BEER COLUMN BOTTOMS STILLAGE PUMP      D-501 BEER COLUMN      P-501 BEER COLUMN BOTTOMS RECYCLE PUMP      H-501 BEER COLUMN REBOILER      P-503 BEER COLUMN REFUX PUMP      T-503 BEER COLUMN REFUX DRUM      H-504 BEER COLUMN CONDENSER

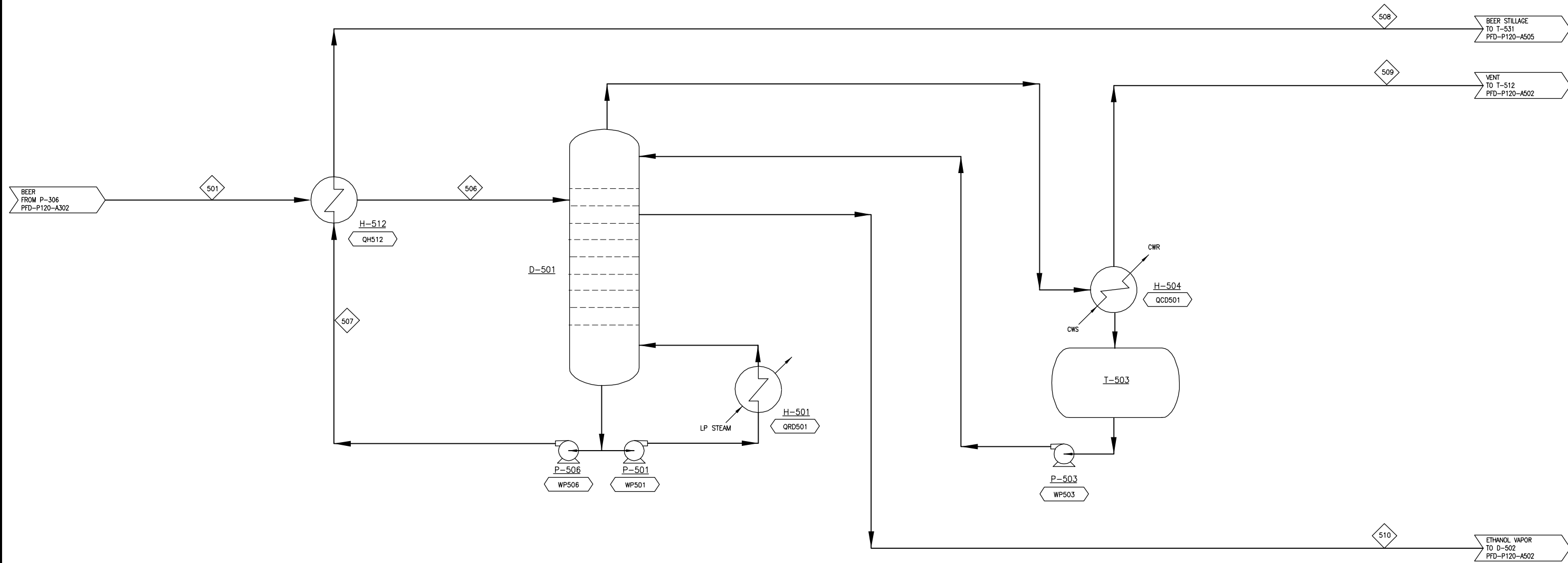

COMPONENT	UNITS	501	506	507	508	509	510
Total Flow	kg/hr	450,740	450,740	391,501	391,501	610	58,629
Insoluble Solids	%	5.2%	5.2%	5.9%	5.9%	0.0%	0.0%
Soluble Solids	%	5.4%	5.4%	6.2%	6.2%	0.0%	0.0%
Temperature	°C	32	103	125	47	60	117
Pressure	atm	6.0	6.0	6.3	6.3	2.0	2.1
Vapor Fraction		0.0	0.0	0.0	0.0	1.0	1.0
Ethanol	kg/hr	21,941	21,941	184	184	66	21,691
Water	kg/hr	378,525	378,525	341,765	341,765	23	36,737
Glucose (SS)	kg/hr	521	521	521	521	0	0
Xylose (SS)	kg/hr	1,062	1,062	1,062	1,062	0	0
Other sugars (SS)	kg/hr	2,175	2,175	2,175	2,175	0	0
Sugar Oligomers (SS)	kg/hr	1,612	1,612	1,612	1,612	0	0
Organic Soluble Solids (SS)	kg/hr	16,421	16,421	16,420	16,420	0	1
Inorganic Soluble Solids (SS)	kg/hr	2,610	2,610	2,610	2,610	0	0
Ammonia	kg/hr	0	0	0	0	0	0
Acetic Acid	kg/hr						
Sulfuric Acid	kg/hr						
Furfurals	kg/hr	706	706	533	533	0	172
Other Organics	kg/hr	1,400	1,400	1,400	1,400	0	0
Carbon Dioxide	kg/hr	549	549			522	27
Methane	kg/hr						
O2	kg/hr	0	0	0	0	0	0
N2	kg/hr	0	0	0	0	0	0
CO/SOx/NOx/H2S	kg/hr	0	0	0	0	0	0
Cellulose (IS)	kg/hr	1,255	1,255	1,255	1,255		
Xylan (IS)	kg/hr	423	423	423	423		
Other Struct. Carbohydr. (IS)	kg/hr	96	96	96	96		
Acetate (IS)	kg/hr						
Lignin (IS)	kg/hr	12,475	12,475	12,475	12,475		
Protein (IS)	kg/hr	3,445	3,445	3,445	3,445		
Cell Mass (IS)	kg/hr	944	944	944	944		
Other Insoluble Solids (IS)	kg/hr	4,581	4,581	4,581	4,581		
Carbon Mole Flow	kmol/hr	2,704	2,704	1,738	1,738	15	951
COD	kg/hr	103,018	103,018	57,393	57,393	137	45,489
LHV @ 25°C	Gcal/hr	-110.5	-139.9	-25.6	3.8	-0.4	-137.3

Heat Stream	Gcal/hr	Work Stream	kW	Gcal/hr
QCD501	0.462	WP501	309	0.266
QH512	29.396	WP503	1	0.000
QRD501	-33.022	WP506	56	0.048



**Harris Group Inc.**  
 Engineering for Optimum Performance®  
 www.harrisgroup.com

Scale: NONE  
 PMgr: DJD      Drawn: JMW      Engr: PWS/JCL  
 Appr:              Check:              Check:

**NATIONAL RENEWABLE ENERGY LABORATORY**  
**GOLDEN, COLORADO**

**2011 BIOCHEMICAL DESIGN REPORT**

**PROCESS FLOW DIAGRAM**  
**SECTION A500**  
**BEER DISTILLATION**

Rev.	Date	By	Description
D	4/27/11	HGI	UPDATED STREAM TABLES
C	4/21/11	HGI	ISSUED FOR 2011 DESIGN REPORT
B	4/6/11	HGI	ADDED STREAM TABLES
A	12/22/09	HGI	ISSUED FOR DESIGN REPORT

Project No.: 30083.00      Drawing: PFD-P120-A501      Rev: D

Ref. Date: 4/27/11  
 By: Section Designer  
 File Location: U:\1A - Process Solutions\10-30083 NREL - Wastewater\5000 PFDs\FINAL DRAWINGS FOR PUBLICATION\FD-P120-A502.dwg

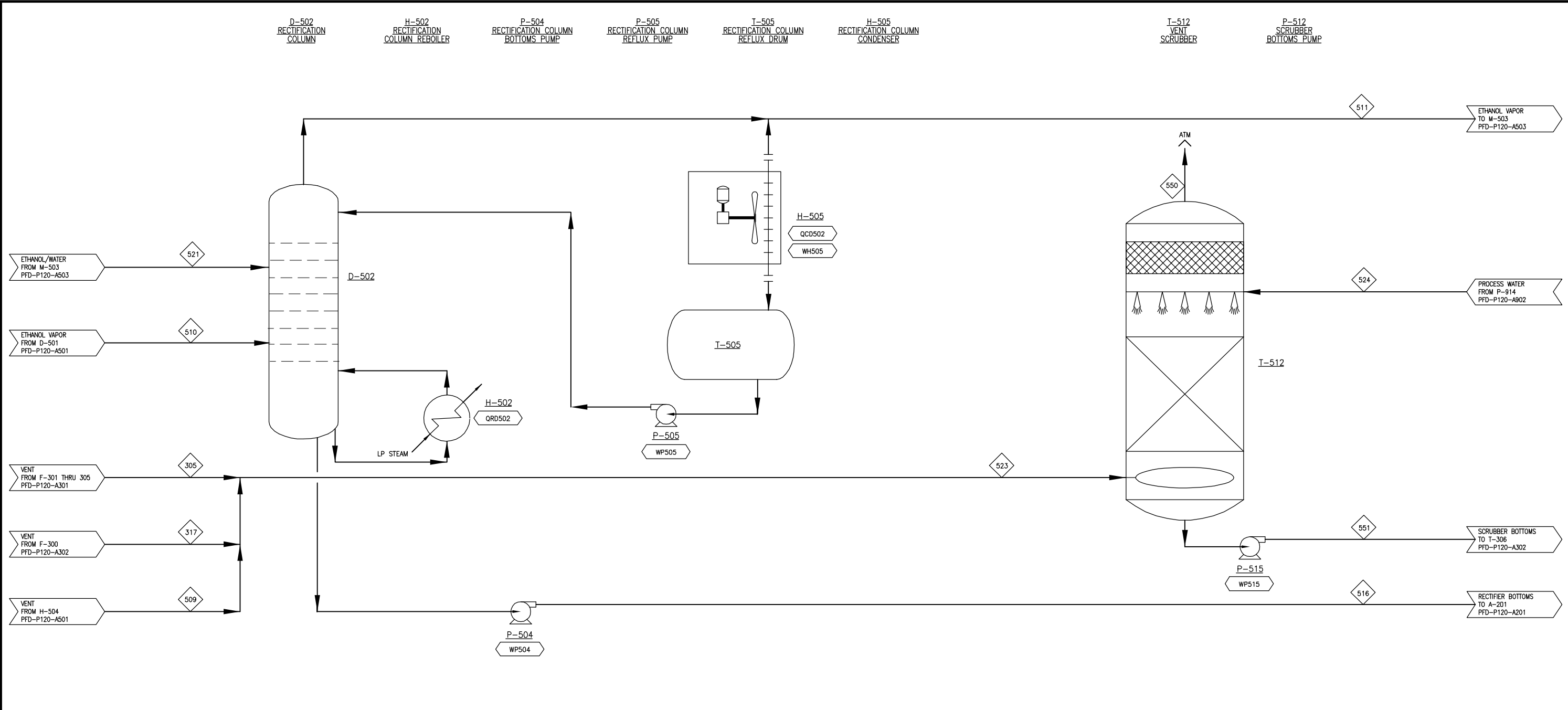

COMPONENT	UNITS	305	317	509	510	511	516	521	523	524	550	551
Total Flow	kg/hr	1,969	19,180	610	58,629	29,213	36,821	7,405	21,759	26,836	21,398	27,197
Insoluble Solids	%	0.0%	0.0%	0.0%	0.0%	0.0%	0.0%	0.0%	0.0%	0.0%	0.0%	0.0%
Soluble Solids	%	0.0%	0.0%	0.0%	0.0%	0.0%	0.0%	0.0%	0.0%	0.0%	0.0%	0.0%
Temperature	°C	32	32	60	117	91	114	71	33	33	34	34
Pressure	atm	1.0	1.0	2.0	2.1	1.6	6.1	1.7	1.0	5.0	0.9	4.3
Vapor Fraction		1.0	1.0	1.0	1.0	1.0	0.0	0.0	1.0	0.0	1.0	0.0
Ethanol	kg/hr	32	331	66	21,691	27,022	18	5,349	428	26,836	4	424
Water	kg/hr	38	369	23	36,737	2,164	36,629	2,056	429	26,836	522	26,743
Glucose (SS)	kg/hr	0	0	0	0	0	0	0	0	0	0	0
Xylose (SS)	kg/hr	0	0	0	0	0	0	0	0	0	0	0
Other sugars (SS)	kg/hr	0	0	0	0	0	0	0	0	0	0	0
Sugar Oligomers (SS)	kg/hr	0	0	0	0	0	0	0	0	0	0	0
Organic Soluble Solids (SS)	kg/hr	0	0	0	1	0	1	0	0	0	0	0
Inorganic Soluble Solids (SS)	kg/hr	0	0	0	0	0	0	0	0	0	0	0
Ammonia	kg/hr	0	0	0	0	0	0	0	0	0	0	0
Acetic Acid	kg/hr	0	0	0	0	0	0	0	0	0	0	0
Sulfuric Acid	kg/hr	0	0	0	0	0	0	0	0	0	0	0
Furfurals	kg/hr	0	2	0	172	0	172	3	0	0	0	3
Other Organics	kg/hr	0	0	0	0	0	0	0	0	0	0	0
Carbon Dioxide	kg/hr	1,882	18,323	522	27	27	0	0	20,727	0	20,699	28
Methane	kg/hr	0	0	0	0	0	0	0	0	0	0	0
O2	kg/hr	17	155	0	0	0	0	0	172	0	172	0
N2	kg/hr	0	0	0	0	0	0	0	0	0	0	0
CO/SOx/NOx/H2S	kg/hr	0	0	0	0	0	0	0	0	0	0	0
Cellulose (IS)	kg/hr	0	0	0	0	0	0	0	0	0	0	0
Xylan (IS)	kg/hr	0	0	0	0	0	0	0	0	0	0	0
Other Struct. Carbohydr. (IS)	kg/hr	0	0	0	0	0	0	0	0	0	0	0
Acetate (IS)	kg/hr	0	0	0	0	0	0	0	0	0	0	0
Lignin (IS)	kg/hr	0	0	0	0	0	0	0	0	0	0	0
Protein (IS)	kg/hr	0	0	0	0	0	0	0	0	0	0	0
Cell Mass (IS)	kg/hr	0	0	0	0	0	0	0	0	0	0	0
Other Insoluble Solids (IS)	kg/hr	0	0	0	0	0	0	0	0	0	0	0
Carbon Mole Flow	kmol/hr	44	431	15	951	1,174	10	232	490	0	471	19
COD	kg/hr	67	693	137	45,489	56,309	327	11,147	897	0	9	888
LHV @ 25°C	Gcal/hr	-0.2	-2.1	-0.4	-137.3	-167.8	16.9	-33.3	-2.7	15.4	-0.1	12.6

Heat Stream	Gcal/hr	Work Stream	kW	Gcal/hr
QCD502	23.180	WH505	223	0.192
QRD502	-5.654	WP504	8	0.007
		WP505	13	0.011
		WP515	5	0.004



**NREL**  
NATIONAL RENEWABLE ENERGY LABORATORY

**Harris Group Inc.**  
Engineering for Optimum Performance®  
www.harrisgroup.com

Scale: NONE  
 PMgr: DJD  
 Appr:

Drawn: JMW  
 Check:

Engr: PWS/JCL  
 Check:

**NATIONAL RENEWABLE ENERGY LABORATORY  
GOLDEN, COLORADO**

**2011 BIOCHEMICAL DESIGN REPORT**

**PROCESS FLOW DIAGRAM  
SECTION A500  
RECTIFICATION DISTILLATION**

Rev.	Date	By	Description
D	4/27/11	HGI	UPDATED STREAM TABLES
C	4/21/11	HGI	ISSUED FOR 2011 DESIGN REPORT
B	4/6/11	HGI	ADDED STREAM TABLES
A	12/22/09	HGI	ISSUED FOR DESIGN REPORT

Project No.:	30083.00	Drawing:	<b>PFD-P120-A502</b>	Rev.:	<b>D</b>
--------------	----------	----------	----------------------	-------	----------

M-503  
MOLECULAR  
SIEVE PACKAGE

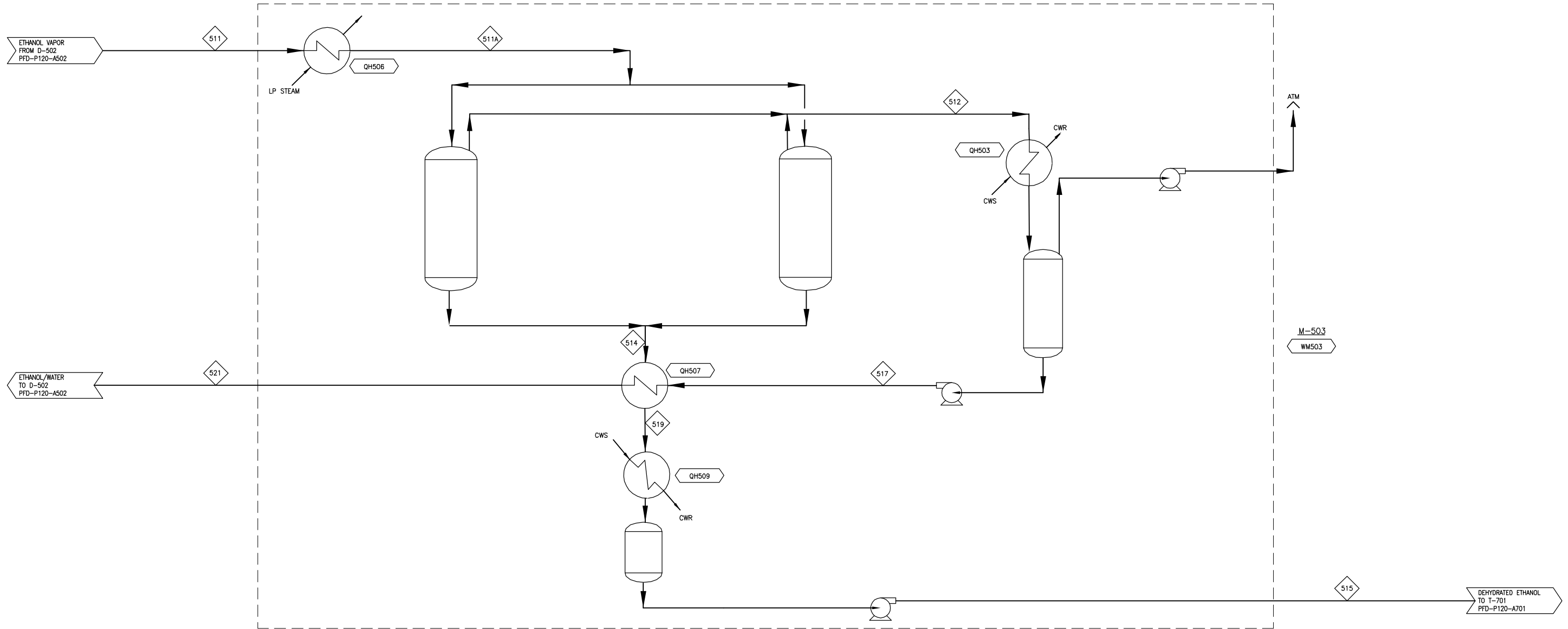

Ref. Date: 4/27/11  
 By: Section Designer  
 File Location: I:\1A - Process Solutions\10-30083 NREL - Wastewater\5000 PFDs\FINAL DRAWINGS FOR PUBLICATION\PFD-P120-A503.dwg

COMPONENT	UNITS	511	511A	512	514	515	517	519	521
Total Flow	kg/hr	29,213	29,213	7,405	21,808	21,808	7,405	21,808	7,405
Insoluble Solids	%	0.0%	0.0%	0.0%	0.0%	0.0%	0.0%	0.0%	0.0%
Soluble Solids	%	0.0%	0.0%	0.0%	0.0%	0.0%	0.0%	0.0%	0.0%
Temperature	°C	91	116	116	116	38	35	92	71
Pressure	atm	1.6	1.6	1.6	1.6	1.0	2.5	1.4	1.7
Vapor Fraction		1.0	1.0	1.0	1.0	0.0	0.0	1.0	0.0
Ethanol	kg/hr	27,022	27,022	5,349	21,673	21,673	5,349	21,673	5,349
Water	kg/hr	2,164	2,164	2,056	108	108	2,056	108	2,056
Glucose (SS)	kg/hr								
Xylose (SS)	kg/hr								
Other sugars (SS)	kg/hr								
Sugar Oligomers (SS)	kg/hr								
Organic Soluble Solids (SS)	kg/hr								
Inorganic Soluble Solids (SS)	kg/hr								
Ammonia	kg/hr	0	0		0	0		0	
Acetic Acid	kg/hr								
Sulfuric Acid	kg/hr								
Furfurals	kg/hr	0	0		0	0		0	
Other Organics	kg/hr								
Carbon Dioxide	kg/hr	27	27		27	27		27	
Methane	kg/hr								
O2	kg/hr	0	0		0	0		0	
N2	kg/hr	0	0		0	0		0	
CO/SOx/NOx/H2S	kg/hr	0	0		0	0		0	
Cellulose (IS)	kg/hr								
Xylan (IS)	kg/hr								
Other Struct. Carbohydr. (IS)	kg/hr								
Acetate (IS)	kg/hr								
Lignin (IS)	kg/hr								
Protein (IS)	kg/hr								
Cell Mass (IS)	kg/hr								
Other Insoluble Solids (IS)	kg/hr								
Carbon Mole Flow	kmol/hr	1,174	1,174	232	941	941	232	941	232
COD	kg/hr	56,309	56,309	11,147	45,162	45,162	11,147	45,162	11,147
LHV @ 25°C	Gcal/hr	-167.8	-168.1	-33.3	-134.7	-138.9	-33.1	-134.5	-33.3

Heat Stream	Gcal/hr	Work Stream	kW	Gcal/hr
QH503	2.565	WM503	151	0.130
QH506	-0.301			
QH507	0.214			
QH509	5.187			



NATIONAL RENEWABLE ENERGY LABORATORY



**Harris Group Inc.**  
Engineering for Optimum Performance®  
www.harrisgroup.com

Scale: NONE  
 PMgr: DJD  
 Appr:

Drawn: JMW  
 Check:

Engr: PWS/JCL  
 Check:

**NATIONAL RENEWABLE ENERGY LABORATORY**  
**GOLDEN, COLORADO**

**2011 BIOCHEMICAL DESIGN REPORT**

**PROCESS FLOW DIAGRAM**  
**SECTION A500**  
**ETHANOL DEHYDRATION**

Rev.	Date	By	Description
D	4/27/11	HGI	UPDATED STREAM TABLES
C	4/21/11	HGI	ISSUED FOR 2011 DESIGN REPORT
B	4/6/11	HGI	ADDED STREAM TABLES
A	12/22/09	HGI	ISSUED FOR DESIGN REPORT

Project No.: 30083.00  
 Drawing: PFD-P120-A503  
 Rev: D

Ref: Date: 4/27/11 By: Section: Design/Title  
 I:\1A - Process Solutions\10-30083\_NREL - Wastewater\5000\_PFDs\FINAL DRAWINGS FOR PUBLICATION\FD-P120-A505.dwg

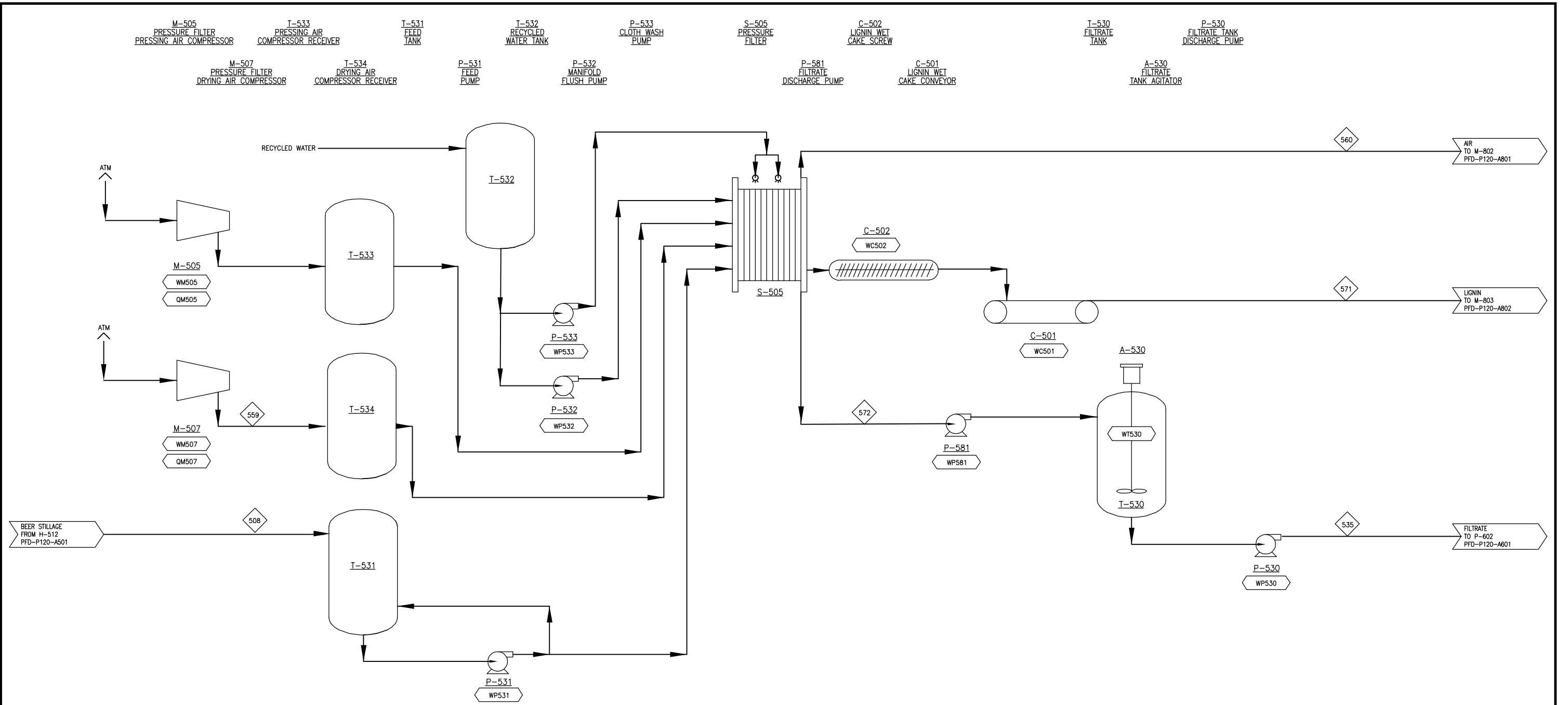

COMPONENT	UNITS	508	535	559	560	571	572
Total Flow	kg/hr	391,501	355,024	12,105	12,044	36,538	355,024
Insoluble Solids	%	5.9%	0.1%	0.0%	0.0%	62.3%	0.1%
Soluble Solids	%	6.2%	6.6%	0.0%	0.0%	2.5%	6.6%
Temperature	°C	47	47	80	55	55	47
Pressure	atm	6.3	3.9	6.9	6.9	6.9	1.0
Vapor Fraction		0.0	0.0	1.0	1.0	0.0	0.0
Ethanol	kg/hr	184	177		1	6	177
Water	kg/hr	341,765	329,030	237	175	12,797	329,030
Glucose (SS)	kg/hr	521	502		0	19	502
Xylose (SS)	kg/hr	1,062	1,022		0	40	1,022
Other sugars (SS)	kg/hr	2,175	2,094		0	81	2,094
Sugar Oligomers (SS)	kg/hr	1,612	1,552		0	60	1,552
Organic Soluble Solids (SS)	kg/hr	16,420	15,808		0	612	15,808
Inorganic Soluble Solids (SS)	kg/hr	2,610	2,513		97	2,513	
Ammonia	kg/hr	0	0		0	0	0
Acetic Acid	kg/hr						
Sulfuric Acid	kg/hr						
Furfurals	kg/hr	533	513		1	19	513
Other Organics	kg/hr	1,400	1,348		0	52	1,348
Carbon Dioxide	kg/hr						
Methane	kg/hr						
O2	kg/hr	0	0	2,764	2,764	1	0
N2	kg/hr	0	0	9,104	9,103	1	0
CO/SOx/NOx/H2S	kg/hr	0	0				0
Cellulose (IS)	kg/hr	1,255	25			1,230	25
Xylan (IS)	kg/hr	423	8			415	8
Other Struct. Carbohydr. (IS)	kg/hr	96	2			94	2
Acetate (IS)	kg/hr						
Lignin (IS)	kg/hr	12,475	250			12,226	250
Protein (IS)	kg/hr	3,445	69			3,376	69
Cell Mass (IS)	kg/hr	944	19			925	19
Other Insoluble Solids (IS)	kg/hr	4,581	92			4,489	92
Carbon Mole Flow	kmol/hr	1,738	801		0	937	801
COD	kg/hr	57,393	25,900		4	31,489	25,900
LHV @ 25°C	Gcal/hr	3.8	100.8	-0.2	-0.1	-97.3	100.9

Heat Stream	Gcal/hr	Work Stream	kW	Gcal/hr
QM505	0.093	WC501	7	0.006
QM507	0.733	WC502	11	0.009
		WM505	112	0.096
		WM507	1043	0.897
		WP530	37	0.032
		WP531	76	0.066
		WP532	7	0.006
		WP533	11	0.010
		WP581	37	0.032
		WT530	6	0.005

**Harris Group Inc.**  
Engineering for Optimum Performance®  
www.harrisgroup.com

Scale: NONE  
PMgr: DJD  
Appr:

Drawn: JMW  
Check:

Engr: PWS/JCL  
Check:

**NATIONAL RENEWABLE ENERGY LABORATORY**  
GOLDEN, COLORADO

**2011 BIOCHEMICAL DESIGN REPORT**

**PROCESS FLOW DIAGRAM**  
SECTION A500  
LIGNIN SEPARATION

Rev.	Date	By	Description
E	4/27/11	HGI	UPDATED STREAM TABLES
D	4/21/11	HGI	ISSUED FOR 2011 DESIGN REPORT
C	4/6/11	HGI	ADDED STREAM TABLES
B	3/21/11	HGI	REVISED BASED ON NEW WWT DESIGN
A	12/22/09	HGI	ISSUED FOR DESIGN REPORT

Project No.: 30083.00

Drawing: **PFD-P120-A505**

Rev:



I:\1A - Process Solutions\10-30083 NREL - Wastewater\5000 PFDs\FINAL DRAWINGS FOR PUBLICATION\FD-P120-A601.dwg  
 Section: Details  
 4/27/11

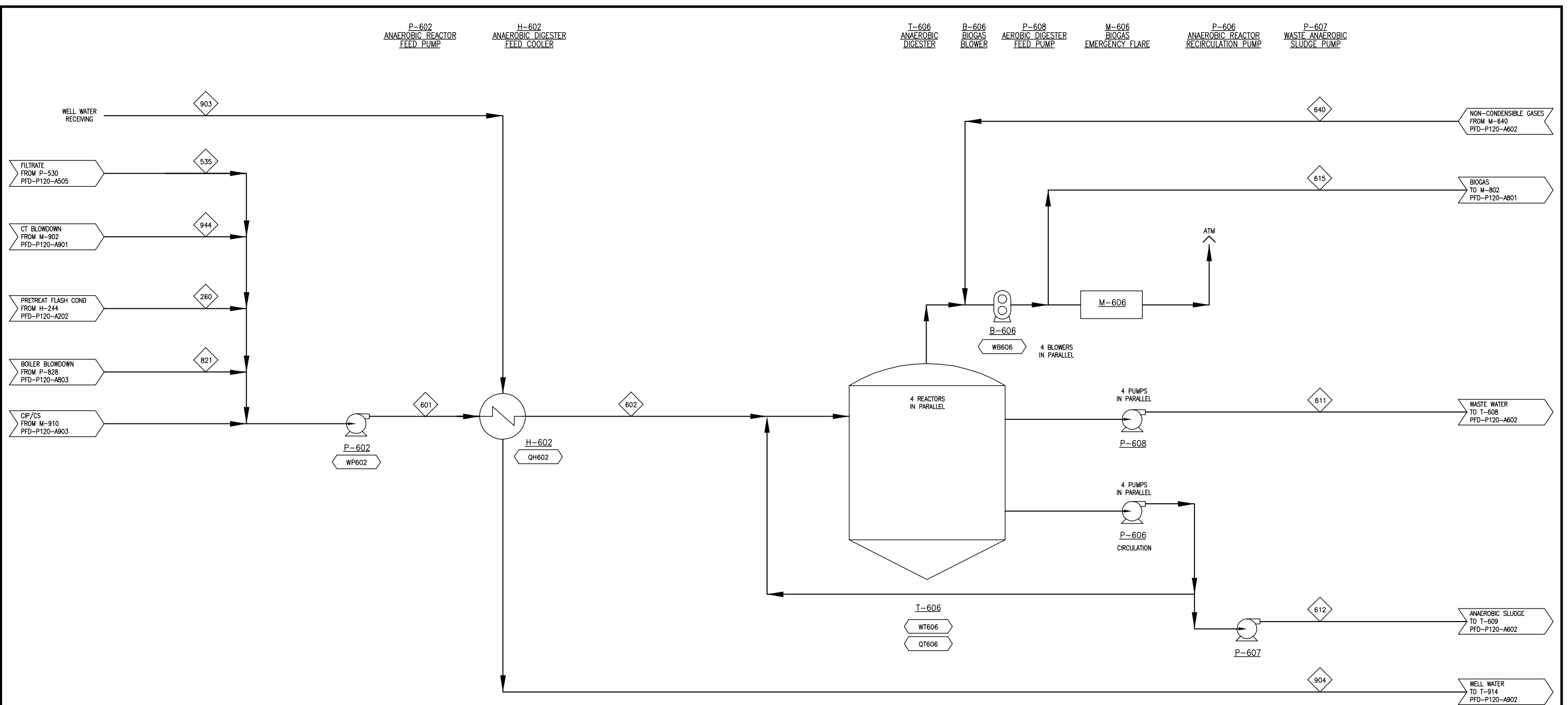

COMPONENT	UNITS	260	535	601	602	611	612	615	640	821	903	904	944
Total Flow	kg/hr	33,648	355,024	411,178	411,178	360,712	28,626	21,860	21	4,681	147,140	147,140	17,680
Insoluble Solids	%	0.0%	0.1%	0.1%	0.1%	0.1%	4.0%	0.0%	0.0%	0.0%	0.0%	0.0%	0.0%
Soluble Solids	%	0.0%	6.6%	5.7%	5.7%	0.8%	0.8%	0.0%	0.0%	0.0%	0.0%	0.0%	0.0%
Temperature	°C	100	47	52	35	35	35	38	86	100	13	59	28
Pressure	atm	1.0	3.9	1.3	1.3	1.0	1.0	1.0	1.0	5.4	4.0	2.0	5.1
Vapor Fraction		0.0	0.0	0.0	0.0	0.0	0.0	1.0	1.0	0.0	0.0	0.0	0.0
Ethanol	kg/hr	13	177	190	190	15	1	1	0				
Water	kg/hr	33,248	329,030	384,784	384,784	356,069	27,158	751	9	4,681	147,140	147,140	17,679
Glucose (SS)	kg/hr	0	502	502	502	42	3	0	0				
Xylose (SS)	kg/hr	0	1,022	1,022	1,022	85	7	0	0				
Other sugars (SS)	kg/hr	0	2,094	2,094	2,094	175	13	0	0				
Sugar Oligomers (SS)	kg/hr	0	1,552	1,552	1,552	130	10	0	0				
Organic Soluble Solids (SS)	kg/hr	0	15,808	15,808	15,808	2,387	182	0	0				
Inorganic Soluble Solids (SS)	kg/hr	0	2,513	2,513	2,513	110	8	0	0				
Ammonia	kg/hr	0	0	0	0	633	48	27	0				
Acetic Acid	kg/hr	58	58	58	58	5	0	0	0				
Sulfuric Acid	kg/hr	0	0	0	0	0	0	0	0				
Furfurals	kg/hr	329	513	842	842	70	5	1	0				
Other Organics	kg/hr	0	1,348	1,348	1,348	113	9	0	0				
Carbon Dioxide	kg/hr					181	14	14,269	3				
Methane	kg/hr					3	0	5,378	0				
O2	kg/hr	0	0	0	0	1	0	1,143	3				0
N2	kg/hr	0	0	0	0	0	0	5	5				0
CO/SOx/NOx/H2S	kg/hr	0	0	0	0	300	23	285	1				
Cellulose (IS)	kg/hr	25	25	25	25	6	19						
Xylan (IS)	kg/hr	8	8	8	8	2	6						
Other Struct. Carbohydr. (IS)	kg/hr	2	2	2	2	0	1						
Acetate (IS)	kg/hr												
Lignin (IS)	kg/hr	250	250	250	250	64	186						
Protein (IS)	kg/hr	69	69	69	69	18	51						
Cell Mass (IS)	kg/hr	19	19	19	19	280	813						
Other Insoluble Solids (IS)	kg/hr	92	92	92	92	23	68						
Carbon Mole Flow	kmol/hr	20	801	820	820	115	56	660	0				
COD	kg/hr	636	25,900	26,536	26,536	4,180	1,892	21,994	1				
LHV @ 25°C	Gcal/hr	14.8	100.8	128.3	134.6	187.8	8.9	-65.5	0.0	2.4	87.2	80.8	10.2

Heat Stream	Gcal/hr	Work Stream	kW	Gcal/hr
QH602	6.339	WB606	25	0.021
QT606	-1.734	WP602	4	0.004
		WT606	200	0.172



NATIONAL RENEWABLE ENERGY LABORATORY

**Harris Group Inc.**  
Engineering for Optimum Performance®  
www.harrisgroup.com

Scale: NONE  
 PMgr: DJD  
 Appr:

Drawn: JMW  
 Check:

Engr: PWS/JCL  
 Check:

**NATIONAL RENEWABLE ENERGY LABORATORY**  
**GOLDEN, COLORADO**

**2011 BIOCHEMICAL DESIGN REPORT**

**PROCESS FLOW DIAGRAM**  
**SECTION A600**  
**ANAEROBIC DIGESTION**

Project No.:	30083.00	Drawing:	PFD-P120-A601	Rev:	F
Rev.	Date	By	Description		



Section: D:\1A - Process Solutions\10-30083\_NREL - Wastewater\5000\_PFDs\FINAL DRAWINGS FOR PUBLICATION\FD-P120-A602.dwg  
 4/27/11

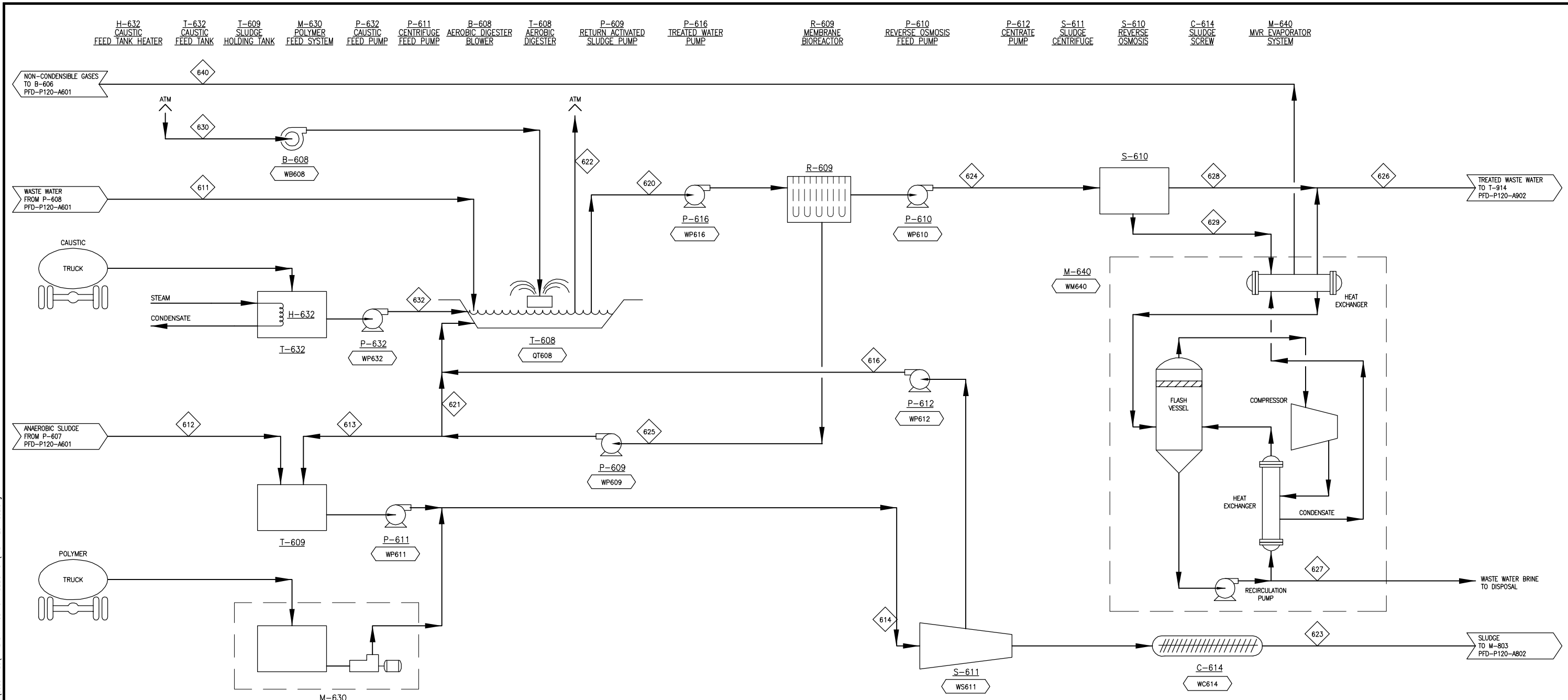

COMPONENT	UNITS	611	612	613	614	616	620	621	622	623	624	625	626	627	628	629	630	632	640
Total Flow	kg/hr	360,712	28,626	91,727	120,354	110,595	2,679,447	2,201,450	221,417	9,758	386,274	2,293,177	376,324	9,929	305,040	81,234	223,602	4,504	21
Insoluble Solids	%	0.1%	4.0%	1.0%	1.7%	0.1%	0.8%	1.0%	0.0%	20.0%	0.0%	1.0%	0.0%	0.0%	0.0%	0.0%	0.0%	0.0%	0.0%
Soluble Solids	%	0.8%	0.8%	1.3%	1.1%	1.2%	1.3%	1.3%	0.9%	1.3%	1.3%	1.3%	0.0%	49.5%	0.0%	6.0%	0.0%	50.0%	0.0%
Temperature	°C	35	35	25	29	29	25	25	25	29	25	25	27	100	25	25	25	20	86
Pressure	atm	1.0	1.0	2.0	2.0	1.0	1.0	2.0	1.0	2.0	4.4	1.0	1.0	1.0	1.0	1.0	1.0	2.0	1.0
Vapor Fraction		0.0	0.0	0.0	0.0	0.0	0.0	0.0	1.0	0.0	0.0	0.0	0.0	0.0	0.0	0.0	1.0	0.0	1.0
Ethanol	kg/hr	15	1	0	1	1	1	1	0	0	0	0	0	0	0	0	0	0	0
Water	kg/hr	356,069	27,158	89,647	116,805	109,098	2,622,465	2,151,522	4,350	7,708	381,300	2,241,169	376,324	4,967	305,040	76,260	4,379	2,252	9
Glucose (SS)	kg/hr	42	3	0	3	3	2	2	0	0	0	2	0	0	0	0	0	0	0
Xylose (SS)	kg/hr	85	7	0	7	6	4	3	0	0	1	3	0	1	0	0	0	0	0
Other sugars (SS)	kg/hr	175	13	0	14	13	8	6	0	1	1	7	0	1	1	0	0	0	0
Sugar Oligomers (SS)	kg/hr	130	10	0	10	9	7	6	0	1	1	6	0	1	1	0	0	0	0
Organic Soluble Solids (SS)	kg/hr	2,387	182	19	201	187	545	447	0	13	79	466	0	79	79	0	0	0	0
Inorganic Soluble Solids (SS)	kg/hr	110	8	1,135	1,143	1,068	33,206	27,243	0	75	4,828	28,378	4,828	4,828	4,828	0	2,252	0	0
Ammonia	kg/hr	633	48	1	49	46	19	16	1	3	3	16	0	3	3	0	0	0	0
Acetic Acid	kg/hr	5	0	0	0	0	0	0	0	0	0	0	0	0	0	0	0	0	0
Sulfuric Acid	kg/hr	0	0	0	0	0	0	0	0	0	0	0	0	0	0	0	0	0	0
Furfurals	kg/hr	70	5	0	5	5	3	3	0	0	0	3	0	0	0	0	0	0	0
Other Organics	kg/hr	113	9	0	9	8	8	6	0	1	1	7	0	1	1	0	0	0	0
Carbon Dioxide	kg/hr	181	14	2	15	14	44	36	3,857	1	6	38	0	3	3	0	6	0	3
Methane	kg/hr	3	0	0	0	0	0	0	3	0	0	0	0	0	0	0	0	0	0
O2	kg/hr	1	0	1	1	1	19	16	44,765	0	3	17	0	0	0	3	51,061	0	3
N2	kg/hr	0	0	1	1	1	37	31	168,157	0	5	32	0	0	5	168,162	0	0	5
CO/SOx/NOx/H2S	kg/hr	300	23	10	33	31	304	249	284	2	44	259	0	44	44	0	0	0	1
Cellulose (IS)	kg/hr	6	19	8	26	1	194	186	0	25	194	0	0	0	0	0	0	0	0
Xylan (IS)	kg/hr	2	6	3	9	0	65	63	0	8	65	0	0	0	0	0	0	0	0
Other Struct. Carbohydr. (IS)	kg/hr	0	1	1	2	0	15	14	0	2	15	0	0	0	0	0	0	0	0
Acetate (IS)	kg/hr																		
Lignin (IS)	kg/hr	64	186	77	263	13	1,925	1,848	0	250	1,925	0	0	0	0	0	0	0	0
Protein (IS)	kg/hr	18	51	4	55	3	90	86	0	52	90	0	0	0	0	0	0	0	0
Cell Mass (IS)	kg/hr	280	813	791	1,604	80	19,778	18,987	0	1,523	19,778	0	0	0	0	0	0	0	0
Other Insoluble Solids (IS)	kg/hr	23	68	28	96	5	707	679	0	92	707	0	0	0	0	0	0	0	0
Carbon Mole Flow	kmol/hr	115	56	40	95	12	995	952	88	83	4	991	0	4	4	0	0	0	0
COD	kg/hr	4,180	1,892	1,347	3,239	448	33,869	32,322	543	2,791	200	33,669	199	199	200	0	0	0	1
LHV @ 25°C	Gcal/hr	187.8	8.9	48.9	57.6	62.8	1451.4	1174.7	-1.1	-5.2	227.5	1223.7	218.1	8.2	177.3	50.2	0.0	3.3	0.0

Heat Stream	Gcal/hr	Work Stream	kW	Gcal/hr
QT608	25.640	WB608	4299	3.696
		WC614	1	0.000
		WM640	2171	1.867
		WP609	76	0.065
		WP610	301	0.259
		WP611	5	0.004
		WP612	4	0.004
		WP616	47	0.040
		WP632	0	0.000
		WS611	235	0.202



NATIONAL RENEWABLE ENERGY LABORATORY

**Harris Group Inc.**  
Engineering for Optimum Performance®  
www.harrisgroup.com

Scale: NONE  
 PMgr: DJD  
 Appr:

Drawn: JMW  
 Check:

Engr: PWS/JCL  
 Check:

**NATIONAL RENEWABLE ENERGY LABORATORY**  
GOLDEN, COLORADO

**2011 BIOCHEMICAL DESIGN REPORT**

**PROCESS FLOW DIAGRAM**  
SECTION A600  
**AEROBIC DIGESTION**

Project No.: 30083.00      Drawing: PFD-P120-A602      Rev: F

Rev.	Date	By	Description
F	4/27/11	HGI	UPDATED STREAM TABLES
E	4/21/11	HGI	ISSUED FOR 2011 DESIGN REPORT
D	4/6/11	HGI	ADDED STREAM TABLES
C	3/22/11	HGI	ADDED FEED/EFFLUENT HX TO MVR SYSTEM
B	3/21/11	HGI	ADDED MVR EVAP SYSTEM, CAUSTIC & POLYMER FEED SYSTEMS
A	12/22/09	HGI	ISSUED FOR DESIGN REPORT

File Location: \\A:\Process Solutions\10-30083\NREL - Wastewater\5000 PFDs\FINAL DRAWINGS FOR PUBLICATION\FPD-P120-A701.dwg  
 Br. Section: Dns/elle  
 Pld. Date: 4/27/11

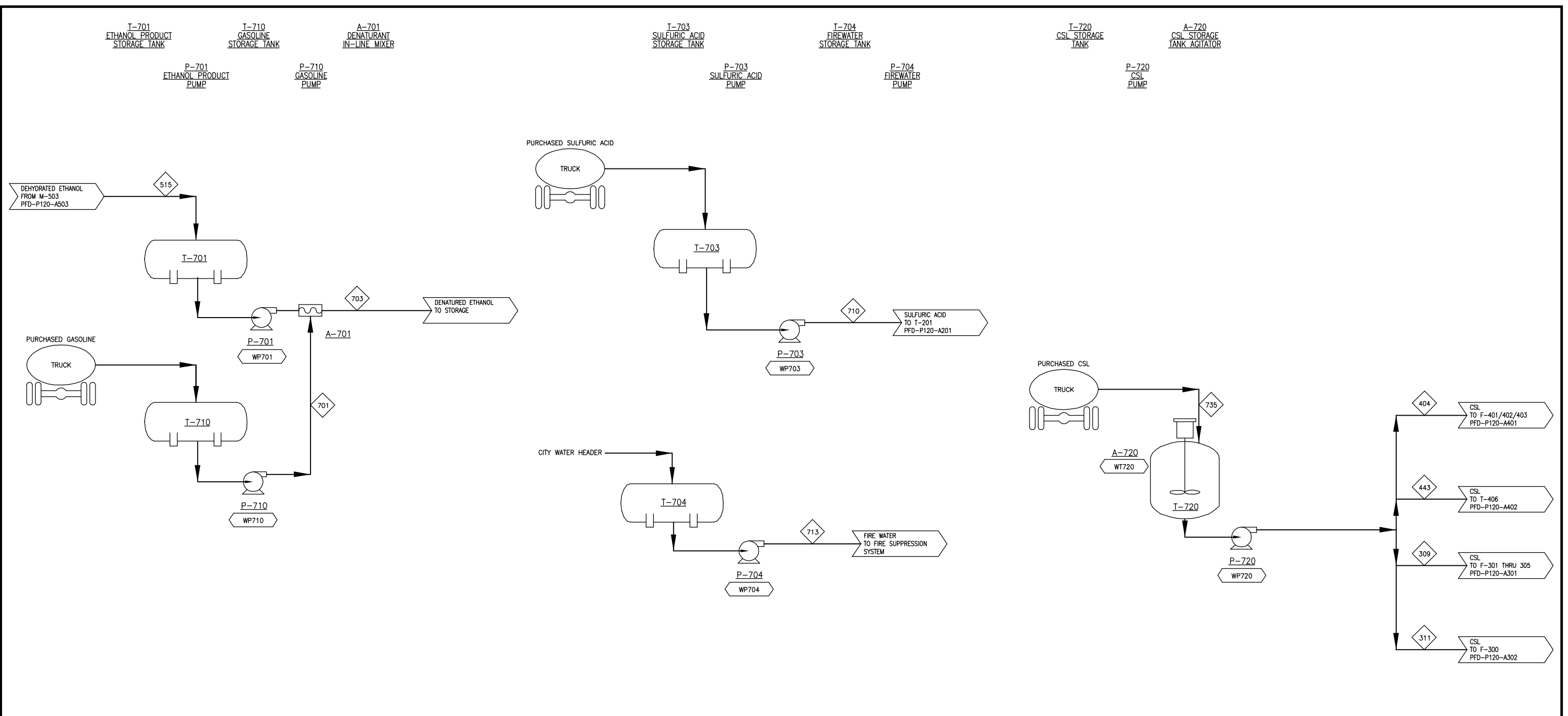

COMPONENT	UNITS	309	311	404	443	515	701	703	710	713	735
Total Flow	kg/hr	211	948	8	157	21,808	465	22,273	1,981	8,021	1,323
Insoluble Solids	%	25.0%	25.0%	25.0%	25.0%	0.0%	0.0%	0.0%	0.0%	0.0%	25.0%
Soluble Solids	%	24.8%	24.7%	24.7%	24.7%	0.0%	0.0%	0.0%	0.0%	0.0%	24.7%
Temperature	°C	20	20	20	20	38	21	20	21	20	20
Pressure	atm	5.4	5.4	1.0	1.0	1.0	6.9	1.0	5.4	1.0	1.0
Vapor Fraction		0.0	0.0	0.0	0.0	0.0	0.0	0.0	0.0	0.0	0.0
Ethanol	kg/hr					21,673		21,673			
Water	kg/hr	106	476	4	79	108		108	139	8,021	665
Glucose (SS)	kg/hr										
Xylose (SS)	kg/hr										
Other sugars (SS)	kg/hr										
Sugar Oligomers (SS)	kg/hr										
Organic Soluble Solids (SS)	kg/hr	52	235	2	39						327
Inorganic Soluble Solids (SS)	kg/hr										
Ammonia	kg/hr					0		0			
Acetic Acid	kg/hr								1,842		
Sulfuric Acid	kg/hr										
Furfurals	kg/hr					0		0			
Other Organics	kg/hr						465	465			
Carbon Dioxide	kg/hr					27		27			
Methane	kg/hr										
O2	kg/hr					0		0			
N2	kg/hr					0		0			
CO/SOX/NOX/H2S	kg/hr					0		0			
Cellulose (IS)	kg/hr										
Xylan (IS)	kg/hr										
Other Struct. Carbohydr. (IS)	kg/hr										
Acetate (IS)	kg/hr										
Lignin (IS)	kg/hr										
Protein (IS)	kg/hr	53	237	2	39						331
Cell Mass (IS)	kg/hr										
Other Insoluble Solids (IS)	kg/hr										
Carbon Mole Flow	kmol/hr	4	18	0	3	941	32	974			25
COD	kg/hr	132	592	5	98	45,162	1,633	46,795			826
LHV @ 25°C	Gcal/hr	-0.4	-1.7	0.0	-0.3	-138.9	-4.9	-143.6	1.2	4.7	-2.4

Work Stream	kW	Gcal/hr
WP701	5	0.004
WP703	1	0.000
WP704	0	0.000
WP710	0	0.000
WP720	0	0.000
WT720	2	0.002



NATIONAL RENEWABLE ENERGY LABORATORY



Harris Group Inc.  
Engineering for Optimum Performance®  
www.harrisgroup.com

Scale: NONE  
PMgr: DJD  
Appr:

Drawn: JMW  
Check:

Engr: PWS/JCL  
Check:

**NATIONAL RENEWABLE ENERGY LABORATORY**  
GOLDEN, COLORADO

**2011 BIOCHEMICAL DESIGN REPORT**

**PROCESS FLOW DIAGRAM**  
SECTION A700  
STORAGE

Project No.: 30083.00

Drawing: PFD-P120-A701

Rev: 

Rev.	Date	By	Description
D	4/27/11	HGI	UPDATED STREAM TABLES
C	4/21/11	HGI	ISSUED FOR 2011 DESIGN REPORT
B	4/6/11	HGI	ADDED STREAM TABLES
A	12/22/09	HGI	ISSUED FOR DESIGN REPORT

T-755  
DAP BULK BAG  
HOLDER

C-755  
DAP BULK BAG  
UNLOADER

T-760  
DAP MAKE-UP  
TANK

A-760  
DAP MAKE-UP  
TANK AGITATOR

T-706  
AMMONIA  
STORAGE TANK

P-760  
DAP  
PUMP

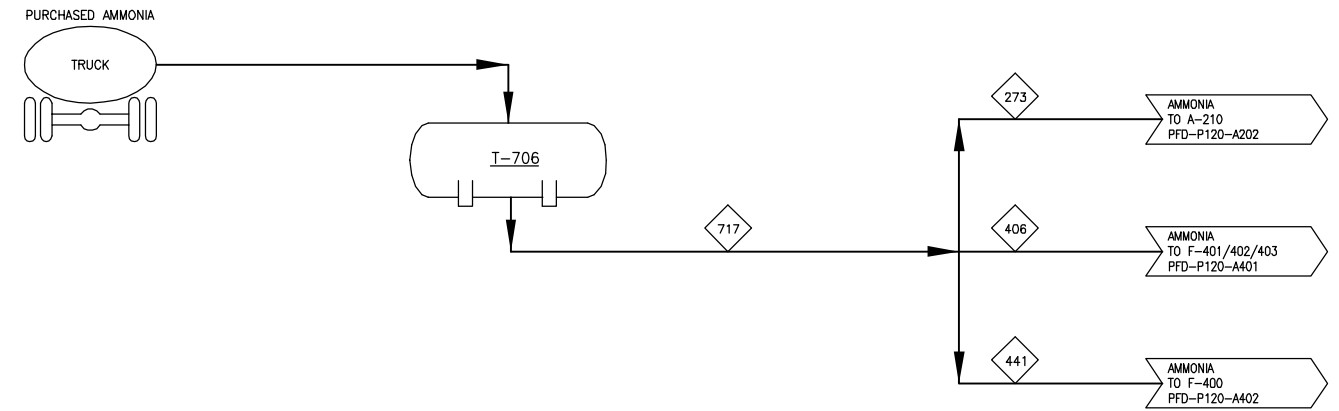
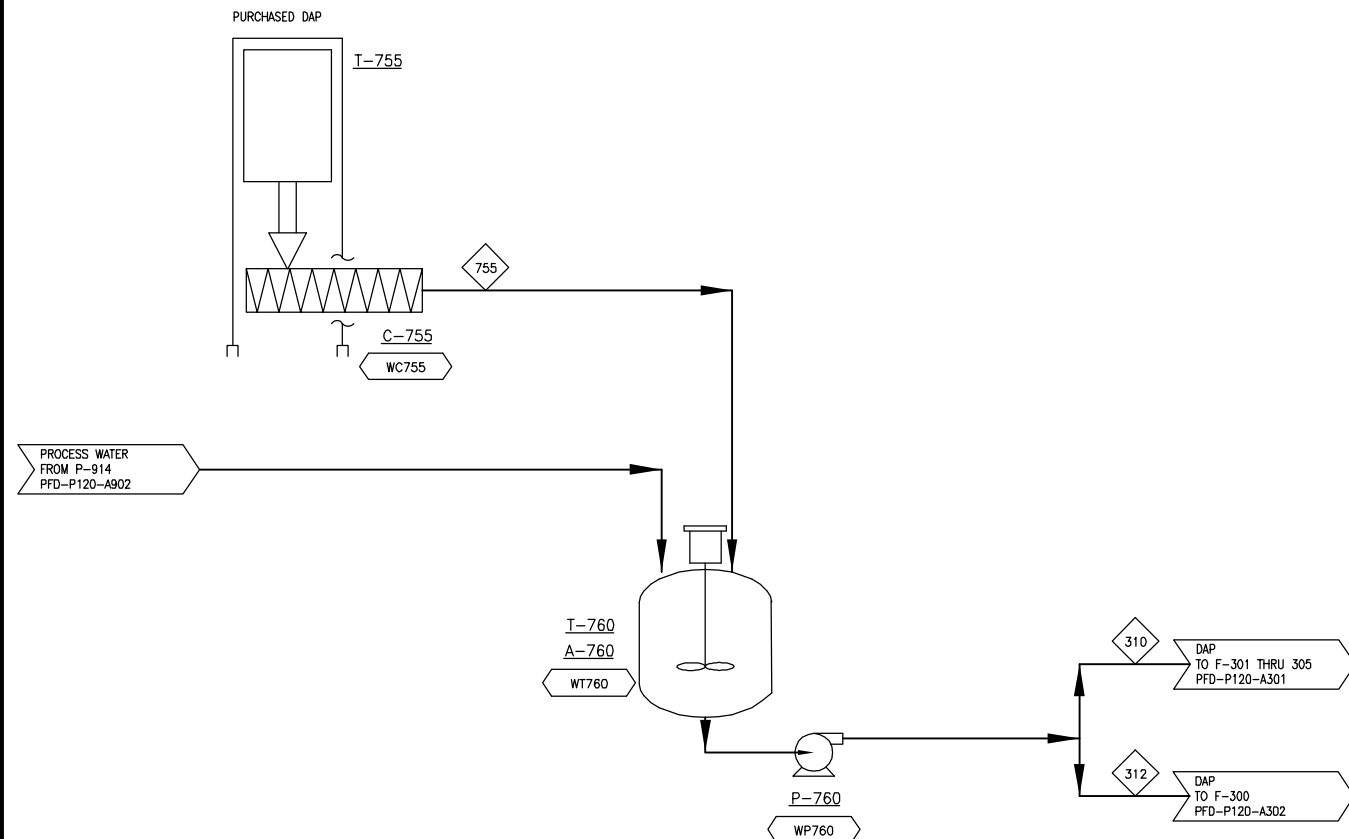

File Location: I:\1A - Process Solutions\10-30083 NREL - Wastewater\5000 PFDs\FINAL DRAWINGS FOR PUBLICATION\PFD-P120-A702.dwg  
 Pr. Section: Dns@le  
 Pld. Date: 4/27/11

COMPONENT	UNITS	273	310	312	406	441	717	755
Total Flow	kg/hr	1,051	26	116	6	109	1,166	142
Insoluble Solids	%	0.0%	0.0%	0.0%	0.0%	0.0%	0.0%	0.0%
Soluble Solids	%	0.0%	100.0%	100.0%	0.0%	0.0%	0.0%	100.0%
Temperature	°C	20	20	20	28	28	20	20
Pressure	atm	17.0	1.0	1.0	9.0	9.0	17.0	1.0
Vapor Fraction		0.0	0.0	0.0	1.0	1.0	0.0	0.0
Ethanol	kg/hr							
Water	kg/hr							
Glucose (SS)	kg/hr							
Xylose (SS)	kg/hr							
Other sugars (SS)	kg/hr							
Sugar Oligomers (SS)	kg/hr							
Organic Soluble Solids (SS)	kg/hr							
Inorganic Soluble Solids (SS)	kg/hr		26	116				142
Ammonia	kg/hr	1,051			6	109	1,166	
Acetic Acid	kg/hr							
Sulfuric Acid	kg/hr							
Furfurals	kg/hr							
Other Organics	kg/hr							
Carbon Dioxide	kg/hr							
Methane	kg/hr							
O2	kg/hr							
N2	kg/hr							
CO/SOx/NOx/H2S	kg/hr							
Cellulose (IS)	kg/hr							
Xylan (IS)	kg/hr							
Other Struct. Carbohydr. (IS)	kg/hr							
Acetate (IS)	kg/hr							
Lignin (IS)	kg/hr							
Protein (IS)	kg/hr							
Cell Mass (IS)	kg/hr							
Other Insoluble Solids (IS)	kg/hr							
Carbon Mole Flow	kmol/hr							
COD	kg/hr							
LHV @ 25°C	Gcal/hr	-4.4	0.0	0.0	0.0	-0.5	-4.8	0.0

Work Stream	kW	Gcal/hr
WC755	0	0.000
WP760	0	0.000
WT760	3	0.002



NATIONAL RENEWABLE ENERGY LABORATORY

**Harris Group Inc.**  
Engineering for Optimum Performance®  
www.harrisgroup.com

Scale: NONE  
 PMgr: DJD      Drawn: JMW      Engr: PWS/JCL  
 Appr:              Check:              Check:

**NATIONAL RENEWABLE ENERGY LABORATORY**  
**GOLDEN, COLORADO**

**2011 BIOCHEMICAL DESIGN REPORT**

**PROCESS FLOW DIAGRAM**  
**SECTION A700**  
**STORAGE**

Rev.	Date	By	Description
D	4/27/11	HGI	UPDATED STREAM TABLES
C	4/21/11	HGI	ISSUED FOR 2011 DESIGN REPORT
B	4/6/11	HGI	ADDED STREAM TABLES
A	12/22/09	HGI	ISSUED FOR DESIGN REPORT

Project No.: 30083.00      Drawing: **PFD-P120-A702**      Rev: D

Ref: Date: 4/27/11 Br: Section: D:\11A - Process Solutions\10-30083 NREL - Wastewater\5000 PFDs\FINAL DRAWINGS FOR PUBLICATION\PFD-P120-A801.dwg  
 File Location: I:\11A - Process Solutions\10-30083 NREL - Wastewater\5000 PFDs\FINAL DRAWINGS FOR PUBLICATION\PFD-P120-A801.dwg

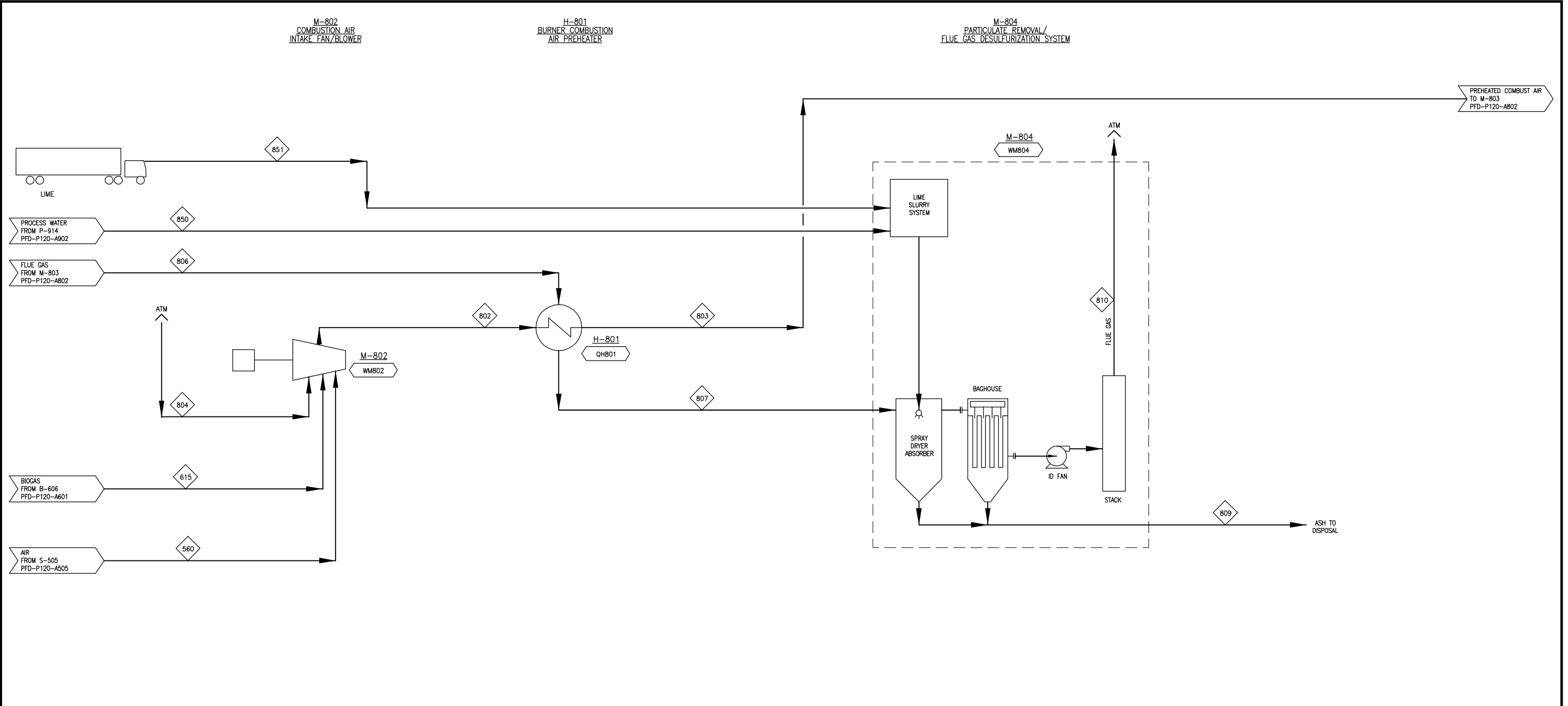

COMPONENT	UNITS	560	615	802	803	804	806	807	809	810	850	851
Total Flow	kg/hr	12,044	21,860	318,399	318,399	284,495	364,696	364,696	5,725	363,445	3,579	895
Insoluble Solids	%	0.0%	0.0%	0.0%	0.0%	0.0%	1.2%	1.2%	100.0%	0.0%	0.0%	100.0%
Soluble Solids	%	0.0%	0.0%	0.0%	0.0%	0.0%	0.0%	0.0%	0.0%	0.0%	0.0%	0.0%
Temperature	°C	55	38	29	192	25	278	149	0	145	33	25
Pressure	atm	6.9	1.0	1.0	1.0	1.0	1.0	1.0	1.0	1.0	5.0	1.0
Vapor Fraction		1.0	1.0	1.0	1.0	1.0	1.0	1.0	0.0	1.0	0.0	0.0
Ethanol	kg/hr	1	1	2	2					54,451	3,579	
Water	kg/hr	175	751	6,498	6,498	5,572	50,698	50,698				
Glucose (SS)	kg/hr	0	0	0	0							
Xylose (SS)	kg/hr	0	0	0	0							
Other sugars (SS)	kg/hr	0	0	0	0							
Sugar Oligomers (SS)	kg/hr	0	0	0	0							
Organic Soluble Solids (SS)	kg/hr	0	0	0	0							
Inorganic Soluble Solids (SS)	kg/hr	0	0	0	0		80	80		80		
Ammonia	kg/hr	0	27	27	27		30	30		30		
Acetic Acid	kg/hr	0	0	0	0							
Sulfuric Acid	kg/hr	0	0	0	0		0	0		0		
Furfurals	kg/hr	1	1	2	2							
Other Organics	kg/hr	0	0	0	0							
Carbon Dioxide	kg/hr		14,269	14,269	14,269		73,396	73,396		73,396		
Methane	kg/hr		5,378	5,378	5,378							
O2	kg/hr	2,764	1,143	68,873	68,873	64,966	11,479	11,479		11,324		
N2	kg/hr	9,103	5	223,065	223,065	213,957	223,985	223,985		223,985		
CO/SOx/NOx/H2S	kg/hr		285	285	285		797	797		178		
Cellulose (IS)	kg/hr											
Xylan (IS)	kg/hr											
Other Struct. Carbohydr. (IS)	kg/hr											
Acetate (IS)	kg/hr											
Lignin (IS)	kg/hr											
Protein (IS)	kg/hr											
Cell Mass (IS)	kg/hr											
Other Insoluble Solids (IS)	kg/hr						4,230	4,230	5,725			895
Carbon Mole Flow	kmol/hr	0	660	660	660		1,680	1,680	10	1,670		
CO2	kg/hr	4	21,994	21,997	21,997		530	530	326	49		
LHV @ 25°C	Gcal/hr	-0.1	-65.5	-65.7	-78.8	0.0	-26.4	-13.3	0.1	-11.6	2.1	0.3

Heat Stream	Gcal/hr	Work Stream	kW	Gcal/hr
QH801	13.112	WCMBFAN	142	0.122
		WM804	596	0.512

Scale: NONE  
 PMgr: DJD  
 Appr:

Drawn: JMW  
 Check:

Engr: PWS/JCL  
 Check:

**NATIONAL RENEWABLE ENERGY LABORATORY**  
**GOLDEN, COLORADO**

**2011 BIOCHEMICAL DESIGN REPORT**

**PROCESS FLOW DIAGRAM**  
**SECTION A800**  
**PARTICULATE REMOVAL/FGD**

Rev.	Date	By	Description
E	4/27/11	HGI	UPDATED STREAM TABLES
D	4/21/11	HGI	ISSUED FOR 2011 DESIGN REPORT
C	4/6/11	HGI	ADDED STREAM TABLES
B	3/21/11	HGI	REVISED FOR FGD SYSTEM
A	12/22/09	HGI	ISSUED FOR DESIGN REPORT

Project No.: 30083.00

Drawing: PFD-P120-A801

Rev:

Ref. Date: 4/27/11 Br. Section: Densite File Location: \\A:\A - Process Solutions\10-30083 NREL - Wastewater\5000 PFDs\FINAL DRAWINGS FOR PUBLICATION\FD-P120-A802.dwg

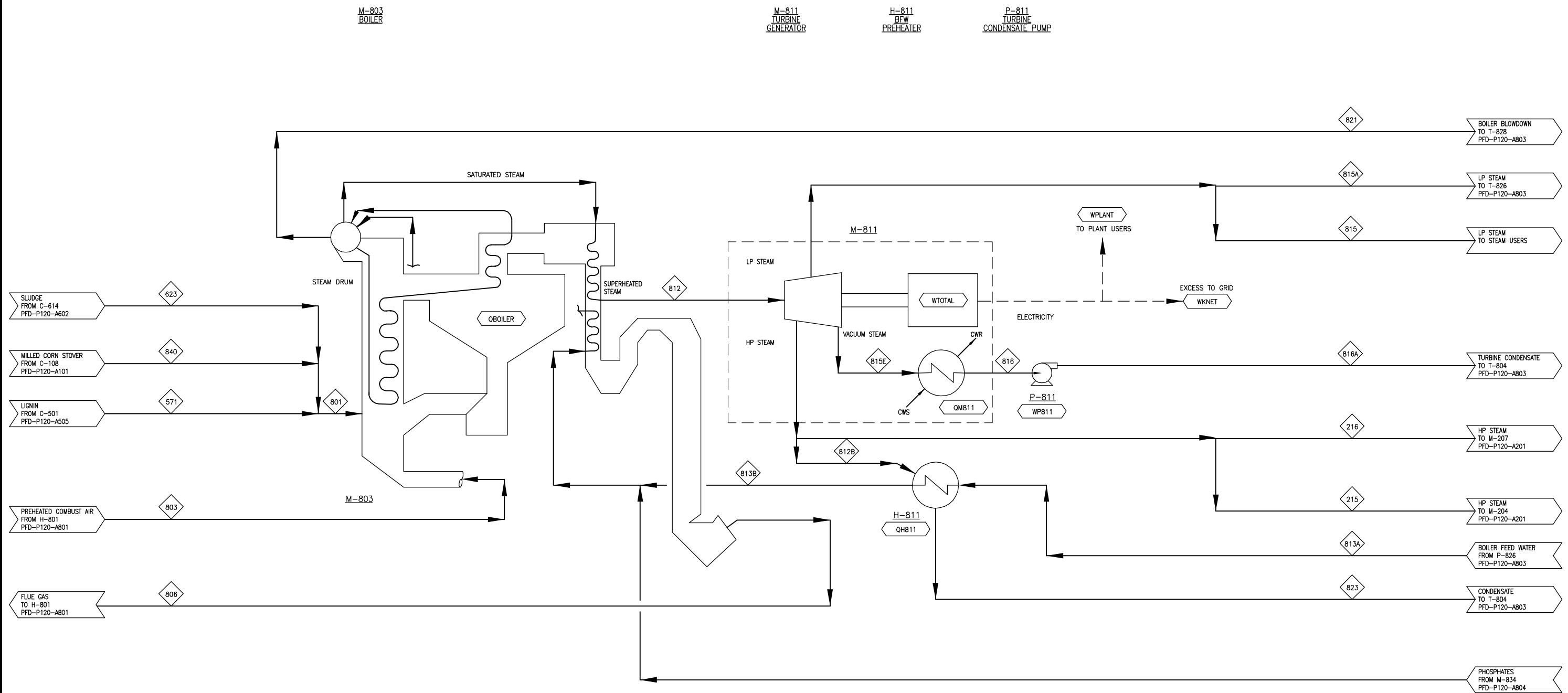

COMPONENT	UNITS	215	216	571	623	801	803	806	812	812B	813A	813B	815	815A	815E	816	816A	821	823	840
Total Flow	kg/hr	3,490	24,534	36,538	9,758	46,297	318,399	364,696	234,784	30,132	242,044	242,045	75,071	104	101,453	101,453	101,453	4,681	30,132	0
Insoluble Solids	%	0.0%	0.0%	62.3%	20.0%	53.4%	0.0%	1.2%	0.0%	0.0%	0.0%	0.0%	0.0%	0.0%	0.0%	0.0%	0.0%	0.0%	0.0%	0.0%
Soluble Solids	%	0.0%	0.0%	2.5%	0.9%	2.2%	0.0%	0.0%	0.0%	0.0%	0.0%	0.0%	0.0%	0.0%	0.0%	0.0%	0.0%	0.0%	0.0%	0.0%
Temperature	°C	266	266	55	29	47	192	278	454	266	114	176	233	233	46	46	46	100	192	25
Pressure	atm	13.0	13.0	6.9	2.0	1.0	1.0	1.0	59.9	13.0	62.2	62.2	9.5	9.5	0.1	0.1	5.0	5.4	13.0	1.0
Vapor Fraction		1.0	1.0	0.0	0.0	0.0	1.0	1.0	1.0	1.0	0.0	0.0	1.0	1.0	0.9	0.0	0.0	0.0	0.0	1.0
Ethanol	kg/hr			6	0	6	2													
Water	kg/hr	3,490	24,534	12,797	7,708	20,505	6,498	50,698	234,784	30,132	242,044	242,045	75,071	104	101,453	101,453	101,453	4,681	30,132	
Glucose (SS)	kg/hr			19	0	20	0													
Xylose (SS)	kg/hr			40	0	40	0													
Other sugars (SS)	kg/hr			81	1	82	0													
Sugar Oligomers (SS)	kg/hr			60	1	61	0													
Organic Soluble Solids (SS)	kg/hr			612	13	625	0													
Inorganic Soluble Solids (SS)	kg/hr			97	75	173	0	80												
Ammonia	kg/hr			0	3	3	27	30												
Acetic Acid	kg/hr			0	0	0	0	0												
Sulfuric Acid	kg/hr			0	0	0	0	0												
Furfurals	kg/hr			19	0	20	2													
Other Organics	kg/hr			52	1	53	0													
Carbon Dioxide	kg/hr			1	1	14,269	73,396													
Methane	kg/hr			0	0	5,378														0
O2	kg/hr			1	0	1	68,873	11,479												
N2	kg/hr			1	0	1	223,065	223,985												
CO/SOX/NOX/H2S	kg/hr				2	2	285	797												
Cellulose (IS)	kg/hr			1,230	25	1,255														
Xylan (IS)	kg/hr			415	8	423														
Other Struct. Carbohydr. (IS)	kg/hr			94	2	96														
Acetate (IS)	kg/hr																			
Lignin (IS)	kg/hr			12,226	250	12,475														
Protein (IS)	kg/hr			3,376	52	3,428														
Cell Mass (IS)	kg/hr			925	1,523	2,448														
Other Insoluble Solids (IS)	kg/hr			4,489	92	4,581		4,230												
Carbon Mole Flow	kmol/hr			937	83	1,021	660	1,680												0
COD	kg/hr			31,489	2,791	34,279	21,997	530												0
LHV @ 25°C	Gcal/hr	-0.3	-2.5	-97.3	-5.2	-102.4	-78.8	-26.4	-42.9	-3.0	119.4	103.9	-6.4	0.0	6.3	56.9	56.9	2.4	12.4	0.0



Heat Stream	Gcal/hr	Work Stream	kW	Gcal/hr
QBOILER	144.629	WKNET	-12797	-11.003
QH811	15.467	WP811	20	0.017
QM811	50.717	WPLANT	-28527	-24.529
		WTOTAL	-41324	-35.532

**Harris Group Inc.**  
 Engineering for Optimum Performance®  
 www.harrisgroup.com

Scale: NONE  
 PMgr: DJD  
 Appr:

Drawn: JMW  
 Check:

Engr: PWS/JCL  
 Check:

Project No.: 30083.00  
 Drawing: PFD-P120-A802  
 Rev: E

Rev.	Date	By	Description
E	4/27/11	HGI	UPDATED STREAM TABLES
D	4/21/11	HGI	ISSUED FOR 2011 DESIGN REPORT
C	4/6/11	HGI	ADDED STREAM TABLES
B	3/21/11	HGI	ADDED STREAM 216B
A	12/22/09	HGI	ISSUED FOR DESIGN REPORT

NATIONAL RENEWABLE ENERGY LABORATORY  
 GOLDEN, COLORADO

2011 BIOCHEMICAL DESIGN REPORT  
 PROCESS FLOW DIAGRAM  
 SECTION A800  
 COMBUSTOR AND TURBOGENERATOR

Ref. Date: 4/27/11  
 By: Section, Danville  
 File Location: I:\1A - Process Solutions\10-30083 NREL - Wastewater\5000 PFDs\FINAL DRAWINGS FOR PUBLICATION\FD-P120-A803.dwg

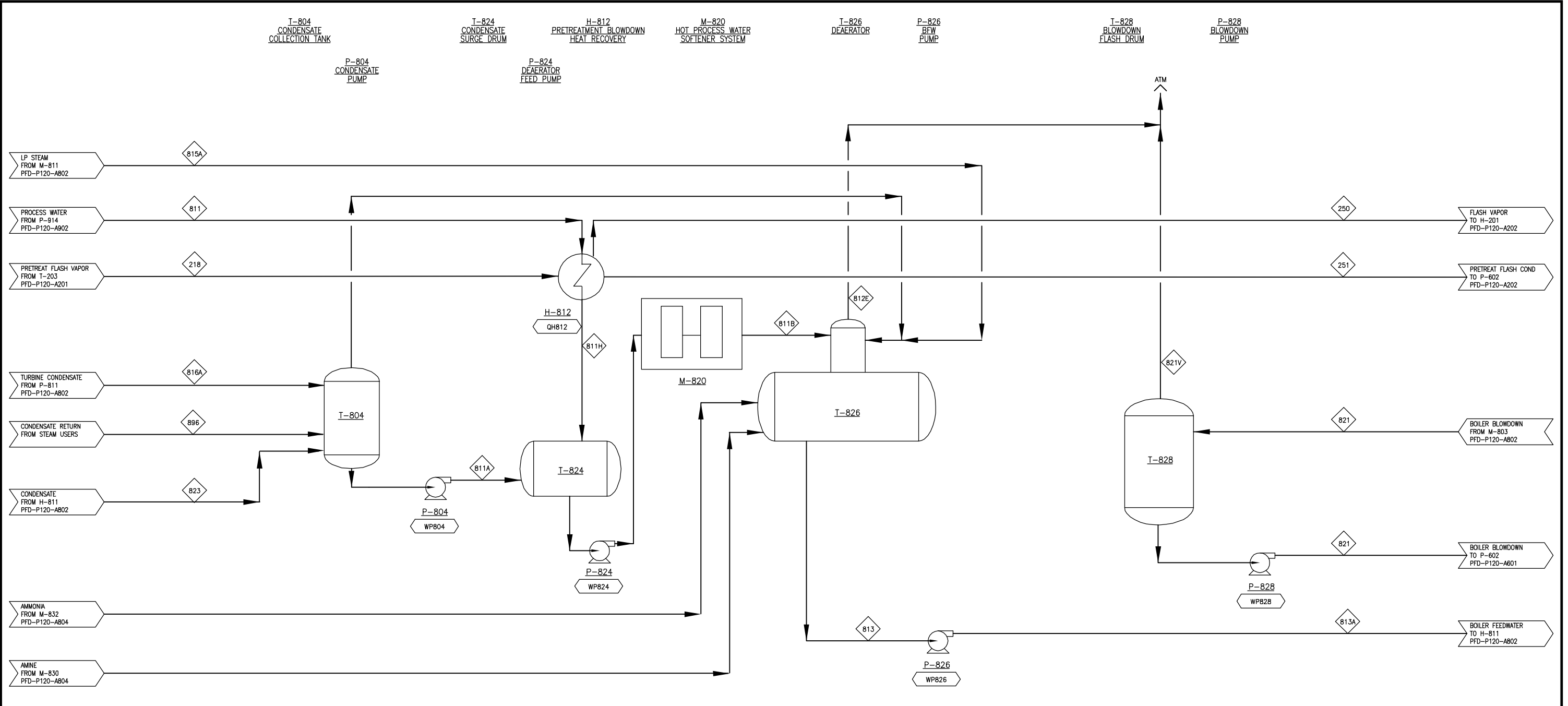

COMPONENT	UNITS	218	250	251	811	811A	811B	811H	812E	813	813A	815A	816A	821	821V	823	896
Total Flow	kg/hr	19,782	15,932	3,850	35,284	206,656	241,940	35,284	0	242,044	242,044	104	101,453	4,681	2,580	30,132	75,071
Insoluble Solids	%	0.0%	0.0%	0.0%	0.0%	0.0%	0.0%	0.0%	0.0%	0.0%	0.0%	0.0%	0.0%	0.0%	0.0%	0.0%	0.0%
Soluble Solids	%	0.0%	0.0%	0.0%	0.0%	0.0%	0.0%	0.0%	0.0%	0.0%	0.0%	0.0%	0.0%	0.0%	0.0%	0.0%	0.0%
Temperature	°C	130	100	100	33	114	111	95	0	113	114	233	46	100	100	192	171
Pressure	atm	2.6	1.0	1.0	5.4	5.2	4.4	5.4	1.5	1.5	62.2	9.5	5.0	5.4	1.0	13.0	8.0
Vapor Fraction		1.0	1.0	0.0	0.0	0.0	0.0	0.0	0.0	0.0	0.0	1.0	0.0	0.0	1.0	0.0	0.0
Ethanol	kg/hr	8	8	0													
Water	kg/hr	19,533	15,702	3,831	35,284	206,656	241,940	35,284		242,044	242,044	104	101,453	4,681	2,580	30,132	75,071
Glucose (SS)	kg/hr	0	0	0													
Xylose (SS)	kg/hr	0	0	0													
Other sugars (SS)	kg/hr	0	0	0													
Sugar Oligomers (SS)	kg/hr	0	0	0													
Organic Soluble Solids (SS)	kg/hr	0	0	0													
Inorganic Soluble Solids (SS)	kg/hr																
Ammonia	kg/hr	0	0	0													
Acetic Acid	kg/hr	36	25	11													
Sulfuric Acid	kg/hr	0	0	0													
Furfurals	kg/hr	205	197	8													
Other Organics	kg/hr	0	0	0													
Carbon Dioxide	kg/hr																
Methane	kg/hr																
O2	kg/hr																
N2	kg/hr																
CO/SOx/NOx/H2S	kg/hr																
Cellulose (IS)	kg/hr																
Xylan (IS)	kg/hr																
Other Struct. Carbohydr. (IS)	kg/hr																
Acetate (IS)	kg/hr																
Lignin (IS)	kg/hr																
Protein (IS)	kg/hr																
Cell Mass (IS)	kg/hr																
Other Insoluble Solids (IS)	kg/hr																
Carbon Mole Flow	kmol/hr	12	11	1													
COD	kg/hr	396	372	25													
LHV @ 25°C	Gcal/hr	-2.9	-1.7	1.9	20.2	101.8	119.9	18.1	0.0	119.5	119.4	0.0	56.9	2.4	-0.1	12.4	32.6

Heat Stream	Gcal/hr	Work Stream	kW	Gcal/hr
QH812	-2.185	WP804	8	0.007
		WP824	9	0.008
		WP826	559	0.481
		WP828	2	0.002



**NREL**  
NATIONAL RENEWABLE ENERGY LABORATORY



**Harris Group Inc.**  
Engineering for Optimum Performance®  
www.harrisgroup.com

Scale: NONE  
 PMgr: DJD  
 Appr:

Drawn: JMW  
 Check:

Engr: PWS/JCL  
 Check:

**NATIONAL RENEWABLE ENERGY LABORATORY**  
**GOLDEN, COLORADO**

**2011 BIOCHEMICAL DESIGN REPORT**

**PROCESS FLOW DIAGRAM**  
**SECTION A800**  
**BOILER FEED WATER PREPARATION**

Rev.	Date	By	Description
E	4/27/11	HGI	UPDATED STREAM TABLES
D	4/21/11	HGI	ISSUED FOR 2011 DESIGN REPORT
C	4/6/11	HGI	ADDED STREAM TABLES
B	3/21/11	HGI	GENERAL DRAFTING REVISIONS
A	12/22/09	HGI	ISSUED FOR DESIGN REPORT

Project No.: 30083.00

Drawing: **PFD-P120-A803**

Rev. 

T-830  
AMINE  
TANK

P-830  
AMINE TRANSFER  
PUMP

M-830  
AMINE ADDITION  
PACKAGE

M-832  
AMMONIA ADDITION  
PACKAGE

M-834  
PHOSPHATE ADDITION  
PACKAGE

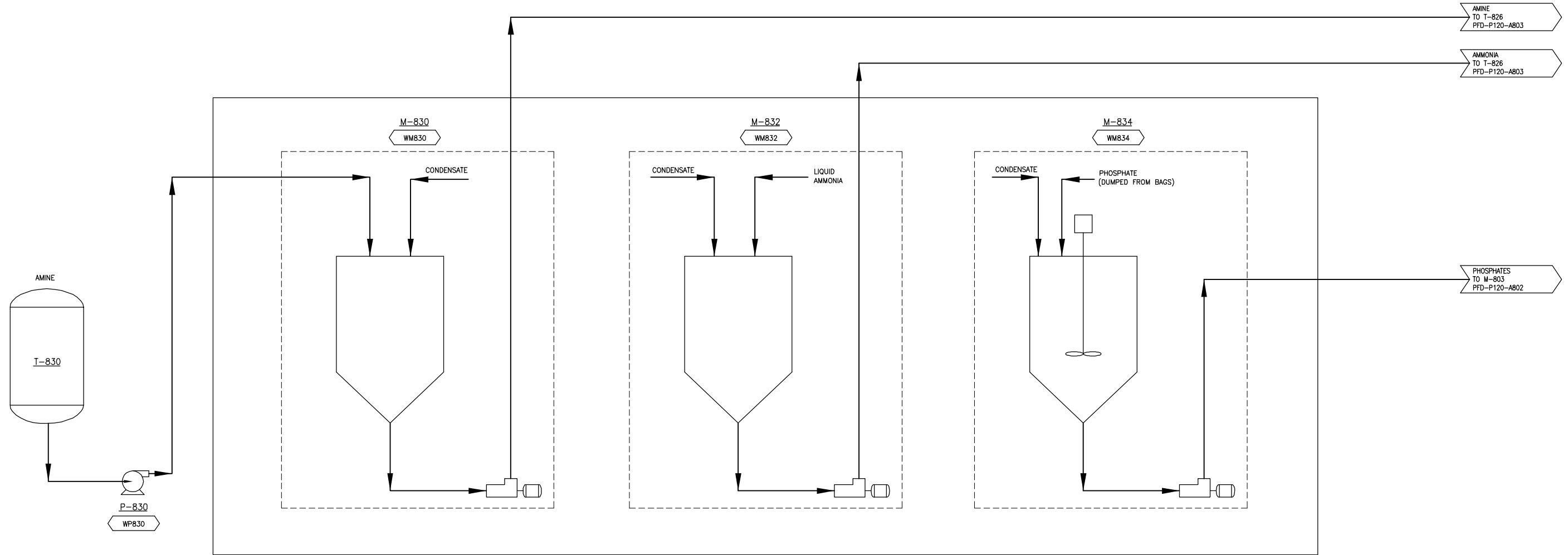

ENCLOSED IN SHED

Work Stream	kW	Gcal/hr
WM830	10	0.009
WM832	10	0.009
WM834	10	0.009
WP830	1	0.001



**Harris Group Inc.**  
Engineering for Optimum Performance®  
www.harrisgroup.com

Scale: NONE  
PMgr: DJD  
Appr: [ ]  
Drawn: JMW  
Check: [ ]  
Engr: PWS/JCL  
Check: [ ]

NATIONAL RENEWABLE ENERGY LABORATORY  
GOLDEN, COLORADO

2011 BIOCHEMICAL DESIGN REPORT

PROCESS FLOW DIAGRAM  
SECTION A800  
BOILER FEED WATER CHEMICALS

Rev.	Date	By	Description
D	4/27/11	HGI	UPDATED STREAM TABLES
C	4/21/11	HGI	ISSUED FOR 2011 DESIGN REPORT
B	4/6/11	HGI	ADDED STREAM TABLES
A	12/22/09	HGI	ISSUED FOR DESIGN REPORT

Project No.: 30083.00  
Drawing: PFD-P120-A804  
Rev: [ ]



M-902  
COOLING TOWER  
SYSTEM

P-902  
COOLING WATER  
PUMP

M-908  
CHILLED WATER  
PACKAGE

M-904  
PLANT AIR  
COMPRESSOR

S-904  
INSTRUMENT  
AIR DRYER

T-904  
PLANT AIR  
RECEIVER

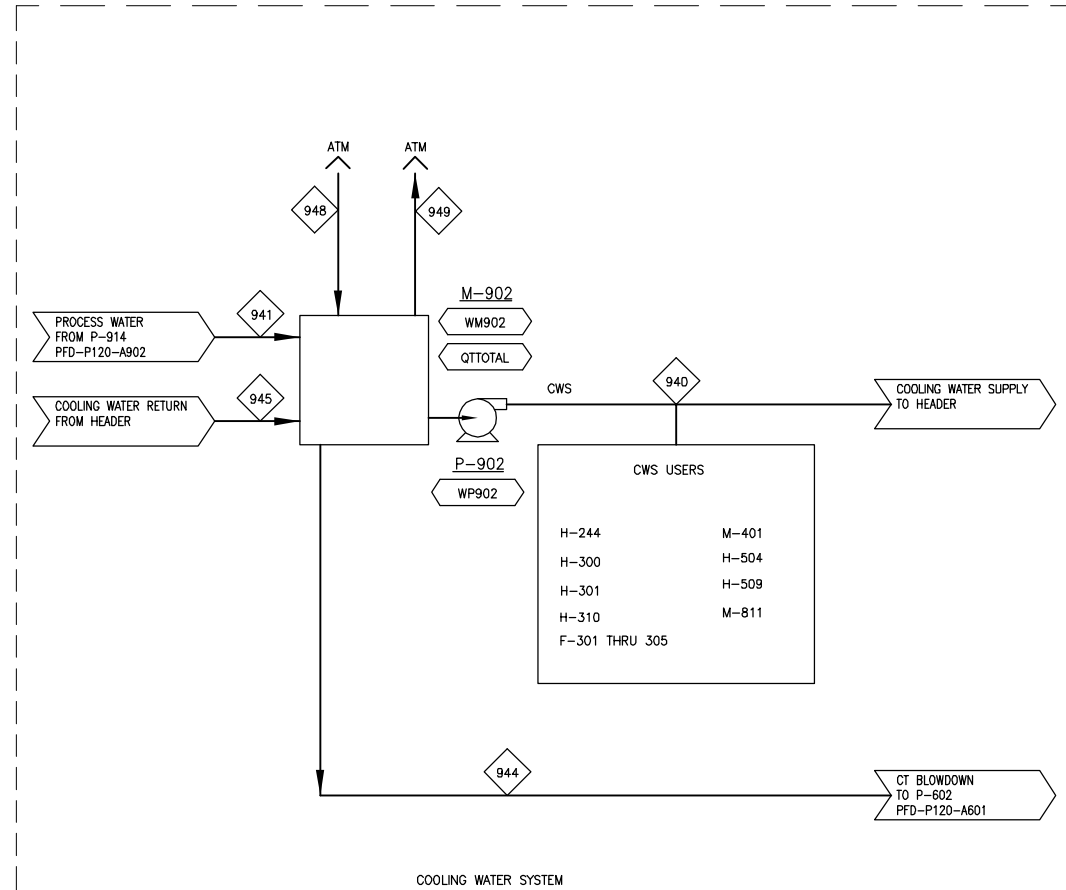

COOLING WATER SYSTEM

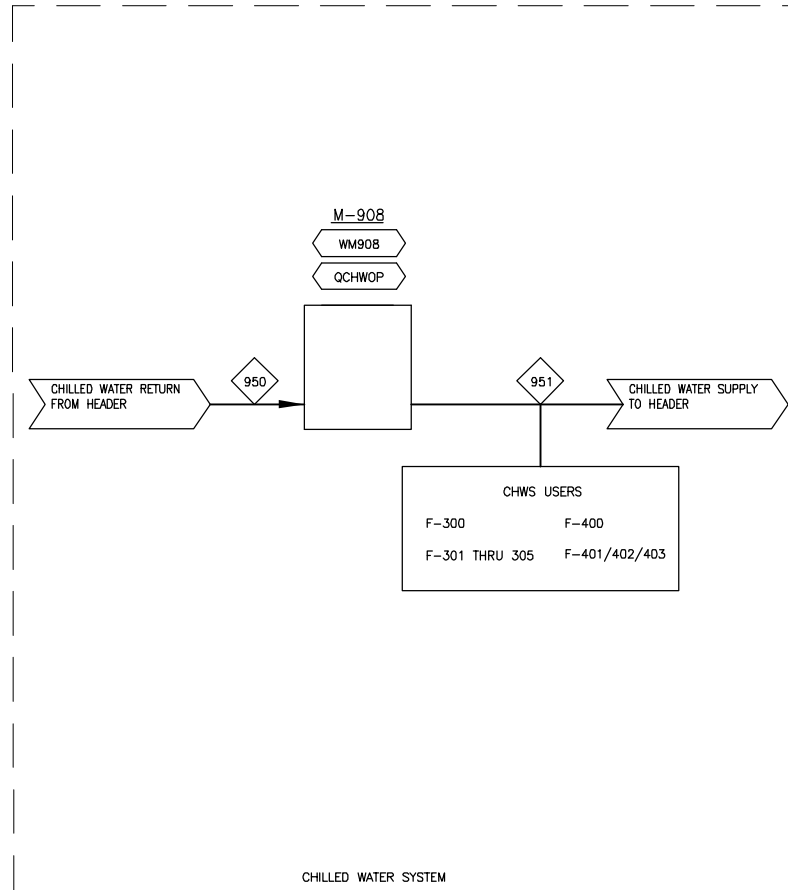

CHILLED WATER SYSTEM

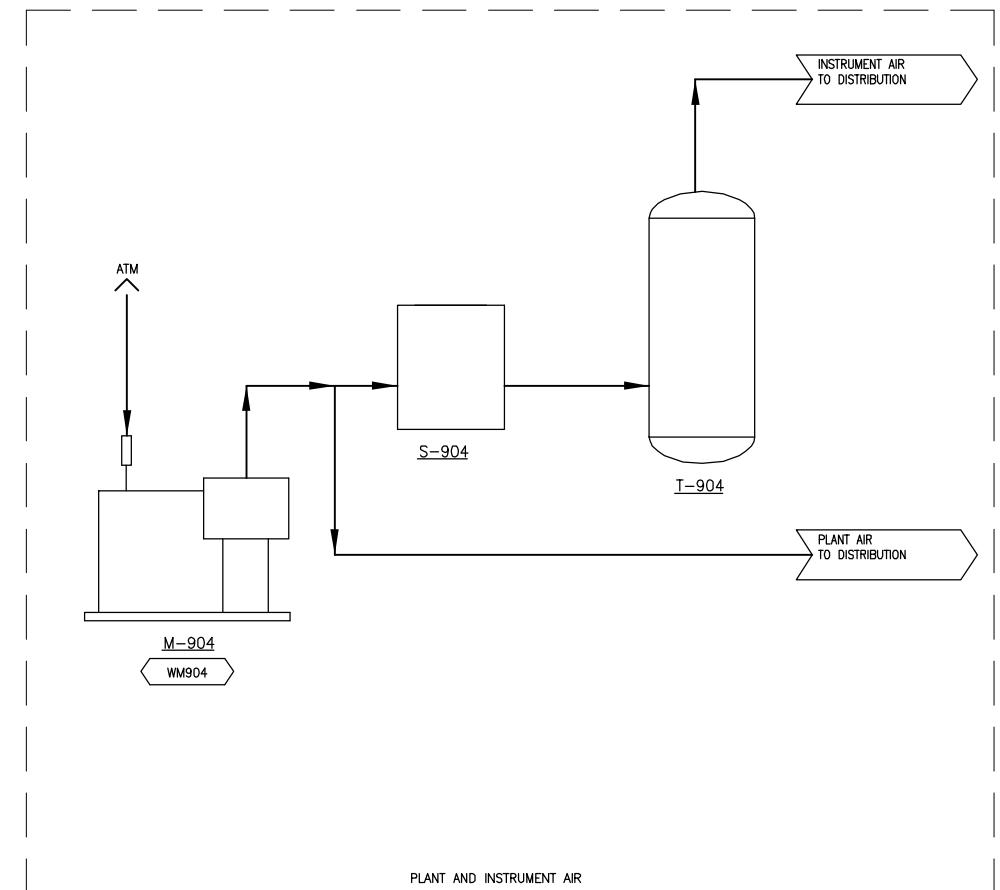

PLANT AND INSTRUMENT AIR

Ref: Date: 4/27/11 By: Section: D:\11A - Process Solutions\10-30083 NREL - Wastewater\5000 PFDs\FINAL DRAWINGS FOR PUBLICATION\PFD-P120-A901.dwg

COMPONENT	UNITS	940	941	944	945	948	949	950	951
Total Flow	kg/hr	11,923,904	155,041	17,678	11,923,904	6,549,403	6,687,697	1,372,608	1,372,608
Insoluble Solids	%	0.0%	0.0%	0.0%	0.0%	0.0%	0.0%	0.0%	0.0%
Soluble Solids	%	0.0%	0.0%	0.0%	0.0%	0.0%	0.0%	0.0%	0.0%
Temperature	°C	28	33	28	37	25	37	4	15
Pressure	atm	5.0	5.0	5.1	5.0	1.0	1.0	4.1	4.1
Vapor Fraction		0.0	0.0	0.0	0.0	1.0	1.0	0.0	0.0
Ethanol	kg/hr								
Water	kg/hr	11,923,687	155,041	17,678	11,923,687	128,274	266,568	1,372,608	1,372,608
Glucose (SS)	kg/hr								
Xylose (SS)	kg/hr								
Other sugars (SS)	kg/hr								
Sugar Oligomers (SS)	kg/hr								
Organic Soluble Solids (SS)	kg/hr								
Inorganic Soluble Solids (SS)	kg/hr								
Ammonia	kg/hr								
Acetic Acid	kg/hr								
Sulfuric Acid	kg/hr								
Furfurals	kg/hr								
Other Organics	kg/hr								
Carbon Dioxide	kg/hr								
Methane	kg/hr								
O2	kg/hr	80		0	80	1,495,590	1,495,590		
N2	kg/hr	138		0	138	4,925,539	4,925,539		
CO/SOx/NOx/H2S	kg/hr								
Cellulose (IS)	kg/hr								
Xylan (IS)	kg/hr								
Other Struct. Carbohydr. (IS)	kg/hr								
Acetate (IS)	kg/hr								
Lignin (IS)	kg/hr								
Protein (IS)	kg/hr								
Cell Mass (IS)	kg/hr								
Other Insoluble Solids (IS)	kg/hr								
Carbon Mole Flow	kmol/hr								
COD	kg/hr								
LHV @ 25°C	Gcal/hr	6898.7	89.0	10.2	6801.3	0.0	-20.3	824.1	810.6

Heat Stream	Gcal/hr	Work Stream	kW	Gcal/hr
QCHWOP	13.440	WM902	1021	0.878
QTTOTAL	97.401	WM904	186	0.160
		WM908	2489	2.140
		WP902	1598	1.374



Scale: NONE  
 PMgr: DJD  
 Appr:

Drawn: JMW  
 Check:

Engr: PWS/JCL  
 Check:

NATIONAL RENEWABLE ENERGY LABORATORY  
 GOLDEN, COLORADO

2011 BIOCHEMICAL DESIGN REPORT

PROCESS FLOW DIAGRAM  
 SECTION A900  
 COOLING WATER PLANT & INST. AIR SYSTEM

Project No.: 30083.00  
 Drawing: PFD-P120-A901  
 Rev: E

Rev.	Date	By	Description
E	4/27/11	HGI	UPDATED STREAM TABLES
D	4/21/11	HGI	ISSUED FOR 2011 DESIGN REPORT
C	4/6/11	HGI	ADDED STREAM TABLES
B	3/21/11	HGI	REVISED BASED ON NEW WWT DESIGN
A	12/22/09	HGI	ISSUED FOR DESIGN REPORT



I:\1A - Process Solutions\10-30083 NREL - Wastewater\5000 PFDs\FINAL DRAWINGS FOR PUBLICATION\FD-P120-A902.dwg  
 Br: Section, Discipline  
 Pld Date: 4/27/11

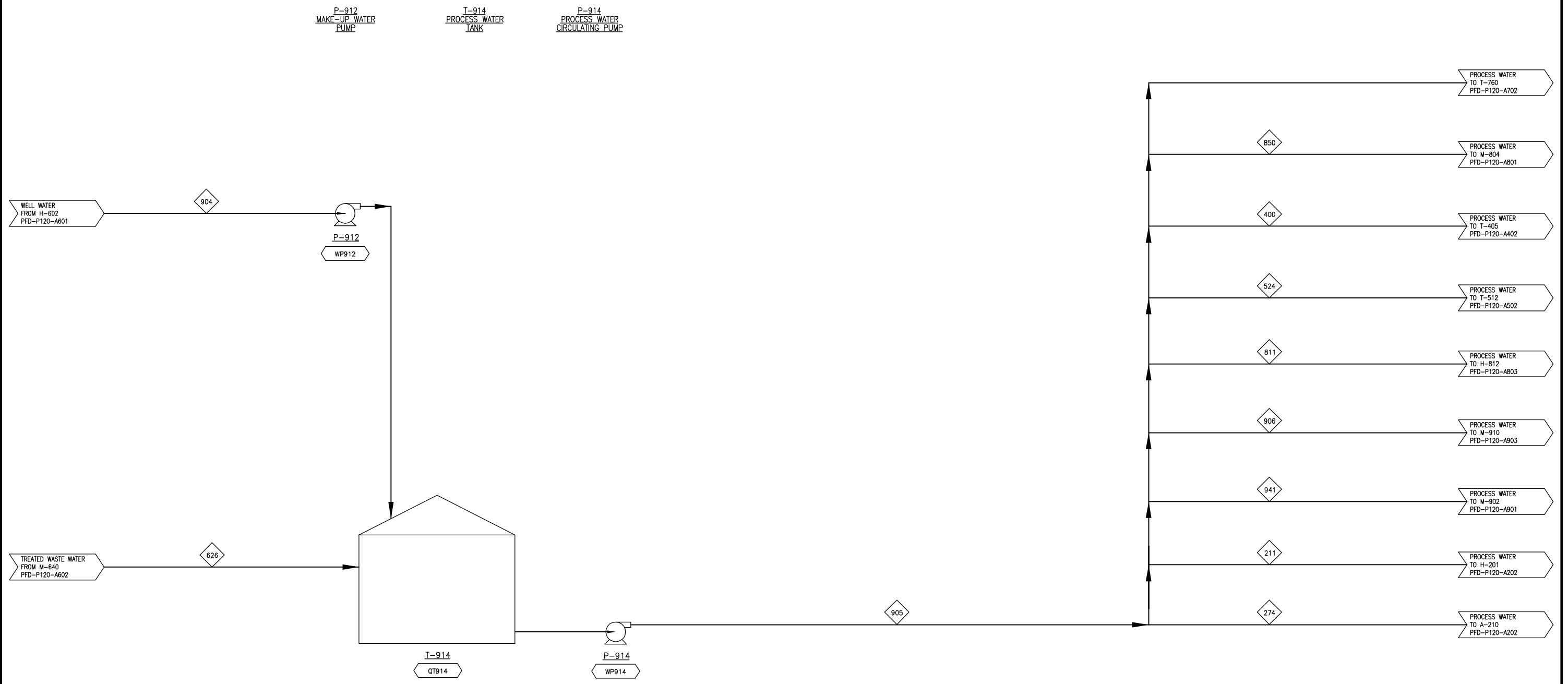

COMPONENT	UNITS	211	274	400	524	626	811	850	904	905	906	941
Total Flow	kg/hr	140,850	150,310	11,419	26,836	376,324	35,284	3,579	147,140	523,463	145	155,041
Insoluble Solids	%	0.0%	0.0%	0.0%	0.0%	0.0%	0.0%	0.0%	0.0%	0.0%	0.0%	0.0%
Soluble Solids	%	0.0%	0.0%	0.0%	0.0%	0.0%	0.0%	0.0%	0.0%	0.0%	0.0%	0.0%
Temperature	°C	33	33	33	33	27	33	33	59	33	20	33
Pressure	atm	5.0	5.0	5.0	5.0	1.0	5.0	5.0	2.0	5.0	1.0	5.0
Vapor Fraction		0.0	0.0	0.0	0.0	0.0	0.0	0.0	0.0	0.0	0.0	0.0
Ethanol	kg/hr											
Water	kg/hr	140,850	150,310	11,419	26,836	376,324	35,284	3,579	147,140	523,463	145	155,041
Glucose (SS)	kg/hr											
Xylose (SS)	kg/hr											
Other sugars (SS)	kg/hr											
Sugar Oligomers (SS)	kg/hr											
Organic Soluble Solids (SS)	kg/hr											
Inorganic Soluble Solids (SS)	kg/hr											
Ammonia	kg/hr											
Acetic Acid	kg/hr											
Sulfuric Acid	kg/hr											
Furfurals	kg/hr											
Other Organics	kg/hr											
Carbon Dioxide	kg/hr											
Methane	kg/hr											
O2	kg/hr											
N2	kg/hr											
CO/SOX/NOX/H2S	kg/hr											
Cellulose (IS)	kg/hr											
Xylan (IS)	kg/hr											
Other Struct. Carbohydr. (IS)	kg/hr											
Acetate (IS)	kg/hr											
Lignin (IS)	kg/hr											
Protein (IS)	kg/hr											
Cell Mass (IS)	kg/hr											
Other Insoluble Solids (IS)	kg/hr											
Carbon Mole Flow	kmol/hr											
COD	kg/hr											
LHV @ 25°C	Gcal/hr	80.8	86.3	6.6	15.4	218.1	20.3	2.1	80.8	300.5	0.1	89.0

Rev.	Date	By	Description
E	4/27/11	HGI	UPDATED STREAM TABLES
D	4/21/11	HGI	ISSUED FOR 2011 DESIGN REPORT
C	4/6/11	HGI	ADDED STREAM TABLES
B	3/21/11	HGI	REVISED FOR FGD SYSTEM
A	12/22/09	HGI	ISSUED FOR DESIGN REPORT

Heat Stream	Gcal/hr	Work Stream	kW	Gcal/hr
QT914	1.615	WP914	72	0.062



**NREL**  
NATIONAL RENEWABLE ENERGY LABORATORY



**Harris Group Inc.**  
Engineering for Optimum Performance®  
www.harrisgroup.com

Scale: NONE  
 PMgr: DJD      Drawn: JMW      Engr: PWS/JCL  
 Appr:              Check:              Check:

**NATIONAL RENEWABLE ENERGY LABORATORY  
GOLDEN, COLORADO**

**2011 BIOCHEMICAL DESIGN REPORT**

**PROCESS FLOW DIAGRAM  
SECTION A900  
PROCESS WATER**

Project No.: 30083.00	Drawing: PFD-P120-A902	Rev: 
-----------------------	------------------------	--

M-910  
CIP  
SYSTEM

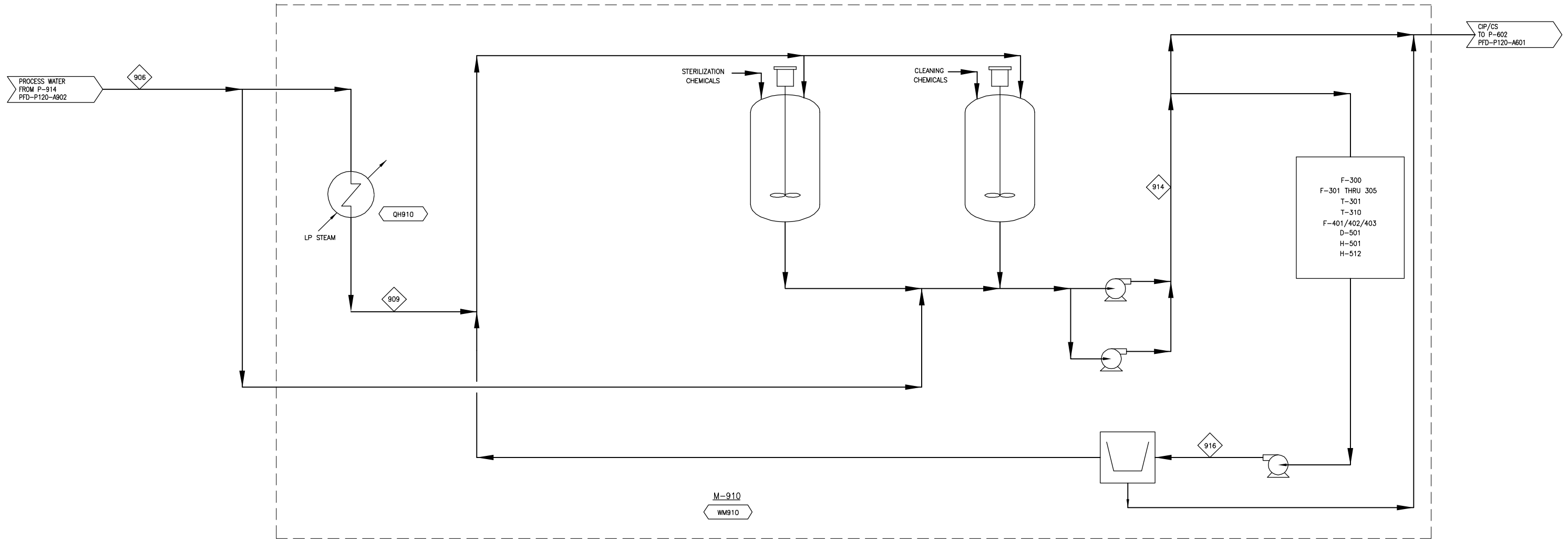

I:\1A - Process Solutions\10-30083\_NREL - Wastewater\5000\_PFDs\FINAL DRAWINGS FOR PUBLICATION\PFD-P120-A903.dwg  
 Br. Section: Detailed  
 Date: 4/27/11

COMPONENT	UNITS	906	909	914	916
Total Flow	kg/hr	145	145	145	145
Insoluble Solids	%	0.0%	0.0%	0.0%	0.0%
Soluble Solids	%	0.0%	0.0%	0.0%	0.0%
Temperature	°C	20	121	20	20
Pressure	atm	1.0	1.0	1.0	1.0
Vapor Fraction		0.0	1.0	0.0	0.0
Ethanol	kg/hr				
Water	kg/hr	145	145	145	145
Glucose (SS)	kg/hr				
Xylose (SS)	kg/hr				
Other sugars (SS)	kg/hr				
Sugar Oligomers (SS)	kg/hr				
Organic Soluble Solids (SS)	kg/hr				
Inorganic Soluble Solids (SS)	kg/hr				
Ammonia	kg/hr				
Acetic Acid	kg/hr				
Sulfuric Acid	kg/hr				
Furfurals	kg/hr				
Other Organics	kg/hr				
Carbon Dioxide	kg/hr				
Methane	kg/hr				
O2	kg/hr				
N2	kg/hr				
CO/SOx/NOx/H2S	kg/hr				
Cellulose (IS)	kg/hr				
Xylan (IS)	kg/hr				
Other Struct. Carbohydr. (IS)	kg/hr				
Acetate (IS)	kg/hr				
Lignin (IS)	kg/hr				
Protein (IS)	kg/hr				
Cell Mass (IS)	kg/hr				
Other Insoluble Solids (IS)	kg/hr				
Carbon Mole Flow	kmol/hr				
COD	kg/hr				
LHV @ 25°C	Gcal/hr	0.1	0.0	0.1	0.1



Heat Stream	Gcal/hr	Work Stream	kW	Gcal/hr
QH910	-0.091	WM910	250	0.215

**Harris Group Inc.**  
Engineering for Optimum Performance®  
www.harrisgroup.com

Scale: NONE  
 PMgr: DJD  
 Appr: [Signature]      Drawn: JMW      Engr: PWS/JCL  
 Check: [Signature]      Check: [Signature]

**NATIONAL RENEWABLE ENERGY LABORATORY**  
GOLDEN, COLORADO

**2011 BIOCHEMICAL DESIGN REPORT**

**PROCESS FLOW DIAGRAM**  
SECTION A900  
STERILE WATER & CIP/CS SYSTEMS

Project No.: 30083.00      Drawing: PFD-P120-A903      Rev: E

Rev.	Date	By	Description
E	4/27/11	HGI	UPDATED STREAM TABLES
D	4/21/11	HGI	ISSUED FOR 2011 DESIGN REPORT
C	4/6/11	HGI	ADDED STREAM TABLES
B	3/21/11	HGI	REVISED BASED ON NEW WWT DESIGN
A	12/22/09	HGI	ISSUED FOR DESIGN REPORT