



Stormwater BMPs for Vegetative Biofilters

Course Number: CE-02-309

PDH: 16

Approved for: AK, AL, AR, FL, GA, IA, IL, IN, KS, KY, LA, MD, ME, MI, MN, MO, MS, MT, NC, ND, NE, NH, NJ, NM, NV, NY, OH, OK, OR, PA, SC, SD, TN, TX, UT, VA, VT, WI, WV, and WY

New Jersey Professional Competency Approval #24GP00025600

North Carolina Approved Sponsor #S-0695

Maryland Approved Provider of Continuing Professional Competency

Indiana Continuing Education Provider #CE21800088

Florida Provider #0009553 License #868

NYSED Sponsor #274

This document is the course text. You may review this material at your leisure before or after you purchase the course. In order to obtain credit for this course, complete the following steps:

- 1) Log in to My Account and purchase the course. If you don't have an account, go to New User to create an account.
- 2) After the course has been purchased, review the technical material and then complete the quiz at your convenience.
- 3) A Certificate of Completion is available once you pass the exam (70% or greater). If a passing grade is not obtained, you may take the quiz as many times as necessary until a passing grade is obtained (up to one year from the purchase date).

If you have any questions or technical difficulties, please call (508) 298-4787 or email us at admin@PDH-Pro.com.



Stormwater Best Management Practice Design Guide Volume 2 Vegetative Biofilters

By

Michael L. Clar
Exocite, Inc.
Ellicott City, MD 21042

Billy J. Barfield
Department of Biosystems and Agricultural Engineering
Oklahoma State University
Stillwater, OK 74074

Thomas P. O'Connor
Water Supply and Water Resources Division
National Risk Management Research Laboratory
Edison, NJ 08837

Order No. 1C-R059-NTSX

Project Officer

Thomas P. O'Connor
Water Supply and Water Resources Division
National Risk Management Research Laboratory
Edison, NJ 08837

National Risk Management Research Laboratory
Office of Research and Development
U.S. Environmental Protection Agency
Cincinnati, OH 45268

Abstract

This document is Volume 2 of a three volume document that provides guidance on the selection and design of stormwater management Best Management Practices (BMPs). This second volume provides specific design guidance for a group of onsite BMP control practices that are referred to as vegetative biofilters and includes the following BMP control practices:

- grass swales
- filter and buffer strips
- bioretention cells

Historically vegetative biofilters, such as grass swales, were used primarily for stormwater conveyance (Ree, 1949, Chow, 1959 and Temple, 1987). However with the passage of the Clean Water Act, and the focus on water quality management of urban runoff, the potential for the application of these techniques has begun to be reconsidered and many additional benefits have been identified. Today biofilters are being applied to address all of the design objectives of urban stormwater management. These include: reduction of urban runoff impacts, groundwater recharge, water quality control, stream channel protection and peak discharge control (for both small storms e.g., 6-month and 1-yr frequency storms, and large storms e.g., 2-, 10- and 100-yr storms). The most common application of the biofilters, however, is typically their use as the first stage of the treatment train approach described in Volume 1, and their purpose is to address groundwater recharge and water quality control for small headwater areas.

Three different types of vegetated biofilter BMP types have been identified and are described in this manual. These include: 1) grass swales, 2) vegetated filter strips and 3) bioretention cells. In addition grass swales contain three variations that include: 1) traditional grass swales, 2) grass swale with a media filter and 3) wet swales. Thus a total of five BMP types are available for use and are described in this manual.

Contents

Notice	ii
Foreword	iii
Abstract	iv
Contents	v
List of Figures	ix
List of Tables	xi
Acronyms and Abbreviations	xiii
Acknowledgments	xv
Executive Summary	1
Section One Introduction	1 - 1
Section Two Vegetated Biofilter Types	2 - 1
Overview	2 - 1
Grass Swales	2 - 1
Dry Swale with Filter Media	2 - 1
Wet Swales	2 - 2
Vegetative Filter Strips	2 - 2
Bioretention	2 - 2
Section Three General Design Considerations	3 - 1
Introduction	3 - 1
Design Flow Volumes and Rates	3 - 1
Design to Reduce Hydrologic Regime Alterations	3 - 1
Design to Provide Water Quality Management	3 - 5
Flow Regulation	3 - 7
Pretreatment	3 - 8
Protection of Biofilter System	3 - 9
Receiving Waterway	3 - 9
Design to Reduce Stream Channel Erosion	3 - 9
Suitability and Selection Considerations	3 - 10
Land Use Factors	3 - 10
Site Conditions	3 - 10
Comparative Pollutant Removal Capability	3 - 12

Section Four Analysis Procedures for Runoff and Pollutant Loading	4 - 1
Introduction	4 - 1
Runoff Volumes and Rates	4 - 1
Single Storm vs. Continuous Simulation vs. Storm Probabilities	4 - 1
Runoff Coefficient Approach to Runoff Volume	4 - 4
NRCS Curve Number Approach to Runoff Volume	4 - 4
	4 - 5
Runoff Rates and Peak Discharge	4 - 6
Loading Calculations for Sediment	4 - 11
Definition of Sediment Load by Locally Collected Empirical Data	4 - 11
Definition of Sediment Load by Using Models and National Database	4 - 13
Size Distribution of Sediment	4 - 16
Eroded Sediment Size Distribution by Modeling	4 - 17
Composite Eroded Size Distribution	4 - 19
Loading Calculations for Nutrients and Other Chemicals	4 - 20
Developing Nutrient Loading by Locally Collected Empirical Data	4 - 20
Developing Nutrient Loading from National Database EMCs	4 - 20
Total Loading	4 - 21
Settleable Fraction of EMC	4 - 21
Isotherms for Distributing Nitrogen and Phosphorus Between the Dissolved and Sorbed Phase	4 - 22
	4 - 22
Composite Nutrient and Pollutant Yield for Pervious and Impervious Areas	4 - 23
Example Problems on Runoff and Loading	4 - 23
Section Five Vegetative Filter Strips	5 - 1
Factors That Affect VFS Performance	5 - 3
Flow Rate and Drainage Area	5 - 3
Development Conditions	5 - 4
Soils and Infiltration Rate	5 - 4
Topography	5 - 4
Depth of Water Table	5 - 4
Vegetation and Climate	5 - 5
Pollutant Removal Capabilities	5 - 5
Design Guidance	5 - 6
Design Chart Procedure	5 - 6
The Maryland Stormwater Credit Approach	5 - 9
Urban Drainage and Flood Control District Procedure for Denver Region	5 - 11
IDEAL Analysis Procedures for Vegetative Biofilters	5 - 15
Hydraulic Routing in Grassed Swales and Vegetative Filters	5 - 15
Flow Velocities	5 - 17
Sediment Routing	5 - 23
Chemical Pollutants Routing	5 - 27
Example Problems on VFS and Bioswales	5 - 29
Other System Components	5 - 39
Level Spreader	5 - 39
Pervious Berm	5 - 39
Vegetation	5 - 40
Construction Guidelines	5 - 42
Sequence of Construction	5 - 42

Soil Preparation	5 - 42
Maintenance	5 - 42
Maintenance/Inspection Guidelines	5 - 42
Cost Considerations	5 - 43
 Section Six Grass Swales	 6 - 1
Introduction	6 - 1
Site Considerations	6 - 3
Soil Permeability	6 - 4
Topography and Slope	6 - 4
Pollutant Removal	6 - 5
Performance Factors	6 - 6
Soil Type	6 - 6
Vegetation Type	6 - 6
Pollutant Constituents	6 - 6
Flow Rate and Runoff Contact	6 - 6
Use of Check Dams	6 - 6
Design Guidance	6 - 6
Denver Urban Drainage and Flood Control District Procedure	6 - 7
Design Example 6.1: Grass Swale Design Procedure Form	6 - 8
The Washington State Design Approach	6 - 11
Design Example 6.2: Trapezoidal Grassed Swale	6 - 18
The IDEAL Model Analysis Procedures for Vegetative Biofilters	6 - 21
Example Problem 6.3: Hydraulic Design of a Bioswale	6 - 21
Swale Enhancements	6 - 22
Check Dams	6 - 22
Design Example 6.4: Grassed Swale with Check Dams	6 - 22
Flow Bypass	6 - 24
Riprap	6 - 24
BMP Combinations	6 - 25
Maintenance	6 - 25
Seasonal Mowing and Lawn Care	6 - 26
Inspection	6 - 26
Debris and Litter Removal	6 - 26
Sediment Removal	6 - 26
Grass Re-seeding and Mulching	6 - 26
Cost Considerations	6 - 26
 Section Seven Bioretention	 7 - 1
Introduction	7 - 1
Alternative Applications	7 - 1
Pollutant Removal	7 - 3
System Components	7 - 5
Flow Regulation	7 - 7
Street or Parking Lot Runoff	7 - 7
Channel Flow	7 - 9
Pretreatment	7 - 9
Shallow Ponding Area	7 - 9
Minimum Sizing Guidance	7 - 9

Filter Bed Design	7 - 10
Infiltration Bed Design	7 - 11
Surface Mulch Layer	7 - 12
Planting Soil Bed Characteristics	7 - 12
Soil Amendments	7 - 13
Planting Material	7 - 13
Plant Installation	7 - 16
Gravel Underdrains	7 - 16
Overflow System	7 - 17
Material and Other Bioretention Specifications	7 - 17
Maintenance Guidelines	7 - 18
Mulch Layer	7 - 18
Planting Soil Bed	7 - 18
Planting Materials	7 - 19
Pretreatment, Inflow Locations and Overflow	7 - 19
Cost Considerations	7 - 19
Assumptions Used in Cost Estimates	7 - 20
 Section 8 References	 8 - 1
 Appendix A General Landscaping Guidance for Best Management Practices	 A - 1
 Appendix B Specifications for Grassed Swales and Filter Strips	 B - 1
 Appendix C Testing Requirements for Subsoils for Infiltration	 C - 1

List of Figures

Figure 2-1	Grass Swale	2 - 3
Figure 2-2	Dry Swale with Filter Media	2 - 4
Figure 2-3	Wet Swale	2 - 5
Figure 2-4	Vegetative Filter Strip	2 - 6
Figure 2-5	Bioretention Cell	2 - 7
Figure 3-1	Comparison of Land Cover for Conventional and Low Impact Development	3 - 3
Figure 4-1	Meadows Alternative to TR-55 which takes into Account Peak Rate Factors	4 - 10
Figure 4-2	Phosphorus Partitioning	4 - 38
Figure 4-3	Nitrogen Partitioning	4 - 39
Figure 5-1	Conceptual Filter Strip	5 - 2
Figure 5-2	Parking Lot Filter Strip, Tampa Bay Aquarium	5 - 2
Figure 5-3	Pollutant Removal Efficiency Versus Filter Strip Length	5 - 6
Figure 5-4	Removal rates (TR) for Buffer Strips	5 - 8
Figure 5-5	Maryland Buffer Strip	5 - 10
Figure 5-6	Grass Buffer	5 - 11
Figure 5-7	UDFCD Grass Buffer Schematic	5 - 12
Figure 5-8	Standard Definitions of Channel Parameters	5 - 20
Figure 5-9	Manning's n Versus VR for Various Retardance Classes	5 - 21
Figure 5-10	Solution to Manning's Equation for Retardance Class C	5 - 22
Figure 5-11	Plot of Data for Kentucky Grassfill Model	5 - 25
Figure 5-12	Particle Size Class Change in Flow through Filter	5 - 34
Figure 5-13	Strip Mall Development for Example Problem 5.3	5 - 35
Figure 5-14	IDEAL Input for Area, Land Use, Hydrologic Information, EMC and Isotherm Data for Example Problem 5.3	5 - 36
Figure 5-15	IDEAL Input for Vegetative Filter Strip Information for Example Problem 5.3	5 - 37
Figure 5-16	Runoff and Peak Discharge into and from Vegetated Filter Strip for Example 5.3	5 - 37
Figure 5-17	Sediment Loading into and Discharge from Vegetated Filter Strip for Example 5.3	5 - 38
Figure 5-18	Pollutant Loading into and Discharge from Vegetated Filter Strip for Example 5.3	5 - 38
Figure 5-19	Level Spreader	5 - 40
Figure 6-1	Grass Swale	6 - 1
Figure 6-2	Grass Swale with Check Dam	6 - 2
Figure 6-3	Grass Swale with Check Dams	6 - 3
Figure 6-4	Typical Grass Swale	6 - 8
Figure 6-5	Grass Swale Profile and Section	6 - 9
Figure 6-6	Channel and Flow Geometry for a Trapezoid Swale	6 - 13
Figure 6-7	Typical Swale with Check Dam Configuration	6 - 24
Figure 6-8	Typical Check Dam Configurations	6 - 25
Figure 7-1	Typical Applications of Bioretention Systems	7 - 2

Figure 7-2 Bioretention Application on a Single Family Lot	7 - 3
Figure 7-3 Bioretention Application on New Parking Lot	7 - 4
Figure 7-4 Bioretention Application to Retrofit an Existing Parking Lot	7 - 4
Figure 7-6 Bioretention Area with Slotted Curb Flow Diversion System	7 - 7
Figure 7-7 Inlet Deflector Detail	7 - 8

List of Tables

Table 3-1	Pretreatment Components for Vegetative Biofilter Practices	3 - 8
Table 3-2	Land Use and Biofilter Suitability	3 - 11
Table 3-3	Physical Site Conditions and Biofilter Suitability	3 - 11
Table 3-4	Estimated Pollutant Removal Capability of Biofilters (%)	3 - 12
Table 4-1	Example Precipitation Probability Values	4 - 3
Table 4-2	Runoff Curve Numbers for Urban Areas	4 - 6
Table 4-3	Regression Equations for Coefficients in Equation 4-10b	4 - 7
Table 4-4	Coefficient “a” for Overland Flow Equation	4 - 8
Table 4-5	Peak Rate Factors	4 - 10
Table 4-6	Typical Values for <i>CP</i> for Equation 4-25	4 - 15
Table 4-7	Event Mean Concentrations for TSS	4 - 16
Table 4-8a	Representative Diameters by Classes Based on Soil Matrix Fractions	4 - 17
Table 4-8b	Fraction of Sediment by Class Based on Soil Matrix Fractions	4 - 18
Table 4-9	Diameters and Settling Velocities for Sediment (TSS) from Impervious Areas	4 - 19
Table 4-10	Fraction of Clay Within Particle Classes in Table 4-8b	4 - 19
Table 4-11	Event Mean Concentrations for Nitrogen, Phosphorus and Indicator Bacteria	4 - 21
Table 4-12	Example Isotherm Values for Coastal South Carolina	4 - 22
Table 4-13	Precipitation Information and Probabilities and Spreadsheet Calculations	4 - 28
Table 4-14	Expected Value of Runoff and Peak Discharge for a Precipitation Class of 0.75 inches for Example Problem 4.2	4 - 29
Table 4-15	Expected Value of Runoff and Peak Discharge for a Precipitation Class of 0.75 in. for Example Problem 4.2	4 - 29
Table 4-16	Fraction of Sediment by Class Based on Soil Matrix Fractions for Example Problem 4.3	4 - 32
Table 4-17	Representative Diameters by Classes Based on Soil Matrix Fractions for Example Problem 4.3	4 - 32
Table 4-18	Calculation of Mass of Clay Sized Particles in Discharge for Example Problem 4.3	4 - 33
Table 4-19	Summary of Loading for Example Problems 4.1- 4.5	4 - 37
Table 5-1	Multiplicative Adjustments in Length for Various Soil Type	5 - 7
Table 5-2	Steady-State Infiltration Rates for Analyzing Vegetative Filter Strips and Grass Swales	5 - 16
Table 5-3	Hydraulic Input Information for Vegetative Filters	5 - 18
Table 5-4	Values of index, <i>I</i> , for Equation 5-18	5 - 20
Table 5-5	Permissible Velocities (ft/s) for Grass Swales	5 - 23
Table 5-6	Sediment Load Concentration and Particle Size	5 - 31
Table 5-7	Mass of Effluent for Each Class Size	5 - 33
Table 5-8	Tabulated Results of Effect of Fraction Class	5 - 34
Table 5-9	Example Isotherm Values for Coastal South Carolina	5 - 35
Table 5-10	Rainfall Probability Based on Cumulative Storm Depth for Beaufort, SC	5 - 36
Table 6-1	Guide for Selecting Maximum Permissible Swale Velocities for Stability	6 - 4
Table 6-3	Design Parameters for Swale	6 - 11
Table 6-4	Example Criteria for Turf Grass Cover	6 - 16
Table 6-5	Grass Coverage, Height, and Degree of Retardance	6 - 17
Table 7-1	Pollutant Removal Performance of Bioretention Practices (% Removal Rates)	7 - 3

Table 7-2 Recommended Sizing Guidance for Bioretention Facilities	7 - 10
Table 7-3 Planting Soil Characteristics (Clar et al., 1993)	7 - 13
Table 7-4 Commonly Used Species for Bioretention Areas	7 - 15
Table 7-5 Planting Plan Design Considerations	7 - 15
Table 7-6 Planting Specification Issues	7 - 16
Table 7-7 Materials Specifications	7 - 17
Table 7-8 Bioretention Planting Specifications	7 - 18
Table 7-8 Typical Bioretention Costs (Winogradoff, 2001)	7 - 20

Acronyms and Abbreviations

APWA	= American Public Works Association
ASCE	= American Society of Civil Engineers
BMP	= Best Management Practice
BOD	= Biochemical Oxygen Demand
CERCLA	= Comprehensive Environmental Response, Compensation and Liability Act
COD	= Chemical Oxygen Demand
CREAMS	= A field scale model for Chemicals, Runoff, and Erosion from Agricultural Management Systems
CUHP	= Colorado Urban Hydrograph Procedure
CWA	= Clean Water Act
CZARA	= Coastal Zone Act Reauthorization Amendments
CZMA	= Coastal Zone Management Act
DCIA	= Directly Connected Impervious Area
EIS	= Environmental Impact Statement
EPA	= Environmental Protection Agency
EPT	= Ephemeroptera (mayflies), Plecoptera (stoneflies) and Trichoptera (caddisflies)
ESA	= Endangered Species Act
EMC	= Event Mean Concentration
FBI	= Family Biotic Index
FEMA	= Federal Emergency Management Agency
FIFRA	= Federal Insecticide, Fungicide and Rodenticide Act
FWPCA	= Federal Water Pollution Control Act
HPA	= Hydraulic Project Approval
HSPF	= Hydrologic Simulation Program Formulation
ILLUDAS	= The Illinois Urban Area Simulator
IPM	= Integrated Pest Management
IDF	= Intensity Duration Frequency
MDE	= Maryland Department of the Environment
MEP	= Maximum Extent Practicable
MS4	= Municipal Separate Storm Sewer System
MTBE	= Methyl Tertiary Butyl Ether
MUSLE	= Modified Universal Soil Loss Equation
NEPA	= National Environmental Policy Act
NGPE	= Native Growth Protection Easement
NMFS	= National Marine Fisheries Service
NOAA	= National Oceanographic and Atmospheric Administration
NPDES	= National Pollution Discharge Elimination Program
NPS	= Non Point Source
NRCS	= Natural Research Council Service
NRDC	= National Resource Defense Council, Inc.

NURP	= Nationwide Urban Runoff Program
OCZM	= Office of Coastal Zone Management
OPA	= Oil Pollution Act
PAH	= Poly Aromatic Hydrocarbons
PSRM	= Penn State Runoff Model
RCRA	= Resource Conservation and Recovery Act
RFS	= Rainfall Frequency Spectrum
RPD	= Rain Point Diagram
RVPD	= Runoff Volume Point Diagram
SBUH	= Santa Barbara Urban Hydrograph
SCS	= Soil Conservation Service
SD	= Settling Depth
SLAMM	= Source Loading and Management Model
SS	= Suspended Solids (also TSS = Total Suspended Solids)
SSP	= Stormwater Site Plan
SUBH	= Santa Barbara Urban Hydrograph
SWM	= Stormwater Management
SWMM	= Stormwater Management Model
SWPPP	= Stormwater Pollution Prevention Plan
TESC	= Temporary Erosion and Sediment Control
TIA	= Total Impervious Area
TMDL	= Total Maximum Daily Loads
TPH	= Total Petroleum Hydrocarbons
TN	= Total Nitrogen
TP	= Total Phosphorus
UDFCD	= Urban Drainage Flood Control District
USDA	= U.S. Department of Agriculture
USFWS	= U.S. Fish and Wildlife Service
USGS	= U.S. Geological Survey
WAC	= Washington Administrative Code
WEF	= Water Environment Federation
WERF	= Water and Environment Research Foundation
WEPP	= Water Erosion Prediction Model
WMS	= Watershed Modeling System
WQS	= Water Quality Standards
WSDOT	= Washington State Department of Transportation
WWF	= Wet Weather Flow

Acknowledgments

These stormwater management control practices, or best management practices (BMPs) design guidelines were prepared by Ecosite, Inc. under a contract with the Urban Watersheds Management Branch, Water Supply and Water Resources Division, National Risk Management Research Laboratory, Edison, New Jersey.

A major undertaking of this type requires the dedication and cooperation of many individuals. The technical direction and coordination for this project was provided by the technical project team of the Urban Watershed Management Branch, under the direction of Mr. Thomas P. O'Connor, the technical project officer. Many members of the branch assisted in making this product available to the public. Special recognition is also extended to the other members of the branch, which included:

- Mr. Daniel Sullivan, P.E., Former Branch Chief (retired)
- Mr. Richard Field, P.E., Senior Advisor
- Dr. Dennis Lai, P.E., Senior Engineer
- Mr. Michael Borst, P.E., Senior Engineer
- Mr. Evan Fan, P.E., Senior Engineer (retired)
- Dr. Ariamalar Selvakumar, P.E., Environmental Engineer

The Ecosite project team included Michael L. Clar, P.E., project manager, and Dr. Bill Barfield, P.E., Professor Emeritus, Oklahoma State University.

Thanks to the external peer reviewers Gene Driscoll, P.E. and Ben Urbonas, P.E. and Office of Water Jesse Pritts, Norbert Huang and King Boynton. Dr. Swarna Muthukrishnan checked example problem calculations. Judy Norinsky and Jatu Bracewell edited the final draft. Carolyn Esposito and Asim Ray performed QA review.

The objective of the project was to identify and build upon existing guidance documents scattered throughout the United States. A number of excellent publications were identified and have been referenced extensively throughout this document. The authors wish to acknowledge the previous work and contributions in the field of stormwater management of the following organizations:

- U.S. Environmental Protection Agency
- Urban Water Resources Research Council, American Society of Civil Engineers
- U.S. Federal Highway Administration
- Water Environment Federation
- Maryland Department for the Environment
- Denver Urban Drainage and Flood Control District.



EXECUTIVE SUMMARY

As this document is being published by U.S. Environmental Protection Agency's (EPA) Office of Research and Development, its primary focus is not the promulgation of regulation or the enforcement of policy. Instead, this is a forward looking document that tries to develop ways to address water quality issues of best management practices (BMPs) in the absence of a complete regulatory framework. The intended audience for this document are the municipal planners, regulators and watershed managers who will be deciding how BMPs will be applied in their locality.

In the past, BMP models were purely hydrologic; now they require two components: hydrology and quality. The purpose of this document is two-fold:

1. to present the state-of-the-practice for BMP design for water quality control
2. to aid the end user in making better choices.

This document is Volume 2 of a three-volume series that provides guidance on the selection and design of stormwater management BMPs. This first volume provides general considerations associated with the selection and design of BMPs.

Volume 2 provides specific design guidance for a group of onsite BMP control practices that are referred to as vegetative biofilters and includes the following BMP control practices:

- grass swales
- filter and buffer strips
- bioretention cells.

Volume 3 provides specific guidance for pond type BMPs, which are the most widely used type of BMP. The pond types that are covered include:

- extended detention basins (dry)
- retention ponds (wet)
- constructed wetland ponds
- infiltration basins.

This volume is also the only volume that contains the full storm routing which is applicable to all treatment controls detailed in Volume 2 and 3.

The purpose of this three-volume series is to guide the selection of BMPs that will be effective in preventing or mitigating the adverse impacts of urbanization either through retrofitting of existing BMPs or application of newly constructed BMPs to new development. There is sufficient evidence to indicate that urbanization is causing environmental impacts. Existing BMP technologies can resolve some of the impacts. There are continuing innovative BMP efforts such as bioretention, infiltration basins and low impact development that are being pursued at the research level, and in some actual applications, which should improve our ability to reduce or prevent impacts due to urbanization and land-use changes.

The authors have also developed a spreadsheet tool - Integrated Design and Assessment for Environmental Loadings (IDEAL) - which can aid the reader in examining the hydrology, sedimentology and water quality for BMP devices. Aspects of the capabilities of the IDEAL spreadsheet tool are demonstrated through the use of relevant equations for BMP water quality design and several examples as presented in Volume 2 and Volume 3.

Section One Introduction

This manual is Volume 2 of a three volume document that provides guidance on the design of best management practices (BMPs) for mitigation of the environmental impacts to receiving waters associated with urban runoff. Volume 1 presents general design considerations associated with the selection and use of BMPs. Volume 3 presents design considerations related to the use of Pond BMPs. This volume provides design guidelines for a group of stormwater management (SWM) best management practices (BMPs) broadly referred to as vegetative biofilters.

Historically vegetative biofilters, such as grass swales, were used primarily for stormwater conveyance (Ree, 1949, Chow, 1959, Temple, 1987). However, with passage of the Clean Water Act (CWA) and the focus on water quality management of urban runoff, the potential for application of these techniques has begun to be reconsidered and many additional benefits have been identified. Today biofilters are being applied to address all of the design objectives of urban SWM. These include: reduction of urban runoff impacts, groundwater recharge, water quality control, stream channel protection and peak discharge control (for both small storms, e.g., 6-month and 1-yr frequency storms, and large storms, e.g., 2-, 10- and 100-yr storms). The most common application of the biofilters is typically their use as the first stage of the treatment train approach, as described in Volume 1, and their purpose is to address groundwater recharge and water quality control for small headwater areas.

Three different types of vegetative biofilter BMP types have been identified and are described in this manual. These include: 1) grass swales, 2) vegetated filter strips and 3) bioretention cells. In addition, grass swales contain three variations: 1) traditional grass swales, 2) grass swale with a media filter and 3) wet swales. Thus a total of five BMP types are available for use and are described in this manual. Section 2 of the manual provides a brief introduction to each of these vegetative biofilter BMPs.

Section 3, General Design Considerations, provides an introduction to the major design considerations associated with vegetative biofilters. These include:

- < design flow volumes and rates
- < flow regulation
- < pretreatment
- < protection of the biofilter system
- < suitability and selection considerations
- < filter bed and filter media
- < vegetation
- < inspection and maintenance.

Section 4 provides a summary of analytical procedures for computing runoff and pollutant loading parameters. The following elements are addressed:

-
- < runoff volumes and rates
 - < loading calculations for sediment and nutrients
 - < example problems of runoff and loading.

Vegetated filter strips (VFS) are described in Section 5. The factors that affect filter strip performance are described, including: flow rate and drainage area, development conditions, soils and infiltration rate, topography, depth of water table, and vegetation and climate. Pollutant removal capability and performance are summarized. Design guidance and procedures provided include: sizing procedures, width, level spreader, pervious berm and vegetation. Construction and maintenance requirements are summarized, and cost considerations are described.

Section 6 describes design guidelines and considerations for grass swales. Site considerations and pollutant removal capability is described. The design guidance includes: peak flow rate, slope, shape, width, cross-sectional area, velocity, length, location and vegetative cover. In addition, swale enhancements, e.g., check dams are described. Design guidance and procedures are described and maintenance and costs considerations are provided. A number of design examples are also presented.

The bioretention cell BMP is described in Section 7. The major systems components are introduced and guidance provided include: inflow methods, pretreatment, shallow ponding area, surface mulch layer, planting soil bed, planting materials, sand bed, gravel under drain system and overflow system.

A number of selected appendices supplement the guidance material provided in sections 2 thru 7. These include the following materials:

- < construction specifications for vegetative biofilters
- < landscaping guidelines for vegetative biofilters
- < testing for infiltration, bioretention and sand filter subsoils.

Section Two Vegetated Biofilter Types

Overview

Three different types of vegetated biofilter BMP types have been identified and are described in this section. A brief introduction to each BMP is provided below. Detailed design guidelines are provided in sections 3 thru 7.

Grass Swales

Grass swales have traditionally been used as a low cost stormwater conveyance practice, called grassed waterways, in low-to-medium density residential developments (e.g., half-acre lots). Most public works agencies throughout the U.S. have a typical rural road section standard that allows the use of grass swales within the public right of way. During the early years of SWM technology the focus was on peak discharge control and grass swales were not given much consideration (Ree, 1949, Chow, 1959 and Temple, 1987). As the focus of SWM programs expanded to include water quality considerations and pollutant reduction, the grassed swale has been perceived to represent a potentially important element of the treatment train approach to total SWM (Yousef et al., 1985, and Yu, 1992 and 1993).

It is now generally recognized that vegetated grass swales have a number of desirable attributes with respect to total SWM (MDE, 2000, ASCE, 1998, CRC, 1996 and Yu, 1993). These attributes include:

- slower flow velocities than pipe systems that result in longer times of concentration and corresponding reduction of peak discharges
- ability to disconnect directly connected impervious surfaces, such as driveways and roadways, thus reducing the computed runoff curve number (**CN**) and peak discharge (See Section 3)
- filtering of pollutants by grass media
- infiltration of runoff into the soil profile, thus reducing peak discharges and providing additional pollutant removal
- uptake of pollutants by plant roots (phytoremediation)

Figure 2-1 provides a representative typical section, including both a cross-section and plan view of a grass swale.

Dry Swale with Filter Media

The dry swale consists of an open channel that has been modified to enhance its water quality treatment capability by adding a filtering medium consisting of a soil bed with an underdrain system (CRC, 1996). The dry swale is designed to temporarily store the design water quality volume (V_{WQ}) and allow it to percolate through the treatment medium. The system is designed to drain down between storm events within approximately one day. The water quality treatment mechanisms are similar to bioretention practices except that the pollutant uptake is likely to be more limited since only a grass cover crop is available for nutrient uptake. Figure 2-2 illustrates the design components of the dry swale with filter media (MDE, 2000).

Wet Swales

The wet swale also consists of a broad open channel capable of temporarily storing the V_{wq} but does not have an underlying filtering bed (CRC, 1996). The wet swale is constructed directly within existing soils and may or may not intercept the water table. Like the dry swale, the V_{wq} within the wet swale should be stored for approximately 24 hours. The wet swale has water quality treatment mechanisms similar to stormwater wetlands, which rely primarily on settling of suspended solids (SS), adsorption and uptake of pollutants by vegetative root systems. Figure 2-3 illustrates the design components of the wet swale (MDE, 2000).

Vegetative Filter Strips

VFS and buffers are areas of land with vegetative cover that are designed to accept runoff as overland sheet flow from upstream development. They can be constructed, or existing vegetated buffer areas can be used. Dense vegetative cover facilitates sediment attenuation and pollutant removal. Unlike grass swales, VFS are effective only for overland sheet flow and provide little treatment for concentrated flows. Grading and level spreaders can be used to create a uniformly sloping area that distributes the runoff evenly across the filter strip (Haan et al., 1984, Hayes et al., 1984, Barfield and Hayes, 1988 and Dillaha et al., 1989).

Filter strips have been used to treat runoff from roads and highways, roof downspouts, very small parking lots, and pervious surfaces. They can also be used as the “outer zone” of a stream buffer or as pretreatment to a structural practice. VFS are often used as pretreatment for other structural practices, such as infiltration basins and infiltration trenches. This recommendation is consistent with recommendations in the agricultural setting that filter strips are most effective when combined with another practice (Magette et al., 1989). Figure 2-4 illustrates the primary design components of the filter strip (CRC, 1996).

Bioretention

The bioretention concept was originally developed by the Prince George's County (PGC), Maryland, Department of Environmental Resources in the early 1990's as an alternative to traditional BMP structures (Clar et al., 1993 and 1994). Bioretention is a practice that manages and treats stormwater runoff using a conditioned planting soil bed and planting materials to filter runoff stored within a shallow depression. The method combines physical filtering and adsorption with biological processes. The system consists of a flow regulation structure, pretreatment filter strip or grass channel, sand bed, pea gravel overflow curtain drain, shallow ponding area, surface organic layer of mulch, a planting soil bed, plant material, a gravel underdrain system, and an overflow system. Figure 2-5 illustrates these primary design components of the bioretention cell (MDE, 2000).

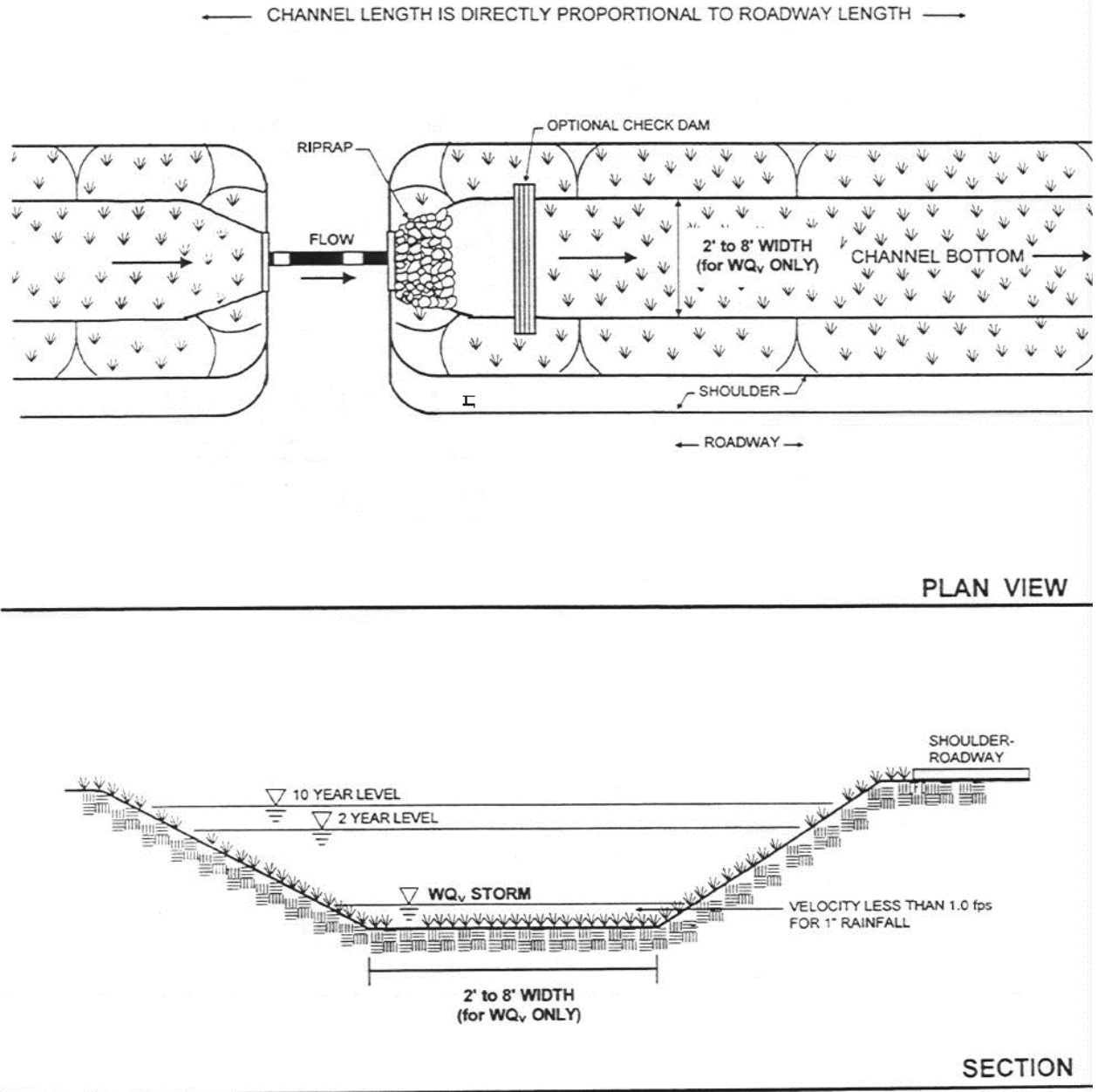
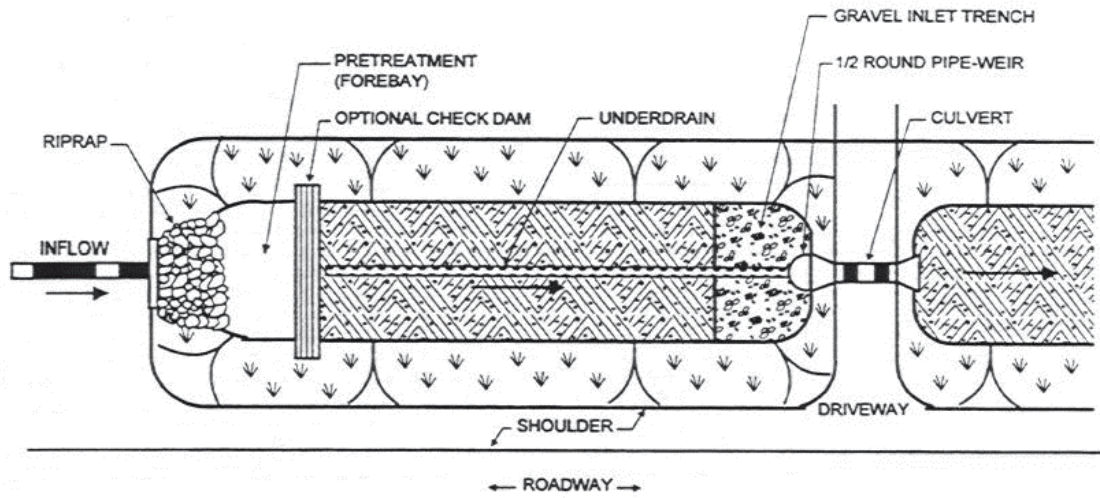
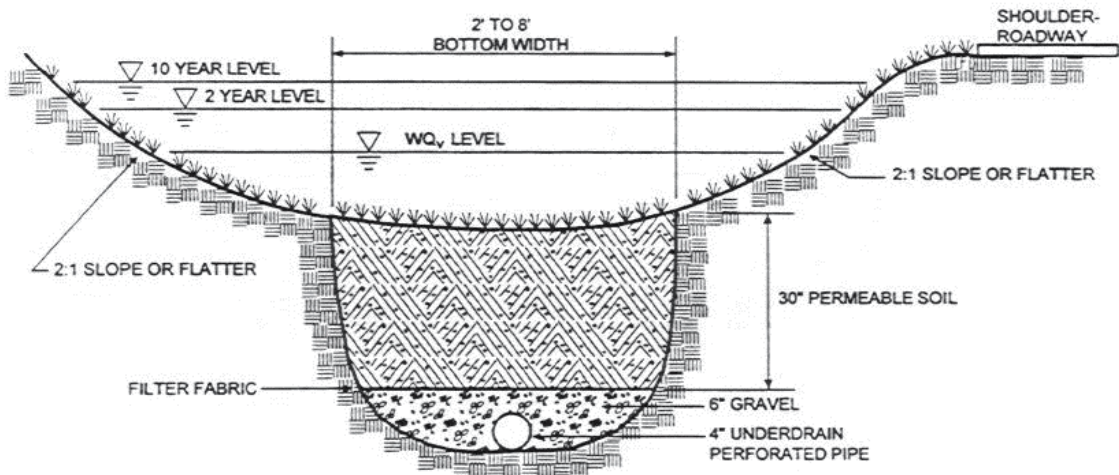

Figure 2-1 Grass Swale (MDE, 2000)



PLAN VIEW



SECTION

Figure 2-2 Dry Swale with Filter Media (MDE, 2000)

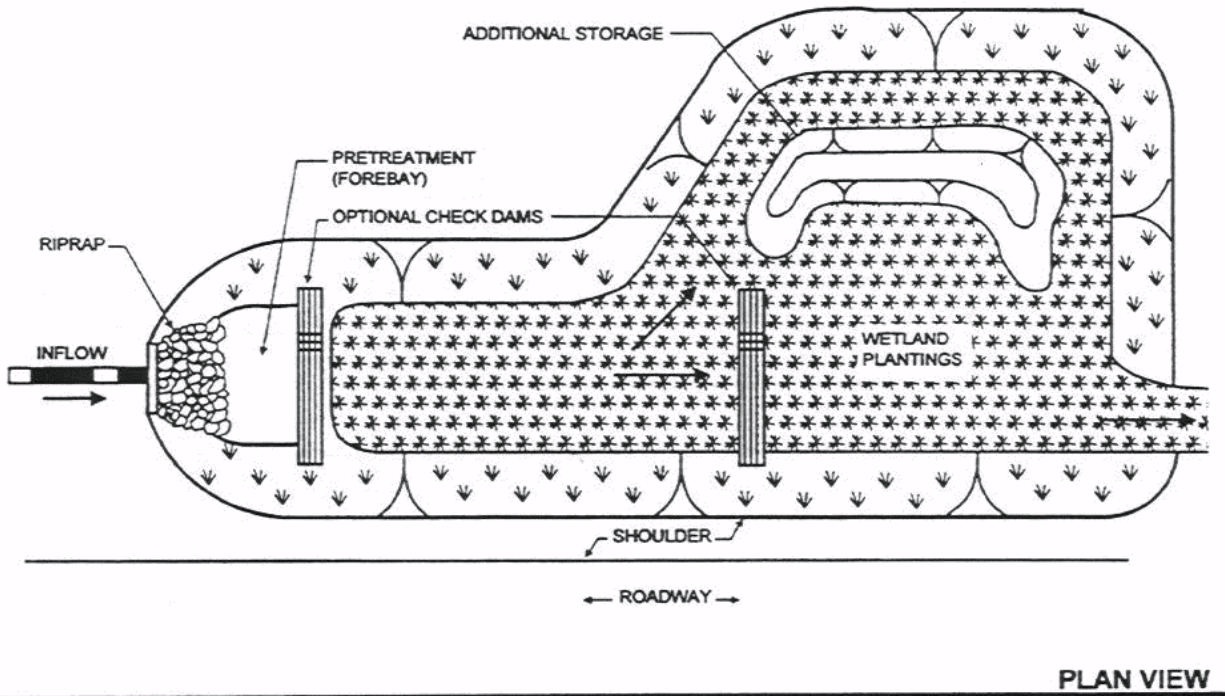

PLAN VIEW

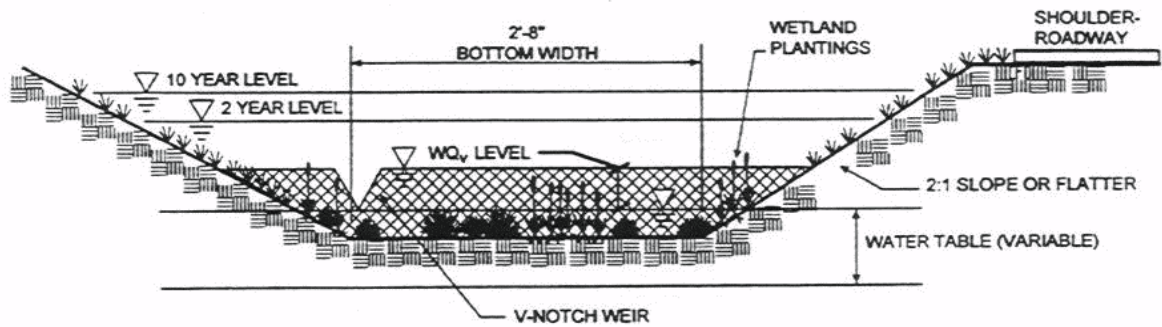

PROFILE

Figure 2-3 Wet Swale (MDE, 2000)

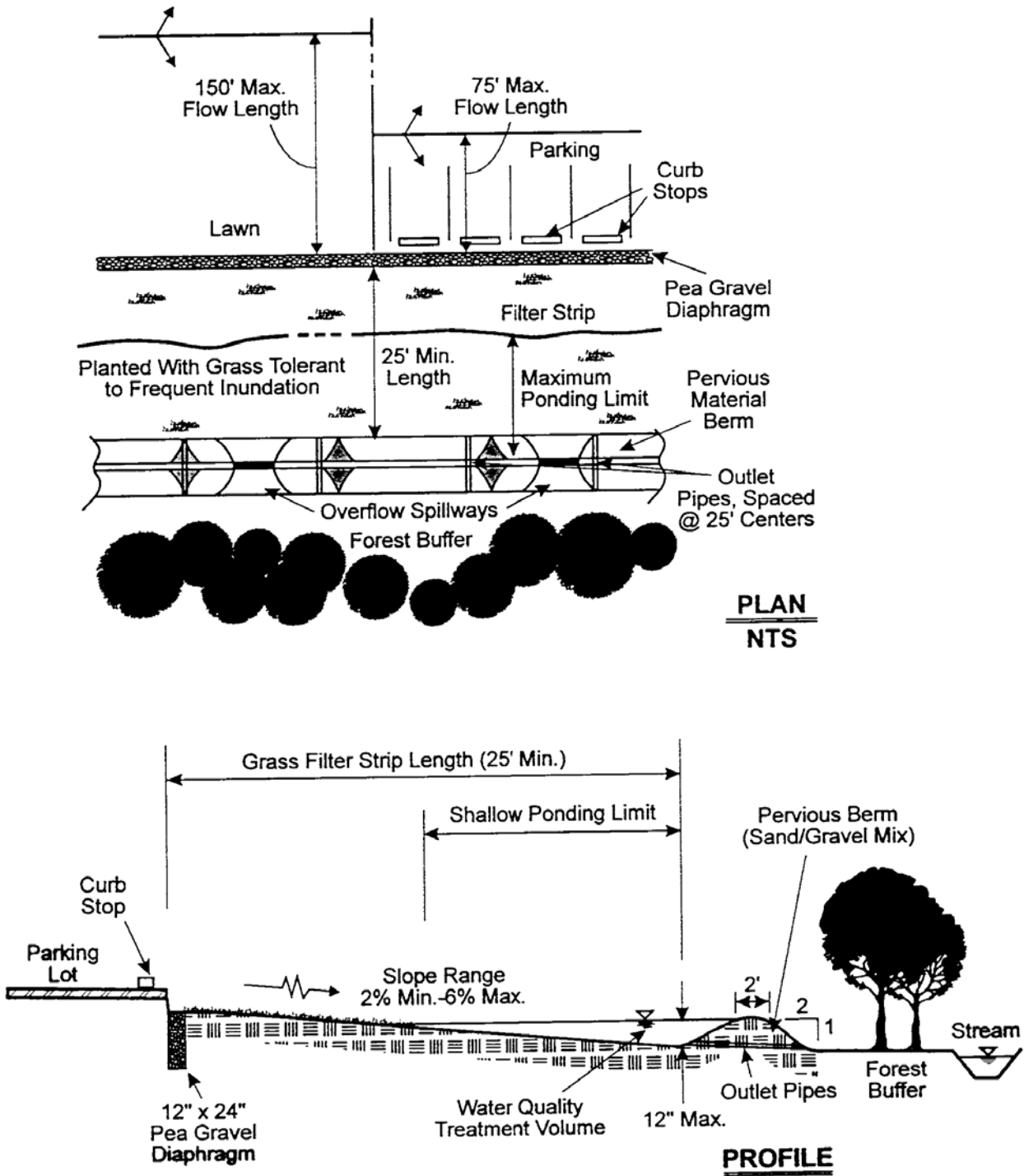

Figure 2-4 Vegetative Filter Strip (CRC, 1996 used with permission)

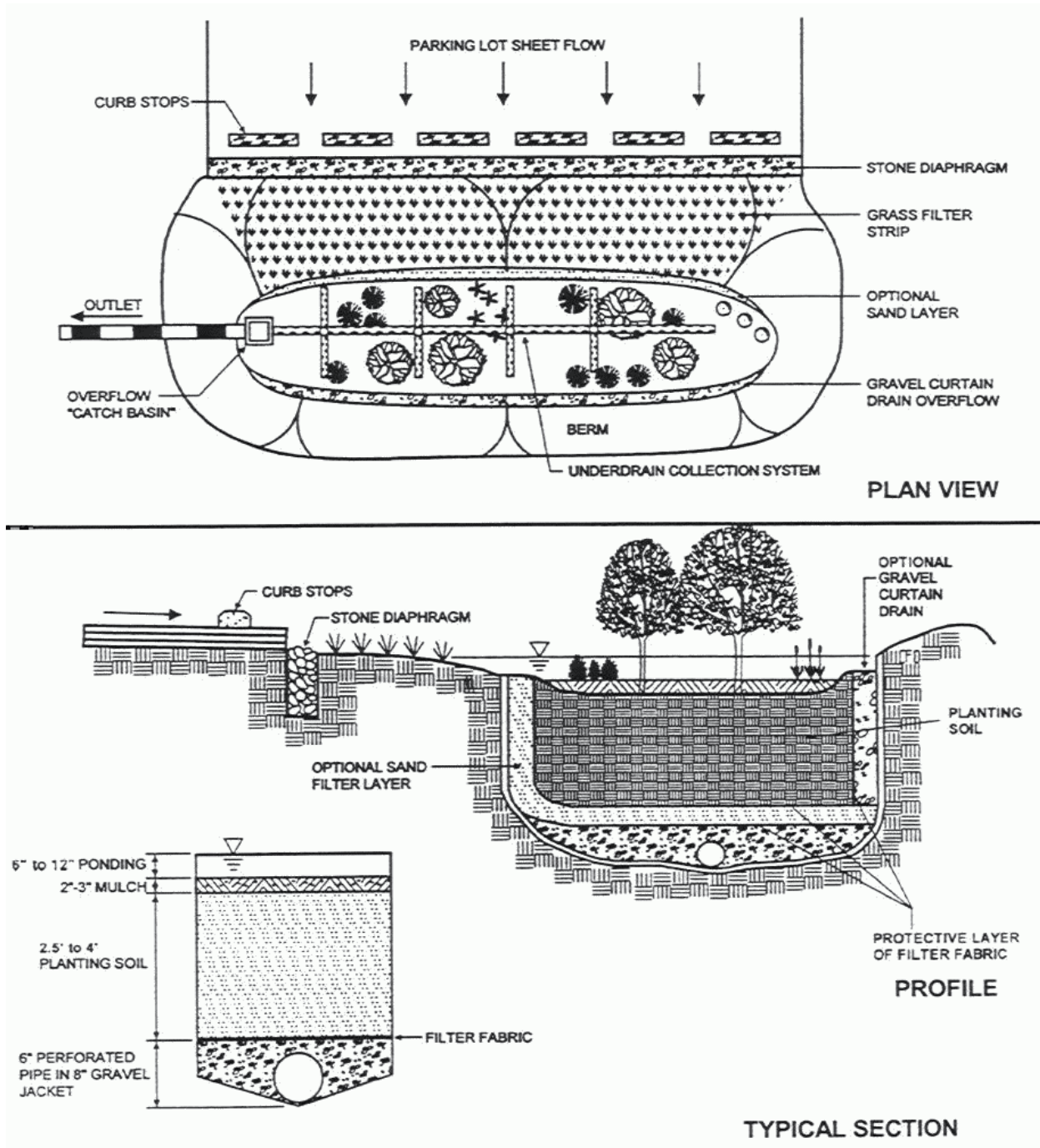

Figure 2-5 Bioretention Cell (MDE, 2000)

Section Three General Design Considerations

Introduction

This section presents some of the current approaches being applied for the design of the vegetative biofilter BMPs described in Section 2. Typical design considerations associated with the use of these vegetative biofilters are presented in this section. These considerations include the following:

Design Flow Volumes and Rates - Identification of the design objectives and computation of design flows associated with these objectives.

Flow Regulation - Approaches to flow regulation, including the volume of flow and the type of control, whether on-line or off-line.

Pretreatment - Pretreatment considerations (including the type of pretreatment to be provided, if any), computational methods and control techniques.

The filter bed and media considerations, vegetation type and inspection and maintenance issues are specific to each biofilter type and provided under the individual discussion of each biofilter type.

Design Flow Volumes and Rates

The design flow volumes and rates are typically determined by the design objectives for the site or project. Design objectives can include: 1) traditional use flow conveyance, 2) water quality control on small sites or in a treatment system approach, 3) reducing the impact of development on the hydrologic regime alterations of a site, 4) addressing groundwater recharge concerns, 5) reducing impacts to stream channel erosion and 6) controlling peak discharge for the 2-, 10- and 100-yr storms.

These various design objectives can have individual or overlapping design volume requirements that affect the design process. A brief description of these design considerations is provided below.

Design to Reduce Hydrologic Regime Alterations

The use of biofilters to reduce hydrologic regime modifications is not new. The hydrologic regime changes associated with land use change, especially land development activities, have been well documented. The creation of impervious areas, in particular hydraulically connected impervious areas, can greatly alter the pre-development rainfall runoff relationships and produce larger volumes of runoff and higher peak discharge rates, as was described in Volume 1.

Vegetative biofilters such as grass swales incorporated into a rural road design can be used to replace a traditional curb and gutter road section approach. Grassed swales can be used in some development conditions to reduce the amount of impervious surfaces, as well as to disconnect directly connected impervious surfaces.

The publication "Urban Hydrology for Small Watersheds: TR-55" published by the Natural Resources Conservation

Service (NRCS) of the U.S. Department of Agriculture (USDA, 1986), provides convenient procedures that allow the design engineer to readily calculate the potential reduction in runoff volume achieved by reducing the total volume of impervious area. This procedure uses the well known runoff curve number (**CN**) method. A number of recent publications (PGC, 1997, and EPA, 2000a and 2000b) that describe the Low Impact Development (LID) design approach to stormwater management have documented the use of this approach. An example of how a site can be modified to reduce the **CN** and runoff volumes is provided in Figure 3-1 and documented in example 3-1 (PGC, 1997).

In addition to reducing the total impervious area and the **CN** value, vegetative biofilters can also be used to effectively disconnect directly connected impervious areas. An impervious area is considered connected if runoff from it flows directly into the drainage system. It is also considered connected if runoff from it occurs as concentrated shallow flow that runs over a pervious area and then into the drainage system (USDA, 1986). The disconnection of impervious areas by means of pervious areas such as grass swales, filter strips and bioretention systems can further reduce the **CN** value and the corresponding runoff volume.

While the NRCS computational procedures have been available for some time, few design engineers are familiar with application of the methods or make frequent use of the techniques. However, as documented in the previously cited publications as well as the recently published Maryland Stormwater Design Manual (MDE, 2000), these techniques can be used on many sites to produce better site design and reduce both the design runoff volume and the peak discharge rates.

The NRCS **CN** computational procedure is described in greater detail in the TR-55 publications and is not reproduced here. The method also relies on graphs and credits designs that limit impervious area to 30% with a lower **CN** value. The computational example presented below is derived from EPA (2000b) and takes into account credits for impervious area below 30% and disconnected impervious area.

Example Computation for Modified **CN**

The following example demonstrates how to compute **CN** for the set of conditions listed below and as shown in Figure 3-1.

Given:

Assume the site, a 1-acre residential lot, is totally wooded and HSG (hydrologic soil group) is a B. This yields a pre-development **CN** value of 55 (TR-55 Table 2-2c, USDA, 1986). The **CN** for a residential 1 acre lot is 68 (TR-55 Table 2-2a, USDA, 1986).

Custom **CN**:

Calculate the **CN** for individual land covers. Assume the traditional connected impervious development with 20% has a **CN** of 98 and 80% open space in good condition with a **CN** of 61 (TR-55 Table 2-2a, USDA, 1986). Assume 25% of the site will be used for reforestation/landscaping (see Figure 3-1) HSG B.

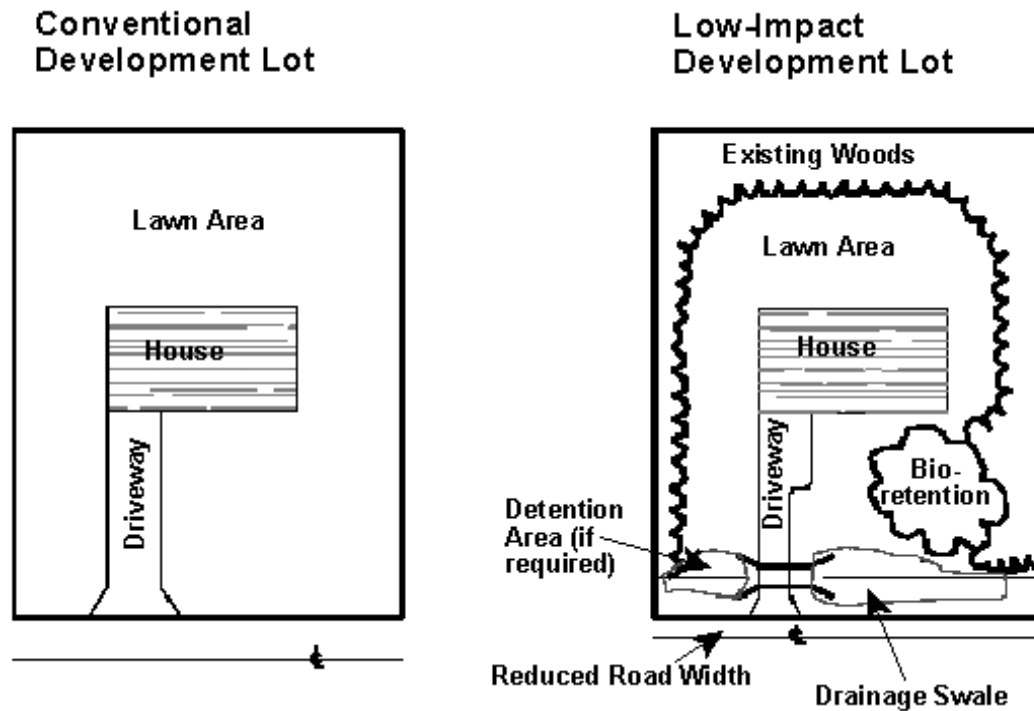

Figure 3-1 Comparison of Land Cover for Conventional and Low Impact Development (modified after P.G. Co., 1997)

Procedure:

Step 1:

Determine percentage of each land cover occurring on site and the **CN** associated with each land cover.

Land Use	HSG	CN	Percent of Site (%)	Land Coverage (ft ²)
Impervious (Directly Connected)	B	96	5	2,178
Impervious (Unconnected)	B	98	10	4,356
Open Space (Good Condition, Graded)	B	61	60	26,136
Woods (Fair Condition)	B	55	25	10,890

Step 2:

Calculate composite custom **CN** (using Equation 3-1):

$$CN_c = \left[\frac{(CN_1 A_1 + CN_2 A_2 + \dots + CN_i A_i)}{(A_1 + A_2 + \dots + A_i)} \right] \quad (3-1)$$

where: CN_c = composite curve number,
 A_j = area of each land cover, and
 CN_j = curve number for each land cover.

$$CN_c = \left[\frac{(98 \times 4,356 + 98 \times 2,178 + 61 \times 26,136 + 55 \times 10,890)}{43,450} \right] = 65$$

Step 3:

Calculate custom CN based on the connectivity of the site imperviousness (using Equations 3-2). TR-55 incorporates additional reduction to the CN value for sites that have disconnected based on the fraction of impervious to pervious area (refer to TR-55 for more complete details for this allowance):

$$CN_c = CN_p + (P_{imp} / 100) \times (98 - CN_p) \times (1 - 0.5R) \quad (3-2)$$

where: R = ratio of unconnected impervious area to total impervious area,
 CN_c = composite curve number,
 CN_p = composite pervious CN , and
 P_{imp} = percent of impervious site area.

Calculating values:

$$CN_p = (61 \times 26,136) + (55 \times 10,890) / 37,026 = 59.2$$

$$R = 10/15 = 0.67$$

$$CN_c = 59.2 + (15 / 100) \times (98 - 59.2) \times (1 - 0.5 \times 0.67) = 63.1 \text{ (use 63)}$$

LID custom CN of 63 is less than NRCS Table value of 68 and is also less than the CN_c of 65 (predevelopment CN is 55).

The example demonstrates that even small changes in site planning by incorporating disconnected impervious area and retaining pervious area may have a profound impact on the potential runoff. Calculation of lower CN values based on 30% area or less unconnected impervious area should be used judiciously. The intent of this exercise should not be to increase lot sizes to achieve the 30% threshold but to achieve the 30% threshold by promoting disconnection and by reducing impervious areas.

Also, as mentioned in Volume 1, cleared and graded sites erode, are often severely compacted, and can no longer prevent rainfall from being rapidly converted into stormwater runoff. Disturbance of a soil profile can significantly change its infiltration characteristics and with urbanization, native soil profiles may be mixed or removed, or fill material from other areas may be introduced (USDA, 1986). Infiltration values of published soil maps and most available models for typical urban soils ignore compaction (Pitt et al., 2000) and therefore pervious effects may be overstated.

The TR-55 procedure was developed for the 2-yr storm or greater. The limitations of this approach for smaller storms are discussed in Appendix B Small Storm Hydrology of Volume 1.

Design to Provide Water Quality Management

Currently the great majority of local jurisdictions simply require that BMPs be sized to provide peak discharge control of the 2-, 10- and 100-yr storms, and assume that this approach provides an adequate level of water quality management. As discussed in Section 3 of Volume 1, this is the current basic requirement under the NPDES Phase 1 and Phase 2 permit programs.

There is an increasing body of knowledge available relating to the design of vegetative biofilters to provide water quality management by reducing the discharge of pollutants to receiving waters. In general three basic approaches are available for use. These include:

- giving a credit for the use of a biofilter such as a grass swale or filter strip
- designing the biofilter BMP to treat a specific runoff volume such as the first ½ or 1 in. of runoff
- using mathematical models including statistical methods and continuous simulation modeling for an actual or representative rainfall record to estimate the long term BMP removal performance.

Water Quality Credits

Maryland's Unified Sizing Criteria (MDE, 2000), as discussed in Section 4 of Volume 1, uses SWM credits. These credits emphasize better site planning techniques, to preclude, reduce and/or minimize the hydrologic and water quality impacts associated with new development activities. Measures may include conserving natural areas, reducing directly connected impervious areas (as defined above), and use of buffer strips and swales. These credits allow engineers to incorporate the broader concepts of Low impact Development (LID) and groundwater recharge within a site design and reduce BMP size, i.e., more traditional pond and swales.

Design Water Quality Volume

Vegetative biofilters can be sized based on the volume of runoff to be treated. As summarized in Section 4 of Volume 1, many local jurisdictions are designing BMPs to capture and treat the runoff volume from small storms, ranging from the first ½ to 1 in. of runoff (measured in watershed inches). Typically these small storm events are related to some percentage of the total annual rainfall/runoff volume. These estimates range from 70% of the total annual runoff volume for the ½ in. storm event to 90% of the total annual runoff volume for the 1-in. storm event. Appendix B in Volume 1 described the procedure developed by Guo and Urbonas (1987) to determine the appropriate storm size for a given area.

A number of States in the Mid-Atlantic region, including Maryland (MDE, 2000), have adopted a target rainfall event for estimating the design Water Quality Volume (V_{wq}) for sizing vegetative biofilters. This event targets capturing 90% of the annual runoff volume (90% rule) and is based on the data reported in the literature (Driscoll, 1987, Guo and Urbonas, 1995 and Urbonas et al., 1990). For the Mid-Atlantic region and much of the Chesapeake Bay Watershed, this corresponds to a rainfall value of 1.0 in. This value will vary for different climatic conditions.

Some jurisdictions are currently using other sizing guidelines, such as the capture and treatment of the first ½ in. of runoff. This criteria may be acceptable for lower impervious areas but will have decreased pollutant capture efficiencies for a higher impervious areas and a lower capture percentage of the annual runoff volume. In addition, several biofilter BMPs are ideally suited to retrofitting applications where full storage is often constrained. Designers and regulators should recognize that the 90% rule is targeted mainly at new construction and is based on maximizing pollutant load capture. Practices sized for smaller treatment volumes can be acceptable in many situations.

Several water quality volume procedures are described. Two simple methods, the Short Cut Method and Small Storm Hydrology, can be utilized to estimate V_{wq} . Both rely on computing a volumetric runoff coefficient (Rv) and multiplying this by the rainfall volume to obtain a runoff volume in watershed inches. Hydrologic models can also be used, as described below.

Runoff Coefficient Approach to Runoff Volume

One approach to runoff prediction is to use a runoff coefficient as a unifying theme for impacts of urbanization on runoff (Schueler, 1987, Schueler et al., 1991 and Booth and Reinelt, 1993). Typical components of imperviousness are roof areas, roads and parking lots. Increased runoff is an obvious result of imperviousness. The runoff coefficient is given by:

$$R_v = a + bl \quad (3-3)$$

where: R_v = the runoff coefficient,
 l = percent impervious, and
 a, b = coefficients.

The first coefficient, a , is considered to be the runoff coefficient for pervious areas. Values typically used are $a = 0.05$ and $b = 0.009$. The relationship is shown graphically in Volume 1 Figure 2-3, along with the data utilized to develop the coefficients (Driscoll et al., 1986).

The Short Cut Method utilizes equation 3-3 to estimate the volumetric runoff coefficient, R_v , (Schueler, 1987). It is recommended that the Short Cut Method be utilized where the site consists of predominately one type of land surface or for quick calculations to obtain a reasonably accurate estimate of treatment volume.

Therefore, the required treatment volume for a site will be equal to:

$$V_{wq} = PR_v \quad (3-4)$$

where: P = rainfall, in in., and
 V_{wq} = water quality volume, in watershed in.

Example 3-2: Water Quality Volume Computation

Assume a 3.0 acre shopping center which is 87% impervious, for a 1.0 inch rainfall event. Using equation 3-3:

$$R_v = 0.05 + 0.009 \times 87 = 0.83$$

and for $P = 1.0$ in.:

$$V_{wq} = (1.00)(0.83) = 0.83 \text{ watershed inches}$$

$$V_{wq} = 0.83 \text{ in. } (1 \text{ ft} / 12 \text{ in.})(3.0 \text{ acre})(43,560 \text{ ft}^2/\text{ac}) = 9,040 \text{ ft}^3.$$

The Small Storm Hydrology Method

The second method, or Small Storm Hydrology Method utilizes the work done by Pitt (1994) and others, to compute a volumetric runoff coefficient (R_v) based on the specific characteristics of the pervious and impervious surfaces of the drainage catchment. This method presents a relatively simple relationship between rainfall amount, land surface and runoff volume. This method is summarized in Appendix B of Volume 1.

Appendix B of Volume 1 provided a brief summary of small storm hydrology. Besides the Urbonas et al. (1990) approach, a brief discussion of the ASCE/WEF (1998) design approach was also presented. In addition to this approach there are other small storm hydrologic models in various stages of development. These include, but are not limited to, the IDEAL model (Hayes and Barfield, 2000); and the Unified Stormwater Treatment (USTM) model (Wong et al., 2001). The IDEAL model is described in further detail starting in Section 4 of this document.

Peak Discharge Rate

The peak rate of discharge is needed for the sizing of off-line diversion structures and to design grass swales. Conventional NRCS methods underestimate the volume and rate of runoff for rainfall events less than 2 in. This discrepancy in estimating runoff and discharge rates can lead to situations where a significant amount of runoff bypasses the filtering treatment practice due to an inadequately sized diversion structure, or leads to the design of undersized grass channels.

A procedure that can be used to estimate peak discharges for small storm events, was developed by Pitt (1994) that relies on the volume of runoff computed using the Small Storm Hydrology Method and utilizes NRCS, TR-55 Graphical Peak Discharge Method. This procedure has been documented (MDE, 2000) and is also incorporated into Appendix B of Volume 1.

Hydrologic Models

The third approach for the design of BMPs for water quality management consists of using hydrologic models to conduct long term continuous simulation using either actual or representative rainfall data to obtain long term BMP performance. This procedure has not been commonly used by local jurisdictions for the design of individual BMPs because of the perceived increase to time and cost. However, these methods are becoming simpler and are commonly encountered in research applications at universities or governmental agencies. As discussed in greater detail in Volume 1, models are essential in the performance of watershed level analysis. Appendix A of Volume 2 provided a brief summary of some of the models available

Design to Maintain Groundwater Recharge Rate

Groundwater recharge criteria have been developed (MDE, 2000) to maintain existing groundwater recharge rates at development sites. This helps to preserve existing water table elevations, thereby maintaining the hydrology of streams and wetlands during dry weather. The volume of recharge (V_{re}) that occurs on a site depends on slope, soil type, vegetative cover, precipitation and evapo-transpiration. Sites with natural ground cover such as forest and meadow have higher recharge rates, less runoff, and greater transpiration losses under most conditions. Because development increases impervious surfaces, a net decrease in recharge rates is inevitable. The use of vegetative biofilters to help maintain groundwater recharge is a relatively new design objective and there is not much data available on the success of this approach. An approach to meet this objective is included in the Maryland 2000 SWM Design Manual (MDE, 2000) and was summarized in Appendix C of Volume 1.

Flow Regulation

The vegetative biofilters are all primarily in-line stormwater treatment practices. Typically used as the first stage of the treatment train, their purpose is to address groundwater and water quality control for small headwater areas. The grass channels, as well as dry and wet swales can receive runoff from concentrated sources (pipe outfalls), as well as from lateral sheet flow along the length of the practice. The isolation/diversion structure within the drainage network, is the preferred method for diverting concentrated flows, prior to entering these treatment practices.

The filter strip, which receives runoff through sheet flow from impervious or pervious surfaces is most commonly designed as an on-line practice. It may be possible, through site grading and other design techniques, to provide an overflow diversion that bypasses larger flows around the facility. However, since the filter strip drainage area is limited by the flow path, the volume of high flow runoff will not generally be excessive and there should be little need to design the system as an off-line practice.

The bioretention cell can receive runoff through sheet flow from impervious or pervious surfaces and is generally also designed as an on-line practice. It may also be used as a side channel treatment device by diverting the smaller frequent flows from the channel to the treatment facility.

Pretreatment

Pretreatment can be provided to extend the practice's functional life, as well as to increase the pollutant removal capability. However pretreatment is not as crucial for this group of practices as with other larger structural BMPs or filter practices. The vegetative element incorporated in the design of vegetative biofilters helps to maintain the infiltration capacity of the soil/media elements. Also since the control areas are relatively small, the annual loadings of sediment or other solids and floatables tend to be correspondingly small.

Nominal pretreatment can usually be incorporated as a component of the system design. The difference with these practices from other filtering practices is that the pretreatment component is more qualitative in nature and is an integral part of the practice itself (e.g., the side slopes of the grass channel). The design components for pretreatment that are specific to the four design variations are presented in Table 3-1. With the exception of sizing a forebay at the initial inflow point, there are no specific, quantitative sizing criteria for these pretreatment components.

Table 3-1 Pretreatment Components for Vegetative Biofilter Practices

Vegetative Biofilter Practice	Pretreatment Practice
Grass Channel, Dry Swale and Wet Swale	<p>A shallow forebay can be provided at the initial point of the channel. The volume of this forebay should be equal to approximately 0.05 in. per impervious acre of drainage.</p> <p>A pea gravel diaphragm can be used along the top of the channel to provide pretreatment for lateral flows entering the practice.</p> <p>Mild side slopes (< or = 3:1) provide additional pretreatment for lateral flows.</p>
Vegetative Filter Strip	<p>A pea gravel diaphragm is recommended along top of the slope to prevent flow concentration.</p> <p>The uphill area, above the shallow ponding limit provides additional pretreatment.</p>
Bioretention	<p>A pea gravel diaphragm is recommended along the top of slope to prevent flow.</p>

Protection of Biofilter System

The successful swale system is dependent on good stormwater treatment throughout its watershed. Good management practices reduce the peak rate of runoff and the volume of water to be carried, percolated, or filtered by the waterway. The swale should be protected by using a combination of the following steps, depending on what best fits the needs of the site:

- construct the waterway in advance of any other channels or facilities that will discharge into it
- divert all flow from the waterway during the establishment period
- establish the vegetative cover according to recommended techniques:
 - % protect the channel seeding with mulch (manure, stubble, straw, jute netting, or wired and staked mulch)
 - % sod the channel
 - % use a portable or temporary sprinkler line to irrigate the new seeding or sodding to ensure and hasten establishment
- reduce the required capacity by dividing the runoff between two or more when needed
- use stable natural topographic conveyances where possible
- maintain vegetative cover by mowing and performing other maintenance work as needed.

The most satisfactory location for a waterway is in a well vegetated natural draw. These locations should be used where possible since they have one or more of the following advantages:

- flattest grade in the immediate area
- most stable channel conditions
- soil and moisture conditions most favorable to vegetative growth
- usually are available for immediate use
- sufficient depth for outlet diversions, terraces or other treatment facilities at grade.

The natural waterway into which the draw flows may need to be shaped, enlarged and stabilized to accommodate the increased flow delivered to it.

Receiving Waterway

A survey should be completed to provide data to enable the designer to determine the adequacy of the outlet or receiving stream into which the waterway discharges. Information should include the slope and cross-sectional area of the receiving channel and notes of the following:

- irregularities of the channel cross-section (i .e., lack of uniformity)
- obstructions
- vegetation
- meandering.

Adjustments should be made by the designer to account for such situations.

Design to Reduce Stream Channel Erosion

Historically, State and local regulatory agencies have used peak discharge control of the 2-yr storm as a surrogate for downstream channel protection. The technical inadequacy of this approach was summarized in Volume 1, and has been documented in a number of reports (McCuen, 1987) and by field observations (Jones, 1996; Maxted, 1996; Stribling, 2001). As documented in Section 3 of Volume 1, this is still the basic requirement of the CWA, as well as most State and

local programs. Some new initiatives are being undertaken; Maryland's revised approach uses extended detention strategies for the 1-yr storm (MDE, 2000).

The dominant thinking is that vegetative biofilters can manage small storms associated with groundwater recharge and water quality management, but are not suitable for larger storm flows that affect channel stability conditions. However, the introduction of new SWM technologies, such as LID, is demonstrating the ability of biofilters in conjunction with the design approaches to reduce hydrologic flow modifications (described earlier), can manage the full spectrum of design storms, ranging from small frequent storms to the 100-yr storm (P.G. Co., 1997, EPA, 2000a and 2000b, and Clar, 2001). Sometimes biofilter BMPs have to be supplemented with conventional end-of-pipe structural BMPs such as ponds, however, the number and size of ponds is usually reduced. Description of these techniques is beyond the scope of this manual, but the reader is directed to the references provided above.

Suitability and Selection Considerations

This section presents guidance for selecting the most appropriate vegetative biofilter for a particular development site. This information has been condensed in a series of tables that help designers and municipal officials select the most effective stormwater filter for their situation. In addition, vegetative biofilters are compared against other stormwater practices that also could be applied at the site (e.g., ponds, wetlands, infiltration and filter systems). The comparative pollutant removal, feasibility criteria and environmental benefits of the vegetative biofilters are compared to the other BMP practice groups.

Experience indicates that three factors should be considered in selecting the appropriate biofilter. First is the compatibility of the biofilter with the land use type. Second is the compatibility of the biofilter with site conditions such as space consumption, available head, cost or maintenance consideration. Third is the effectiveness of the biofilter design in removing the key pollutants of concern. Usually, by the time all three factors are considered, the filtering options are narrowed down to one or two design options. The engineer can then compare the design criteria for the remaining options and select one based on cost and effectiveness.

Land Use Factors

As a group, vegetative biofilters can be applied to a diverse range of development conditions. However, individual designs are limited to a much narrower range. These common development situations include urban retrofit sites, parking lots, roads and streets, small residential subdivisions and backyard/rooftop drainage. Table 3-2 is a matrix that illustrates the most economical and feasible biofilter designs for each of these five broad categories of development, as well as those that are not applicable.

For example, in urban retrofit settings where space is at a premium, the bioretention cell has proven to be one of the most versatile. In most cases, the space requirements of grass channels, swales and filter strips are so great that they can be eliminated from consideration.

Site Conditions

Table 3-3 compares how each biofilter design rates with respect to a number of site conditions, including: media, water table, drainage area, slope, head and required area.

A third key feasibility factor is the cost of constructing the filtering system, and again, the designs exhibit a wide range. The most expensive designs, based on the cost per impervious acre treated, are the underground sand, organic sand, perimeter sand and gravel filters (design criteria not provided). The dry swale are in the mid-cost range, whereas bioretention, wet swales, filter strips and grass channels are very attractive options from a cost standpoint. It should be noted that the construction cost does not include the price of land. If land costs are significant, the rank-order changes dramatically.

Table 3-2 Land Use and Biofilter Suitability

Land Use	Suitability of Biofilter
Urban Retrofit	Bioretention cell has proven very versatile for use in retrofit conditions. Swales are usually not well suited.
Parking Lots	Bioretention cell is well suited for use in parking lots. Swales may be suitable under certain conditions (space, soils, water table). Filter strips can be effective.
Roads	City streets generally do not provide enough space for any biofilter. Suburban areas, specially large to medium lot subdivisions can accommodate all of the biofilters.
Highway	Highways may accommodate biofilters if sufficient space is available in median or side slopes.
Residential	Low density residential affords opportunities for all biofilter uses. High density residential may offer limited opportunity based on space availability.
Rooftops	Roof drain disconnections to filter strips or bioretention areas are recommended where feasible.

Table 3-3 Physical Site Conditions and Biofilter Suitability (Modified from MDE, 2000)

Biofilter	Media	Water Table Depth	Maximum Drainage Area (acres)	Maximum Slope (%)	Head (ft)	Ratio Size to Drainage Area (%)
Grass Channel	Soil	2 ft	5	6	2	6.5
Dry Swale	Filter Media	2 ft	5	6	3-6	10-20
Wet Swale	Soil	Below Water Table	5	6	1	10-20
Filter Strip	Soil	2 ft	NA	15*	NA	100
Bioretention	Filter Media	2 ft	2	None	5	5.0

Notes: NA = not applicable.
 Media - the key evaluation factors are based on an initial investigation of the USDA HSG at the site. Note that more detailed geotechnical tests are usually required for infiltration feasibility and during design to confirm permeability and other factors.
 Water Table Depth - the minimum depth to the seasonally high water table from the bottom or floor of a BMP.
 Maximum Drainage Area - the recommended maximum drainage area that is considered suitable for the practice. If the drainage area present at a site is slightly greater than the maximum allowable drainage area for a practice, some leeway is permitted or more than one practice can be installed.
 Maximum Slope - the effect of slope on the practice.
 Head - an estimate of the elevation difference needed at a site (from the inflow to the outflow) to allow for gravity operation within the practice.
 Ratio Size to Drainage Area - indicates percentage of total drainage area required for BMP.

Comparative Pollutant Removal Capability

Table 3-4 summarizes the pollutant removal from several studies of biofilter BMPs for the following constituents: TSS, total phosphorus (TP), total nitrogen (TN), Nitrate (NO₃), and other pollutants, e.g., different type of metals. Biofilters have some similarities with respect to performance. For example, all typically report relatively high removal rates of suspended sediment, ranging from 68% for the grass channel to 90% or more for the dry swale and the bioretention cell.

Table 3-4 Estimated Pollutant Removal Capability of Biofilters (%)

Biofilter	TSS	TP	TN	NO ₃	Other/Comments
Grass Swale ¹	68	29	NA	-25	Metals: Cu (42%); Zn (45%) Hydrocarbons: 65 % Bacteria: Negative
Dry Swale ¹	93	83	92	90	Metals: Cu (70%); Zn (86%)
Wet Swale ¹	74	28	40	31	Metals: Cu (11%); Zn (33%)
Filter Strip ²	70	10	30	0	Metals: 40-50 %
Bioretention	86 ³	71 - 90 ^{3,4}	43 ⁴	23 ⁴	Metals: Cu (93%), Pb (99%), Zn (99%); COD 97%; Oil & Grease 67%

NA = not applicable

¹Winer, 2000, ²CRC, 1996, ³Yu, et al., 1999, and ⁴Davis et al., 1998

Some differences have been observed in the comparative ability to remove total phosphorus. The best performers were the dry swale and bioretention cells with removal rates of 83% and 70% respectively. Grass channels, wet swales and filter strips were less reliable, at 10-29 % average removal. Vegetative biofilters display a wide range of total nitrogen removal. The dry swale exhibited a very high removal rate of 92%.

While all biofilter designs showed at least moderate capacity to remove trace metals such as copper, lead and zinc, most of the removed metals were already attached to particles. Designs that showed promise in removing dissolved metals include the dry swale and bioretention cell.

It should be noted that pollutant removal rates and mechanisms rely on processes in a generally aerobic environment, as opposed to an anaerobic environment. Filters that go anaerobic tend to release previously captured phosphorous as iron phosphates break down.

Section Four Analysis Procedures for Runoff and Pollutant Loading

Introduction

This section overviews the fundamental process equations that define the stormwater loading from a watershed, including:

- runoff volume and peak discharge
- erosion and sediment yield
- sediment concentrations
- sediment size distributions
- clay content of eroded sediment
- yield of nutrients.

Using probabilities of varying rainfall amounts, seasons and antecedent moisture conditions, single storm values of loadings and yields from BMPs are predicted and converted to average annual storm values. Specifically, sediment is generated differently for pervious and impervious areas. For pervious areas, the Williams' Modified Universal Soil Loss Equation (MUSLE) is used. For impervious areas, an Event Mean Concentration (EMC) for SS is used. For both areas, particle size distribution and the percent of clay in the sediment is estimated. Total phosphorus and total nitrogen isotherms are utilized to distribute the total concentration of a nutrient between the liquid and adsorbed phase. Example calculations are provided as well.

The fundamental process equations have also been incorporated into a spreadsheet computational aid known as Integrated Design and Assessment for Environmental Loadings (IDEAL). IDEAL is a spreadsheet tool for assessing impact of BMPs on discharge of water, sediment and nutrients into streams draining urban areas. The model predicts effluent loads and concentrations of the above elements coming from the watershed as impacted by vegetative filter strips, dry detention basins and wet detention ponds. Aspects of the capabilities of IDEAL are demonstrated through the use of relevant equations for BMP water quality design and some design examples.

Runoff Volumes and Rates

Single Storm vs. Continuous Simulation vs. Storm Probabilities

Runoff has been calculated in models on a single design storm basis or using a continuous simulation model. Examples of single storm models include the Corps of Engineers Models HEC HMS, and SEDIMOT II and III (Wilson et al., 1982 and Barfield et al., 1996). Examples of the continuous simulation models include the HSPF (Johanson et al., 1982), the EPA SWMM model (Huber and Dickinson, 1988) and the STORM model of the Corps of Engineers (Hydrologic Engineering Center, 1975). More recently, the USDA Water Erosion Prediction Project (WEPP) Model (Lindley et al., 1998, Lane and Nearing, 1989 and Laflen et al., 1991) has been introduced. The single storm model has the advantage of simplicity and is frequently used to design for a specific return period. It does not, however, capture the variety of watershed and BMP responses to both low and high flows that occur. This is particularly important when considering

impacts to stream morphology, pollutant removal and aquatic life.

One alternative to the single storm approach is a continuous simulation model. Rainfall and watershed inputs are typically generated on an hourly or daily basis using historic data or data simulators that generate meteorological data with statistical parameters matching historical data. The WEPP continuous simulation model is an example. These models have the advantage of generating runoff information for a wide variety of storms at a variety of intervals that can be analyzed to determine runoff volumes and rates on a probabilistic basis. The disadvantage of the models is that an extensive database is required to simulate watershed characteristics on a daily basis. Although increasing computational power and GIS type databases reduce this disadvantage significantly, the typical designers of stormwater BMPs will need significant upgrading in capability in order to utilize this information.

An alternative to the continuous simulation approach that was recently developed for the Coastal Carolina Council as the IDEAL Model (Hayes et al., 2001) consists of using a combination of the single storm approach and probability information to calculate desired parameters for an average storm. This is done by calculating runoff and other parameters for a range of storm sizes specific to the given location, and multiplying the results by the probability of the given storm occurring. This is then summed over all the storms and gives the value for an average storm. Since the rainfall-runoff response depends on whether the storm occurs in the growing or dormant season and in a wet, average or dry condition, it is necessary to consider these conditions in calculating average values. With this combination approach a statistical average value can be calculated for each of the parameters of runoff, sediment, pollutant and bacteria loadings based on the distribution of precipitation, season and antecedent moisture condition (AMC). Mathematically, this would be written as:

$$E(X) = \iiint X(P, S_{\text{season}}, A_{MC}) f(P, S_{\text{season}}, A_{MC}) dP, dS_{\text{season}}, dA_{MC} \quad (4-1)$$

where: $X(P, S_{\text{season}}, A_{MC})$ = the quantity being predicted (either runoff volume, peak discharge, sediment, nutrient, or bacteria loading) as a function of P , S_{season} and A_{MC} .
 $E(X)$ = the expected, i.e., average of X ,
 $f(P, S_{\text{season}}, A_{MC})$ = the joint probability distribution of precipitation,
 P = precipitation,
 S_{season} = season of the year, and
 A_{MC} = antecedent moisture condition.

Since joint probability distributions are difficult to define, conditional probability is used, and equation 4-1 becomes:

$$E(X) = \iiint X(P, S_{\text{season}}, A_{MC}) f(A_{MC} | P, S_{\text{season}}) f(S_{\text{season}} | P) f(P) dP dS_{\text{season}} dA_{MC} \quad (4-2)$$

where: $f(A_{MC} | P, S_{\text{season}})$ = the conditional probability distribution of A_{MC} given values of P and S_{season} ,
 $f(S_{\text{season}} | P)$ = the conditional probability of season given a value of precipitation P , and
 $f(P)$ = the probability distribution of precipitation P .

Note: The vertical bar implies conditional probability and separates the variables on the left that are variable and those on the right that are given.

When making actual calculations, the conditional probabilities are discretized and the final relationship is written as:

$$E(X) = \sum_{k=1}^{n_k} \sum_{j=1}^{n_j} \sum_{i=1}^{n_i} p_k(P_k) p_j(S_{\text{season},j,k}) p_i(A_{MC,i,j,k}) \quad (4-3)$$

where: $p_k(P_k)$ = the probability of a given storm having a precipitation level of P_k (n_k possible values),
 $p_j(S_{season,j,k})$ = the probability the given precipitation value, P_k will occur in the season, $S_{season,j}$ (n_j seasons – typically growing and dormant), and
 $p_i(A_{MC,i,j,k})$ = the probability that the given precipitation event value, P_k will occur in season, $S_{season,j}$ and antecedent moisture condition, $A_{MC,i,j,k}$ (n_i values – typically low, medium and high).

Thus, to calculate an expected or average value, it is necessary to determine the probabilities of precipitation, season and AMC.

To use this approach, data must be analyzed for the specific region being evaluated. An example is shown in Table 4-1 for the Charleston, SC airport where probability values were determined for 12 precipitation events (0.25 to 10.5 in.) and for the probability of a storm occurring during one of two seasons (growing and dormant) and one of three AMCs within a given growing season. A subsequent example is given in this section, showing how this method can be used to calculate runoff and pollutant loading.

Table 4-1 Example Precipitation Probability Values (Based on 55 years of data for Charleston, SC Airport) (Hayes et al., 2001)

Storm Number	Sum	0	1	2	3	4	5	6	7	8	9	10	11	12
Precipitation Amount (in.)			0.25	0.75	1.5	2.5	3.5	4.5	5.5	6.5	7.5	8.5	9.5	10.5
Probability of Precipitation Amount $p_k(P_k)$	1.00		0.7892	0.1176	0.0697	0.0148	0.0053	0.0023	0.0005	0.0004	0.0001	0	0.0001	0.0001
Probability of Precipitation Event (%)	100%	57.81	33.29	4.96	2.941	0.626	0.222	0.097	0.02	0.016	0.004	0	0.004	0.004
Season	Growing (average first day of frost spring till first day frost fall)							Dormant (average first day of frost fall till first day frost spring)						
Probability of Season $p_j(S_{season,j,k})$	0.695584							0.304416						
Antecedent Moisture Condition (AMC)	I		II		III		I		II		III			
Total 5 Day Antecedent Rainfall (in.)	<1.4		1.4 - 2.1		2.1		<0.5		0.5 - 1.1		>1.1			
Probability of AMC $p_i(A_{MC,i,j,k})$	0.761905		0.105568		0.132527		0.649396		0.181347		0.169257			

Runoff Coefficient Approach to Runoff Volume

The runoff coefficient was previously described in equation 3.3 (see also Figure 2-3 Volume 1) by the following simple linear relationship:

$$R_v = a + bI \tag{4-4}$$

Using runoff coefficient, R_v , runoff volume is calculated as:

$$Q = R_v P \quad (4-5)$$

where: Q = runoff volume in watershed cm (in.), and
 P = precipitation in cm (in.).

The runoff coefficient, R_v , is proposed to integrate variations in season and antecedent moisture coefficient, $A_{MC, i, j, k}$, is proposed to integrate variations in season and AMC.

NRCS Curve Number Approach to Runoff Volume

The NRCS curve number approach to runoff volume is typically thought of as a method for generating storm runoff for rare events and not for water quality design. As typically utilized with the assumption of average AMCs, this would be appropriate. However, Hayes et al. (2001) showed that the method could be used for water quality calculations if evaluated over varying AMCs, considering the probability of rainfall as shown in equation 4-3.

Runoff volume in cm (in.) or m³ (ac-ft) is the runoff in a given storm. Runoff calculated by the NRCS Curve Number Method (USDA, 1972, 1973,; 1973; and 1986), is:

$$Q = \frac{\left(\frac{P}{Const_1} - 0.2S \right)^2}{\frac{P}{Const_1} + 0.8S} Const_1 \quad (4-6a)$$

where: Q = Runoff in cm (in.),
 $Const_1$ = conversion factor of 2.54 for Q in cm (1.0 for Q in in.),
 P = precipitation amount in cm (in.), and
 S = abstraction potential in in. (English units only)

The initial abstraction, I_a , is related to the abstraction potential by the following empirical relationship:

$$I_a = 0.2S \quad (4-6b)$$

The abstraction potential, **S**, is calculated as:

$$S = \left(\frac{1000}{CN} - 10 \right) \quad (4-7)$$

where: **CN** = NRCS Curve number.

The curve number is an indicator of rainfall abstractions of infiltration and surface storage as affected by land use, HSG, and antecedent moisture. Details on the method and its use are included in Haan et al. (1994).

Land Use and Soil Type Impacts on Curve Number

Values for Curve Number are summarized in tables for varying land uses for HSGs A – D in Haan et al. (1994, Appendix 3C). HSG for most soil series are given in Haan et al. (1994, Appendix 3B) and in NRCS TR-55 (USDA, 1986). Example values are given in Table 4-2.

Antecedent Moisture Impacts on **CN**

The values given in Table 4-2 are for AMC II, which is defined as an average condition. To convert to dry or wet, AMC I and III, the values for AMC II are multiplied by a conversion factor that is dependent on the curve number for AMC II, **CN_{II}**, or:

$$CN_I = \frac{4.2 CN_{II}}{10 - 0.058 CN_{II}} \quad (a)$$

$$CN_{III} = \frac{23 CN_{II}}{10 + 0.13 CN_{II}} \quad (b)$$
(4-8)

Composite Runoff Volume for Disturbed and Undisturbed Areas

Total runoff volume is the sum of the two areas. One must sum on a volume basis, not on watershed cm (in), thus:

$$Q_T = \frac{Q_{Im} A_{Im} + Q_{Pe} A_{Pe}}{A_T} \quad (4-9)$$

where: **Q_T** = total runoff in watershed cm (in.),
A_T = total area in ha (acre),
Q_{Im} = runoff for impervious areas in cm (in.),
A_{Im} = impervious area in ha (acre),
Q_{Pe} = runoff for pervious areas in cm (in.), and
A_{Pe} = pervious areas in ha (acre).

Table 4-2 Runoff Curve Numbers for Urban Areas (after NRCS, 1985, 1986)

Cover Description		Curve Number for Hydrologic Soil Groups			
Cover Type and Hydrologic Condition	% Impervious Area	A	B	C	D
Open space (lawns, parks, golf courses, cemeteries, etc.)					
Poor condition (grass cover <50%)		68	79	86	89
Fair condition (grass cover 50 to 75%)		49	69	79	84
Good condition (grass cover >75%)		39	61	74	80
Impervious areas					
Paved parking lots, roofs and driveways		98	98	98	98
Paved streets: curbs and storm sewers		98	98	98	98
Paved streets: open ditches		83	89	92	93
Gravel streets		76	85	89	91
Dirt streets		72	82	87	89
Urban districts					
Commercial and business	85	89	92	94	95
Industrial	72	81	88	91	93
Residential districts by average lot size					
1/8 acre or less (town houses)	65	77	85	90	92
1/4 acre	38	61	75	83	87
1/3 acre	30	57	72	81	86
1/2 acre	25	54	70	80	85
1 acre	20	51	68	79	84
2 acre	12	46	65	77	82
Lawn of any size with no house	0	39	61	74	80
Newly graded areas (pervious only, no vegetation)		77	86	91	94

Runoff Rates and Peak Discharge

Runoff rates, usually referred to as runoff hydrographs, are calculated by using either kinematic wave theory or unit hydrograph theory to convert runoff volumes to runoff distributed over time (Haan et al., 1994). The value of most interest is peak discharge. For smaller watersheds that typically drain into urban BMPs, peak discharge, q_p in m^3/s (ft^3/s) from a watershed is typically calculated by either the rational equation or a procedure known as NRCS TR-55 method (USDA, 1986) which was developed for urban watersheds as an alternative to the rational equation. Regardless of the units desired for peak discharge, q_p , the following equations (4-10a and 4-10b and Table) must be calculated in the units provided:

$$q_p = q_u A Q F \tag{4-10a}$$

where: q_p = peak discharge in ft^3/s

q_u = unit peak discharge in $\text{ft}^3/(\text{s}\cdot\text{mi}^2\text{-in})$,
 A = is area in mi^2 ,
 Q = is runoff volume in in. given by equation 4-6a, and
 F = is a dimensionless pond factor (see equation 4-12b below).

The peak discharge can be converted to metric units (m^3/s) by multiplying the results above by 0.02832 the conversion from cubic feet to cubic meters.

The unit peak discharge, q_u , is given by:

$$\log(q_u) = C_0 + C_1 \log(t_c) + C_2 \log(t_c)^2 \quad (4-10b)$$

where: C_0, C_1, C_2 = constants dependent on the ratio of $0.2S/P$ (S is from eq. 4-7),
 P = precipitation in in., and
 t_c = time of concentration in hr.

Prediction equations for the constants C_0, C_1 and C_2 are given in Table 4-3. These equations are based on the ratio of I_a/P ($I_a = 0.2S$) in in.; limiting maximum and minimum values of 0.5 and 0.1 should be used as noted in Table 4-3. Tabular values for these constants are given in Haan et al. (1994). The time of concentration, t_c , is the flow time from the most remote hydraulic point to the watershed outlet. Procedures for estimating t_c are given in Haan et al. (1994) and other standard hydrology texts.

Table 4-3 Regression Equations for Coefficients in Equation 4-10b (developed by fitting polynomials to the raw data in TR-55 [NRCS, 1986])

NRCS Type Rainfall	C_0	C_1	C_2
I	$y = 68.032x^4 - 74.693x^3 + 24.925x^2 - 3.9797x + 2.522$	$y = -128.45x^4 + 164.61x^3 - 68.632x^2 + 11.33x - 1.1154$	$y = 11.16x^4 - 26.313x^3 + 16.112x^2 - 2.9774x + 0.0456$
IA	$y = 1.8082x^2 - 2.1304x + 2.2419$	$y = -9.5575x^3 + 8.5705x^2 - 1.6186x - 0.2295$	$y = -1.9089x^2 + 1.5174x - 0.2784$
II	$y = -2.7441x^3 + 0.3121x^2 - 0.212x + 2.5741$	$y = 16.611x^4 - 16.336x^3 + 6.4975x^2 - 1.1783x - 0.5476$	$y = -43.001x^4 + 50.414x^3 - 19.732x^2 + 3.2979x - 0.3426$
III	$y = -2.0346x^2 + 0.489x + 2.4433$	$y = 2.0157x^2 - 0.8351x - 0.4538$	$y = 0.1799x - 0.187$

$Y = C_0, C_1, \text{ or } C_2$

$x = I_a/P$, normally $I_a = 0.2S$; for $I_a/P \geq 0.5$, use $I_a/P = 0.5$; for $I_a/P \leq 0.1$, use $I_a/P = 0.1$
 P in in. only

In the absence of local guidance, a good procedure for estimating t_c is the NRCS sum of the overland flow method, in which t_c is calculated as the sum of the travel times from the point of origin of flow to the watershed outlet, or:

$$t_c = \frac{\sum_i^n \frac{L_i}{V_i}}{3600} \quad (4-11a)$$

where: L_i = length of flow segment m (ft) in segment i,
 V_i = overland flow velocity m/s (ft/s) in segment i, and
 n = number of flow segments.

Overland flow velocity for each segment can be calculated from the equation provided by the NRCS, or:

$$V_i = aS_L^{0.5} \tag{4-11b}$$

where: S_L = slope of the segment in m/m (ft/ft), and
 a = coefficient dependent on land use (given in Table 4-4).

Table 4-4 Coefficient “a” for Overland Flow Equation (adapted from NRCS, 1985 and 1986)

Land Use	Coefficient a
Overland Flow	
Forest with Heavy Ground Litter	2.5
Hay Meadow	2.5
Trash Fallow, Minimum Tillage	5.1
Short Grass	7.0
Straight Row Cultivation	8.6
Bare, Untilled	10.1
Bare, Gravel Covered	15.0
Paved, Smooth	18.0
Paved, Rough	20.3
Concentrated Flow	
Alluvial Fans	10.1
Grassed Waterway	16.1
Small Upland Channels	20.3
Medium Upland Channels	25.0

The swamp factor, F , accounts for impacts of storage in ponds and swampy areas on the peak discharge. A relationship that predicts values for F is:

$$F = \frac{1}{0.000525F_{ps}^3 - 0.0208871F_{ps}^2 + 0.169096F_{ps} + 1} \quad \text{for } F_{ps} \leq 5\% \tag{4-12}$$

where: F_{ps} = the fraction of area covered by ponds or swamps.

For swamp or pond areas greater than 5% (at 5%, $F_{ps} = 0.72$), the pond should be treated separately as a basin.

Peak Rate Factors (PRF)

A recent development in storm water hydrology is the concept of a variable peak rate factor. The NRCS TR-55 equations are based on the assumption that the peak of a unit hydrograph is defined as:

$$q_{puh} = \frac{484A}{t_p} \tag{4-13}$$

where: q_{puh} = peak discharge of the unit hydrograph in ft³/s (to convert q_{puh} to m³/s multiply the results by 0.02832),
 A = area in mi², and

t_p = time to peak in hr of the unit hydrograph.

As with equation 4-10a above, regardless of the units desired for q_{puh} , A is in mi^2 , and t_p is the time to peak in hours of the unit hydrograph determined from the time of concentration of the watershed and the duration of rainfall excess. The database developed to generate the TR-55 equations utilized equation 4-13 to predict peak discharge for the unit hydrograph.

Recent work by a variety of sources indicates that equation 4-13 should be written as:

$$q_{puh} = \frac{(PRF) A}{t_p} \quad (4-14)$$

where the constant of 484 has been replaced with a peak rate factor, PRF .

This PRF depends on several factors including slope, time of concentration and watershed area (Meadows et al., 1991 and Meadows, 1991). The most recent work by Meadows (2000) indicates that PRF can be determined by the land use, if the time of concentration for the watershed is given by the NRCS overland flow method. The proposed PRF s for each land use are given in Table 4-5. Meadows (1991) also developed an alternative to the TR-55 relationships as given in Figure 4-2 (the dimension csm/in refers to $ft^3/(s \cdot mi^2 \cdot in)$ for peak unit hydrograph, q_u). The prediction of the unit peak discharge, q_u^{PRF} in ft^3/s , which must be used for a different PRF in equation 4-10 can be accomplished with:

$$q_u^{PRF} = q_u^{484} C_u^{PRF} \quad (4-15)$$

where C_u^{PRF} is the correction between the unit peak discharge as predicted by TR-55 and the unit peak discharge that accounts for PRF . Figure 4-2 can be used to develop C_u^{PRF} using just the lefthand half, or as a complete alternative to TR-55. C_u^{PRF} is determined as the ratio of q_u^{PRF} to q_u^{484} from Figure 4-2.

Table 4-5 Peak Rate Factors (Meadows, 2000)

Land Use	Peak Rate Factor
Urban	
Open Spaces	250
Single Family	325
Multi Family	375
Commercial	550
Industrial	550
Agricultural	
Forest	180
Pasture	200
Row crop	300

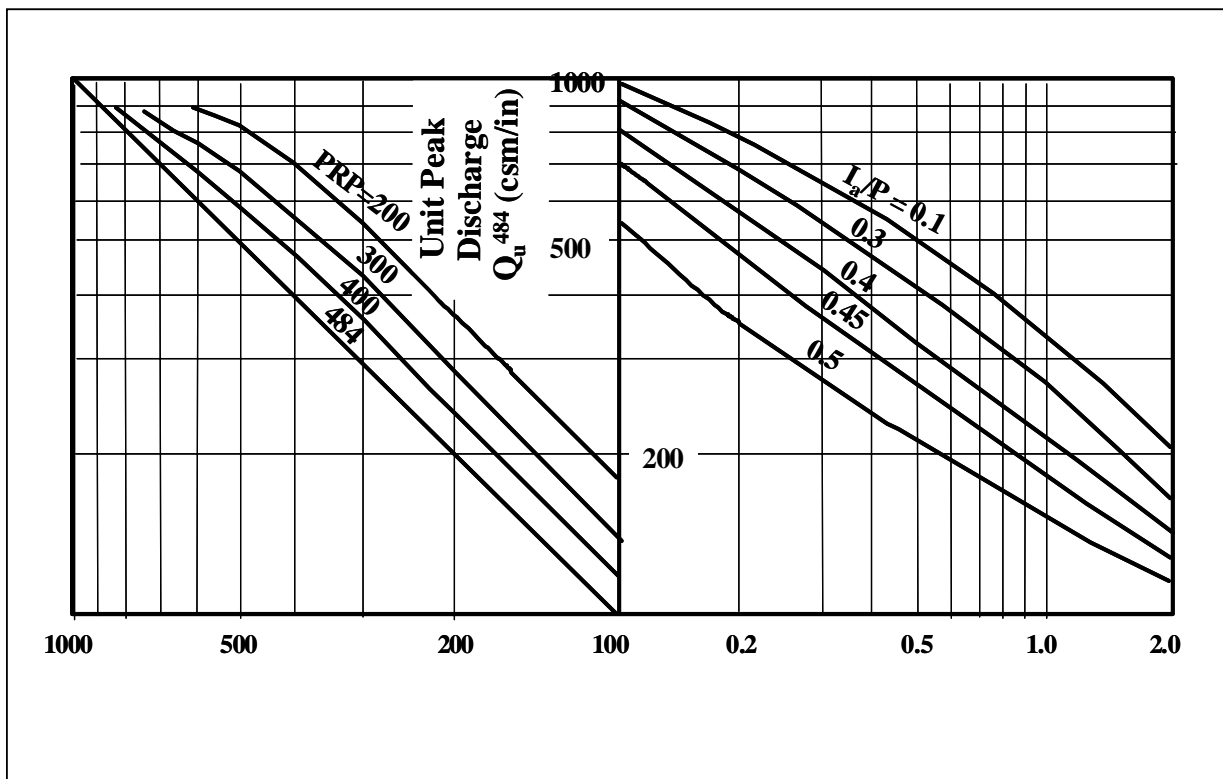

Figure 4-1 Meadows Alternative to TR-55 which takes into Account Peak Rate Factors (Meadows, 1991)

Total Peak Discharge for Disturbed and Undisturbed Areas

The total peak discharge is the sum of the routed discharge from the disturbed and undisturbed areas. Procedures for routing are given in standard hydrology texts such as Haan et al. (1994) and are beyond the scope of this manual. Computer based models for conducting such a routing are numerous, including SWMM (Huber and Dickinson, 1988), SEDIMOT II (Wilson et al., 1982), SEDIMOT III (Barfield et al., 1996), and the US Army Corps of Engineers models HEC-HMS and HEC-RAS. When using spreadsheet or calculator computations, a conservative computation

can be made by assuming that the peak discharges align in time and that there is not significant attenuation of peaks in the channel, or:

$$q_{pT} = q_{pIm} + q_{pPe} \tag{4-16}$$

where: q_{pT} = the peak discharge for the total watershed,
 q_{pIm} = peak discharges for the impervious areas,
 q_{pPe} = peak discharges for the pervious areas, and
the subscripts **T**, **Im** and **Pe** stand for total (or composite), impervious and pervious, respectively.

If the channels are such that flow is modified between the source areas and the reservoir, then q_{pIm} and q_{pPe} need to be routed down the channels, the above models or similar approaches can be used. Use of equation 4-16 in any case, would be conservative.

Loading Calculations for Sediment

Definition of Sediment Load by Locally Collected Empirical Data

The science of calculating sediment yields in urban areas is not highly advanced, as most sediment yield models have been developed for agricultural, forest and range watersheds. Examples of these rural area models include the RUSLE (Renard et al., 1992), MUSLE (Williams and Brandt, 1972), WEPP (Lane and Nearing, 1969), SEDIMOT II (Wilson et al, 1982) and SEDIMOT III (Barfield et al., 1996). Development of an urban model for sediment production would be highly desirable.

However, until such a model is developed, the first recommended approach to sediment yield is to collect data for the specific location from varying land uses. Ideally, the data should be differentiated between the following categories.

1. Residential single family
 - a. guttered
 - b. non-guttered
2. Residential multiple family
 - a. guttered
 - b. non-guttered
3. Commercial
 - a. strip Mall
 - b. mall
 - c. urban centers
4. Industrial

Collection of a database adequate to develop process-based models or statistical models such as the RUSLE or MUSLE would be prohibitively expensive for a given locale, thus the focus of data collection would likely be on EMC. The EMC for sediment should ideally be defined as the expected average concentration in a storm with a defined return period in order to calculate return period or expected average values. Unfortunately, this would be extremely difficult to determine, requiring a long term extensive database. As an alternative, it is defined for sediment as:

$$EMC_{SED} = \frac{Y_{ANNUAL}}{\gamma Q_{ANNUAL}} 10^6 \tag{4-17}$$

where: EMC_{SED} = event mean concentration for sediment in mg/l (ppm),

Y_{ANNUAL} = annual sediment yield in kg (lb),
 γ = the density of water in kg/m³ (specific gravity of water in lb/ft³), and
 Q_{ANNUAL} = annual runoff volume in m³ (ft³).

This yield, Y_{ANNUAL} , is defined by:

$$Y_{ANNUAL} = 10^{-6} \left\{ \sum_{i=1}^n \gamma \int_0^{Dur} q_i(t) C_i(t) dt \right\} \quad (4-18)$$

where: $q_i(t)$ = flow rate in a storm in m³/s (ft³/s),
 $C_i(t)$ = sediment concentration in mg/l (ppm),
 Dur = duration of storm in seconds, and
 n = total number of storms in a year.

The overbar in equations 4-18, 4-19 and 4-20 indicates the average value of a large number of years. Q_{ANNUAL} is given by:

$$Q_{ANNUAL} = \left\{ \sum_{i=1}^n \int_0^{Dur} q_i(t) dt \right\} \quad (4-19)$$

which would be the typical definition of runoff volume. Data collection to determine the values in equations 4-17 through 4-19 would require sampling of all storms at intervals sufficient to define the hydrographs and sediment graphs for each. This would be the preferred method for collecting data.

An alternative to the use of equations 4-17 through 4-19 would be to use one or more discrete simultaneous samples of sediment concentration and flow rate for each storm, taken at times to insure adequate sampling of the peak flow rates and sediment concentrations, and determine EMC_{SED} in mg/l (ppm) from:

$$EMC_{SED} = \frac{\overline{\sum_{i=1}^n q_i C_i}}{\overline{\sum_{i=1}^n q_i}} \quad (4-20)$$

where: n = the number of samples taken in a year.

While collecting the data for EMCs, it will also be desirable to collect data on size distribution or settling velocity distribution of sediment. This information will be needed for predicting trapping in the filter strips and bioswales.

Definition of Sediment Load by Using Models and National Database

When locally collected data is not available a default technique would be to utilize models and EMCs from a national database. For pervious areas, the Williams' Modified Universal Soil Loss Equation (MUSLE) (Williams and Brandt, 1972) is an option for calculating sediment yields. For the impervious areas, an EMC for TSS from a national database such as NURP is recommended. For both areas, it is necessary to develop an estimate of particle size distribution and the percent of clay in the sediment in order to predict trapping in the VFS. For the pervious area, the CREAMS model (A field scale model for Chemicals, Runoff, and Erosion from Agricultural Management Systems, Knisel, 1980) can be used for eroded size distribution and for percent clay. For the impervious areas, the size distribution used is based on data from the National Urban Runoff Program (NURP).

Sediment Yield from Pervious Area – MUSLE

Williams (1977) developed the MUSLE using data from watersheds ranging from 2.7 to 4380 acres. The model predicts sediment yield from the relationship:

$$Y_{Pe} = \text{Const}_2 (Qq_p)^{0.56} \{K\}_a \{LS\}_a \{CP\}_a \quad (4-21)$$

where: Y_{Pe} = the sediment yield from pervious areas in kg (lb),
 Q = is runoff predicted from equation 4-6 *converted* to either m³ or ac-ft, or other suitable method,
 q_p = is peak discharge in m³/s or ft³/s predicted by equation 4-10a, 4-13 or 4-14, or other suitable method,
 $\{K\}_a, \{LS\}_a, \{CP\}_a$ = average USLE erosion parameters for watershed (subscript *a* refers to average), and
 Const_2 = 11,781 kg (1.90 x 10⁵ lb).

Definition of USLE Erosion Parameters

The USLE K factor, is soil erodibility defined for a soil as:

$$K = \frac{2.1 \times 10^{-4} (12 - OM) M^{1.14} + 3.25 (S_1 - 2) + 2.5 (P_1 - 3)}{100} \quad (4-22)$$

where: OM = percentage organic matter,
 P_1 = permeability index,
 S_1 = structure index, and
 M = function of the primary particle size fractions.

The functional relationship for M is given by:

$$M = (\%MS + \%VFS)(100 - \%CL) \quad (4-23)$$

where: $\%MS$ = percent silt sized particles (0.002-0.05 mm),
 $\%VFS$ = percent very fine sand (0.05-0.1 mm), and
 $\%CL$ = percent clay sized particles (less than 0.002 mm).

The length-slope factor, LS , is a dimensionless parameter defined as:

$$LS = \left(\frac{\lambda}{\text{Const}_3 72.6} \right)^{\beta/1+\beta} (10.8 \sin \theta + 0.03); \quad \sin \theta \leq 0.09$$

$$LS = \left(\frac{\lambda}{\text{Const}_3 72.6} \right)^{\beta/1+\beta} (16.8 \sin \theta - 0.50); \quad \sin \theta \geq 0.09$$
(4-24)

where: θ = slope angle in radians,
 λ = the slope length in m (ft),
 β = the slope length coefficient, and
 $\text{Const}_3 = 0.3048$ for λ in m (1.0 for λ in ft).

The slope length coefficient, β , is defined by:

$$\beta = f_r \frac{11.16 \sin \theta}{3.0 (\sin \theta)^{0.8} + 0.56}$$
(4-25)

where: f_r = coefficient for tendency to rill = 0.5 for low tendency to rill; 1.0 for average tendency to rill; or 2.0 for high tendency to rill.

The cover-practice factor, CP , is a dimensionless unit that takes into account the effects of vegetation has on energy reduction of falling rain. Typical values as given in Table 4-6. Detailed and additional values are given for CP in Haan et al. (1994) for a variety of conditions along with a detailed discussion of the equations and relationships for all the erosion parameters.

The concentration of sediment (or alternatively TSS) from pervious areas, $C_{Pe,SED}$ in mg/l is given by:

$$C_{Pe,SED} = \frac{Y_{Pe}}{\gamma Q_{Pe} A_{Pe} \text{Const}_4}$$
(4-26)

where: γ = density of water, 1000 kg/m³, in metric units or specific gravity 62.4 lb/ft³, in English units
 Q_{Pe} = runoff from the pervious area given by equation 4-6 in cm (in.),
 A_{Pe} = watershed area in ha (acre), and
 $\text{Const}_4 = 10^{-4}$ for metric (0.00363 for English units).

Table 4-6 Typical Values for **CP** for Equation 4-25 (Haan et al., 1994).

Cover Description	Typical Value for CP				
	% Cover	CP			
Lawn (height of grass = 0.1 ft)	100	0.01			
	90	0.11			
	80	0.20			
	70	0.31			
	50	0.51			
	% Canopy Cover	Mulch		CP	
		lb/ft ²	% Ground Cover		
Flower Beds (height of flowers = 0.5 ft) $CP = 1 - F_c e^{-0.1H}$ F_c = fraction of canopy cover H = average height of canopy in ft	100	0.02	25	0.015	
		0.05	42	0.009	
		0.10	60	0.004	
		0.20	98	0.001	
	75	0.02	25	0.085	
		0.05	42	0.052	
		0.10	60	0.026	
		0.20	98	0.006	
	50	0.02	25	0.157	
		0.05	42	0.094	
		0.10	60	0.047	
		0.20	98	0.010	
	Shrubs (height = 3 ft)* $CP = (1 - F_c e^{-0.1H})(e^{-4R_c})$ F_c = fraction of canopy cover H = average height of canopy in ft R_c = % Ground Cover/100	100	0.02	25	0.078
			0.05	42	0.023
		0.10	60	0.005	
		0.20	98	0.001	
75		0.02	25	0.013	
		0.05	42	0.080	
		0.10	60	0.040	
		0.20	98	0.009	
50		0.02	25	0.189	
		0.05	42	0.113	
		0.10	60	0.056	
		0.20	98	0.012	

Equations are modifications of equations 8.52 and 8.53 in Haan et al. (1994).

* Design example will use value of 30 ft.

Sediment Yield from Impervious Areas

Sediment yield from impervious areas can be given by EMCs and runoff volume, or:

$$Y_{Im} = \text{Const}_4 \text{EMC}_{SED} \gamma Q_{Im} A_{Im} \quad (4-27)$$

where: Y_{Im} = sediment yield from impervious areas in kg (lb),
 EMC_{SED} = event mean concentration for TSS in mg/l (ppm),
 Q_{Im} = runoff from the impervious area given by equation 4-6 in cm (in.),
 A_{Im} = impervious area in ha (acres), and
 Const_4 = previously defined in equation 4-26.

EMC for the TSS are given in Table 4-7 based on information from NURP (EPA, 1983) as well as other reports. It is highly recommended that EMC values be collected for EMC_{SED} in the areas being analyzed in order to increase the validity of the computations.

Table 4-7 Event Mean Concentrations for TSS

<i>Land Use</i>	<i>EMC_{SED} (mg/l)</i>
Forest	26
Low and medium density residential	117
High density residential, industrial, commercial	116

Total Sediment Yield From Pervious and Impervious Areas

Total yield flowing into a pond, Y_T , is the sum of the sediment coming from the impervious and pervious areas. The simplest approach is to use the sum of the two, or

$$Y_T = Y_{Im} + Y_{Pe} \quad (4-28)$$

Unless the flow occurs in lined drainage channels without deposition, corrections would need to be made for deposition channel erosion. Such correction is beyond the scope of this manual; however, assuming zero deposition would be conservative. The composite concentration would be calculated by using equation 4-26, replacing the sediment yield from impervious areas with yield predicted by equation 4-28 and runoff volume from equation 4-9.

Size Distribution of Sediment

Sediment size distribution should ideally be taken from runoff samples collected over the same storms as those for developing the EMC_{SED} data discussed in the **Sediment Yield from Impervious Areas** sub-section above and summarized separately for each land use class. Using the samples collected, a portion of the sample of sufficient mass should be used for the size distribution determination, using the following procedures.

- Take care in sample preparation not to add any material that would serve as dispersant or flocculant to the sample at any time after its collection. Particles settle as aggregates or primary particles, depending on their natural state in the flow and this aggregation should not be disturbed. In particular, care should be taken not to lower pH.
- Using a particle size analyzer, a settling tube, or a pipette test apparatus, determine the particles size distribution. If a particle size analyzer is used, it should be calibrated against several samples in which a standard pipette test has been conducted.

Details on conducting the analysis are given in Haan et al. (1994).

Eroded Sediment Size Distribution by Modeling

The inflow size distribution is assumed to be the same regardless of the actual treatment BMPs used, therefore the development of model values below can be used for all VFS in this volume, as well as basins in Volume 3.

Pervious Areas

In the absence of local empirical data, eroded size distributions for pervious areas can be defined from the parent matrix material composition/fractions using the CREAMS model (Foster et al., 1985). The CREAMS relationships predict percent primary clay, silt and sand as well as the percent large and small aggregates. Representative diameters for each are also predicted. The relationships were developed from data for Midwestern soils but have been used for soils throughout the country. Until modifications are available, the original equations given in Table 4-8a and b are recommended.

Inputs needed from local soil database for the equations in Table 4-8a and b are fraction original clay O_{cl} , fraction original silt O_{si} and fraction original sand O_{sa} . These three fractions are typically available from the soils database for the NRCS for various types in an area. Local data collection of the percentages is preferred.

Table 4-8a Representative Diameters by Classes Based on Soil Matrix Fractions

Class	Representative Diameter (mm)	Range Limits of Clay in Soil Matrix	Specific Gravity
Primary Clay (cl)	$D_{cl} = 0.002$		2.65
Primary Silt (si)	$D_{si} = 0.010$		2.65
Primary Sand (sa)	$D_{sa} = 0.200$		2.65
Small Aggregate (sg)	$D_{sg} = 0.030$ $D_{sg} = 0.2(O_{cl} - 0.25) + 0.030$ $D_{sg} = 0.100$	$O_{cl} < 0.25$ $0.25 \neq O_{cl} \neq 0.6$ $O_{cl} > 0.60$	1.80
Large Aggregate (lg)	$D_{lg} = 0.30$ $D_{lg} = 2 O_{cl}$	$O_{cl} \neq 0.15$ $O_{cl} > 0.15$	1.60

Impervious Areas

Particle size distributions for material in the impervious areas are based on information from the NURP database, as shown in Table 4-9 (Schueler and Lugbill, 1990). The numbers represent averages from the database and may not be representative of a given site. The averages can be used as a first estimates, but acquisition of local data is highly recommended to improve prediction accuracy of the model.

If it is assumed that all of the sediment from impervious areas is composed of primary particles and was blown in by the wind, or if aggregates did somehow make their way to the impervious areas, they were crushed by vehicle or foot traffic. This would be a conservative assumption in terms of water quality, as aggregates would settle more slowly than primary particles of the same size range. Also, it will be assumed, as discussed later, that there are no clay particles in the silt and sand size range particles since there are no aggregates.

Table 4-8b Fraction of Sediment by Class Based on Soil Matrix Fractions

Class	Fraction of Sediment in Class (mm)	Range Limits of Clay in Soil Matrix
Primary Clay (cl)	$F_{cl} = 0.26 O_{cl}$	
Primary Silt (si)	$F_{si} = O_{si} - F_{sg}$	
Primary Sand (sa)	$F_{sa} = O_{sa} (1 - O_{cl})^{5.0}$	
Small Aggregate (sg)	$F_{sg} = 1.8 O_{cl}$ $F_{sg} = 0.45 - 0.6(O_{cl} - 0.25)$ $F_{sg} = 0.6 O_{cl}$	$O_{cl} < 0.25$ $0.25 \# O_{cl} \# 0.5$ $O_{cl} > 0.50$
Large Aggregate (lg)	$F_{lg} = 1 - F_{cl} - F_{si} - F_{sa} - F_{sg}$	
F_{cl} = Fraction primary clay in eroded sediment F_{si} = Fraction primary silt in eroded sediment. F_{sa} = Fraction sand in eroded sediment F_{sg} = Fraction small aggregate in eroded sediment F_{lg} = Fraction large aggregate in eroded sediment		O_{cl} = Fraction original clay in soil matrix O_{si} = Fraction original silt in soil matrix O_{sa} = Fraction original sand in soil matrix

Predicting Clay Sized Particles

Knowledge of the mass of clay fraction is important to predicting water quality and is therefore a parameter that should be predicted. If local data is being collected as recommended for EMC_{SED} , the fraction of clay in the samples, categorized by land use classes, should be determined during the particle size analysis. In the absence of local data collected, the CREAMS model could be used as a default to predict composition of eroded sediment (Foster et al., 1985). The CREAMS model also contains relationships to predict the fraction of clay on a mass basis for each of the particle classes in Table 4-8b. The relationships are given in Table 4-10. The yield of clay sized particles, Y_{CP} in kg (lb) is given by:

$$Y_{CP} = \sum_{j=1}^2 Y_j \sum_{i=1}^5 F_{ij} CF_{ij} \quad (4-29)$$

where F_{ij} and CF_{ij} are given in Tables 4-8, 4-9 and 4-10 for each particle class i and for each of the two classes of perviousness, j , and Y_j refers to yield from impervious or pervious areas as given by either equation 4-21 or 4-27.

The yield of active clay, Y_{AC} , in kg (lb) is determined by subtracting the settleable solids portion of the nutrients and other chemicals from Y_{CP} , or:

$$Y_{AC} = Y_{CP} - \sum_{k=1}^m Y_{S,k} \quad (4-30)$$

where: $Y_{S,k}$ = settleable yield in kg (lb) of a given chemical pollutant, k
 S = refers to settleable,
 m = the number of chemical pollutants being considered, and
 Y_{AC} = yield of clay-sized particles with an active charge that provides a surface for sorption of pollutants such as nutrients and other chemicals.

Table 4-9 Diameters and Settling Velocities for Sediment (TSS) from Impervious Areas (adapted from Driscoll et al., 1986; Schueler and Lugbill, 1990)

Particle Class	Diameter (mm)	Settling Velocity (ft/hr)	Fraction of Particles
Clay F_{cl}	0.002	0.040	0.26
Silt F_{si}	0.01	1.012	0.55
Sand F_{sa}	0.2	228.9	0.19
Small Aggregates F_{sg}	0.03	NA	0
Large Aggregates F_{lg}	0.3	NA	0

Table 4-10 Fraction of Clay Within Particle Classes in Table 4-8b

Particle Class	Fraction of TSS in Particle Class That is Clay Sized Particles	
	Pervious Areas	Impervious Areas
Clay (CF_{cl})	1	1
Silt (CF_{si})	0	0
Sand (CF_{sa})	0	0
Small Aggregates (CF_{sg})	$O_{cl} / (O_{cl} + O_{si})$	0
Large Aggregates (CF_{lg})	$O_{cl} - F_{cl} - F_{sg}CF_{sg}$	0

Composite Eroded Size Distribution Aggregated and Primary Particles.

The composite yield for impervious and pervious areas for a given size class, $Y_{T,i}$, is given by:

$$Y_{T,i} = F_{Im,i} Y_{Im} + F_{Pe,i} Y_{Pe} \quad (4-31)$$

where: Y_{Im} = impervious sediment yield,
 Y_{Pe} = pervious sediment yield,
 $F_{Im,i}$ = the fraction of impervious sediment in size class i , and
 $F_{Pe,i}$ = the fraction of pervious sediment in size class i .

The composite fraction $F_{T,i}$ within a given size range then becomes:

$$F_{T,i} = F_{Im,i} Y_{Im} / Y_T + F_{Pe,i} Y_{Pe} / Y_T \quad (4-32)$$

Composite Clay Size Particles and Active Clay for Pervious and Impervious Areas.

The composite yield of clay size particles is given by the sum of the two contributing areas, or:

$$Y_{CP,T} = Y_{CP,Im} + Y_{CP,Pe} \quad (4-33)$$

The composite yield of active clay particles is given by:

$$Y_{AC,T} = Y_{AC,Im} + Y_{AC,Pe} \quad (4-34)$$

Example calculations of eroded size distributions and clay fractions are given later in this section.

Loading Calculations for Nutrients and Other Chemicals

Developing Nutrient Loading by Locally Collected Empirical Data

As with sediment yield, the science of calculating nutrient loads in urban areas is not highly advanced, as most nutrient yield models have been developed for agricultural, forest and range watersheds. Examples of these rural area models include the CREAMS model (Knisel, 1980) and HSPF (Johanson, 1984). Development of an urban model for nutrient model would be highly desirable. However, until such a model is developed, the first recommended approach to nutrient loading is to collect data for the specific location from varying land uses.

Nutrients of concern are typically limited to total phosphorus and total nitrogen. Monitoring of nutrient loading should follow the same procedures as for sediment described earlier and utilize the same land use classifications. Once collected, these EMCs can be used with the relationships in the following section to calculate loading.

Developing Nutrient Loading from National Database EMCs

The loading of nutrients for agricultural lands can be calculated from land use, soil information and agricultural practices as done in the CREAMS model (Knisel, 1980 and 1985, and Leonard and Knisel, 1986). The loading functions are based on empirical equations that did not include an urban component, hence the relationships do not extend to urban areas. For urban areas, relationships based on washoff have been proposed, but calibration is necessary for their use and the calibration is difficult and typically yields weak results (Donigian and Huber, 1990). An alternative approach, and one that is recommended in the absence of a more suitable model, is to use EMC defined for different land uses, following Schueler (1987) and Thomson et al. (1997). The EMC is assumed to be distributed among settleable (particulate) solids, dissolved solids and solids absorbed on the active clay fraction.

Recommended EMC were defined from the NURP database and other databases as given in Table 4-11 based on land use. Some of these values are used in the examples at the end of this section. Again, local data collection is encouraged to develop more accurate information for the sites being considered.

Table 4-11 Event Mean Concentrations for Nitrogen, Phosphorus and Indicator Bacteria^a

<i>Land Use</i>	<i>EMC_N</i> (mg/l)	<i>EMC_P</i> (mg/l)	<i>EMC_B^b</i> (number/100ml)
Forest	1.69	0.10	100
Low density residential	1.88	0.40	20,000
Medium density residential	1.88	0.40	20,000
High density residential	1.90	0.29	20,000
Industrial and commercial	1.90	0.23	20,000

^a Summarized from Schueler (1987) and Thomson et al. (1997)

^b Fecal coliform is used as the reference bacteria in this case data is based on Schueler et al. (2000). Other more conservative values may apply. If a different bacteria is used, a different value would need to be developed.

Total Loading

The actual loading is given by:

$$\begin{aligned}
 Y_N &= (EMC_N)(\gamma QA) Const_4 \\
 Y_P &= (EMC_P)(\gamma QA) Const_4
 \end{aligned}
 \tag{4-35}$$

where: Y_N = yield of nitrogen in kg (lb),
 Y_P = yield of phosphorus in kg (lb),
 EMC_N and EMC_P = EMCs for nitrogen and phosphorus in mg/l,
 Q = runoff volume in cm (in),
 A = watershed area in ha (acre), and
 $Const_4$ = a constant defined in equation 4-26.

Other chemical pollutants can be calculated in a similar manner.

Settleable Fraction of EMC

A fraction of the EMC is composed of small particles that are blown in on the wind from surrounding areas. In order to be windborn, the particles must be in the clay-size range. The fraction yield of settleable solids that are or sorb nitrogen and phosphorus, $Y_{S,N}$ and $Y_{S,P}$, respectively, on a mass basis in kg (lb) would be given by:

$$\begin{aligned}
 Y_{S,N} &= F_{S,N} Y_N \\
 Y_{S,P} &= F_{S,P} Y_P
 \end{aligned}
 \tag{4-36}$$

where $F_{S,N}$ and $F_{S,P}$ are the fractions of nitrogen and phosphorus that are settleable (subscript **S**). A database is not available to use for $F_{S,N}$ and $F_{S,P}$, thus local data collection is needed for accurate prediction. As a default, Hayes et al. (2001) found that using a value of 0.33 for both phosphorus and nitrogen yields results that predict trapping efficiencies in reservoirs (EPA reservoir sedimentation model for predicting trapping, Driscoll et al., 1986) in the range of 20 to 30%. This number corresponds to the NURP database (Stahre and Urbonas, 1990, and Haan et al.,

1994); therefore 0.33 can be used as a first estimate.

Settleable solids for other chemicals can be evaluated using similar procedures to that for nutrients.

Isotherms for Distributing Nitrogen and Phosphorus Between the Dissolved and Sorbed Phase

Nutrients left after settleable solids are accounted for are distributed between the dissolved phase and those sorbed on the surface of the active clay fraction. This division can be done with an empirically defined isotherm that determines the mass sorbed on the surface of clay particles given the concentration in the dissolved phase. Isotherms are typically curvilinear relationships that are difficult to solve in a spreadsheet. Therefore, it can be assumed that the sorption isotherm could be represented by a linear form with a maximum value, or:

$$C_S = KC_D \quad C_S \leq C_{Smax} \tag{4-37}$$

where: C_S = the concentration on the sorbed phase in $\mu\text{g/g}$,
 C_D = concentration in the dissolved phase in mg/l ,
 K = the phase change constant in $\mu\text{g/g/mg/l}$, and
 C_{Smax} = the maximum value for C_S .

K and C_{max} should be based on actual sorption data for the given soil and be based only on the mass of active clay size particles, and not total mass of soil, since the mass of active clay is the point of sorption. An example of constants for equation 4-37 for nitrogen and phosphorus are shown in Table 4-12 (Hayes et al., 2001). Isotherms for other chemical pollutants can also be performed and can be evaluated into these procedures similar to nutrients.

Table 4-12 Example Isotherm Values for Coastal South Carolina

Chemical	K ($\mu\text{g/g/mg/l}$ or $\text{number/g/number/100 ml}$)	$C_{S,max}$ ($\mu\text{g/g}$ or number/g)
Nitrogen	500	1000
Phosphorus	323	750

Equation 4-37 can be used to determine the concentrations in the following manner. First, the mass or yield of total dissolved and sorbed nutrient, $Y_{DS,N}$ and $Y_{DS,P}$, is given by:

$$\begin{aligned} Y_{DS,N} &= Y_N - Y_{S,N} \\ Y_{DS,P} &= Y_P - Y_{S,P} \end{aligned} \tag{4-38}$$

and then the concentration of total dissolved and sorbed nutrient, $C_{DS,N}$ and $C_{DS,P}$, is given by:

$$\begin{aligned} C_{DS,N} &= \frac{Y_{DS,N}}{\gamma QA Const_4} \\ C_{DS,P} &= \frac{Y_{DS,P}}{\gamma QA Const_4} \end{aligned} \tag{4-39}$$

where: $Y_{DS,N}$ = yield of dissolved and sorbed nitrogen in kg (lb),
 $Y_{DS,P}$ = yield of dissolved and sorbed phosphorus in kg (lb),
 $C_{DS,N}$ = total concentration of dissolved and sorbed nitrogen in mg/l ,

$C_{DS,P}$ = total concentration of dissolved and sorbed phosphorus in mg/l,
 Q = runoff volume in cm (in.),
 A = area in ha (acre), and
 $Const_4$ = a constant defined in equation 4-26.

Using the above equations, the concentration of nutrients sorbed on the active clay surfaces can be given by:

$$C_{DS} = C_S C_{AC} \times 10^{-6} + C_D \quad (4-40)$$

where: C_{AC} = concentration of active clay in mg/l and
 C_{DS} = dissolved and sorbed concentration of a pollutant in mg/l.

This term C_{AC} is given by the following equation:

$$C_{AC} = \frac{Y_{AC}}{\gamma Q A Const_4} \quad (4-41)$$

where: Y_{AC} = yield of active clay size particles in kg (lb) as defined by equation 4-30 and other terms as defined earlier.

Concentrations on the dissolved phase, C_D , and the sorbed phase, C_S , for nutrients can be determined by solving equations 4-37 and 4-40, or:

$$C_{D,N/P} = \frac{C_{DS,N/P}}{K C_{AC} 10^{-6} + 1} \quad (4-42)$$

and

$$C_{S,N/P} = \frac{C_{DS,N/P}}{C_{AC} 10^{-6} + 1/K} \quad (4-43)$$

where: $C_{DS,N/P}$ = dissolved and sorbed concentration of nitrogen or phosphorous in mg/l.

Composite Nutrient and Pollutant Yield for Pervious and Impervious Areas

In the absence of major reduction of nutrients and pollutants in the delivery system, the total yield is the sum of the yields from the impervious and pervious areas. Likewise, the mass adsorbed on the active phase is the sum of that from the impervious and pervious areas.

Example Problems on Runoff and Loading

Example Problem 4.1: Runoff and Peak Discharge Flowing Into BMP

A 20 acre single family residential development is being proposed with houses on 1/4 acre lots. The houses occupy 40% of the watershed and drain across the lawns before reaching storm sewer inlets. Streets and sidewalks occupy 10% of the area and drain directly to storm sewer inlets. The time of concentration for the lots draining to the storm sewer inlets is 0.15 hr and for the streets is 0.10 hr. The NRCS HSG is B. If the location of the watershed is in Beaufort, SC, what is the runoff volume, Q and peak discharge, q for a NRCS storm with a precipitation amount of 0.75 in. and antecedent moisture condition III (AMC III).

Solution:

Because the streets may drain to separate locations from the lots and because the houses drain over the lawns before reaching defined channels, calculations will be made separately for the streets and for the lots. The lots will be referred to as pervious and unconnected impervious areas since the roof, sidewalk and driveway will be assumed to drain over the lawn. The streets will be referred to as impervious areas directly connected to drains.

1. Development of Curve Numbers (**CN**).

a. Pervious areas and unconnected impervious areas:

The curve number for the pervious areas from Table 4-2 is 61 for HSG B, and is 98 for impervious areas. Both of these **CN** values are for antecedent moisture condition II (AMC II). The houses, sidewalks and driveways on the lots are assumed to drain across lawns before entering drainage inlets; therefore the curve numbers must be area weighted. Recalling that the impervious areas on the lots represent 40% of the area (fraction unconnected impervious, $F_{UCI} = 0.40$) and the pervious areas represent 50% of the area (fraction pervious, $F_{Pe} = 0.50$), the area weighted curve number (as described in Equation 3-1) for AMC II for the combined pervious and impervious unconnected areas would be:

$$CN_{II,Pe+UCI} = \frac{F_{Pe} CN_{II,Pe} + F_{UCI} CN_{II,UCI}}{F_{Pe} + F_{UCI}} = \frac{(0.50)(61) + (0.4)(98)}{(0.5 + 0.4)} = 77.4$$

Since these values are for AMC II, conversion to AMC III must be accomplished with equation 4-8 or:

$$CN_{III,Pe+UCI} = \frac{23 CN_{II,Pe+UCI}}{10 + 0.13 CN_{II,Pe+UCI}} = \frac{(23)(77.4)}{10 + (0.13)(77.4)} = 88.8$$

b. Impervious areas:

The **CN** is:

$$CN_{III,Im} = \frac{23 CN_{II,Im}}{10 + 0.13 CN_{II,Im}} = \frac{(23)(98)}{10 + (0.13)(98)} = 99.1$$

The subscripts **Im**, **Pe** and **UCI** in the above and following equations refer to impervious, pervious and unconnected impervious areas, respectively.

2. Calculation of maximum retention parameter, **S**. In the following computations, the first subscript, **III**, for **CN**, will be deleted, but is understood.

a. Pervious and unconnected impervious areas:

Using equation 4-7:

$$S_{Pe+UCI} = \frac{1000}{CN_{Pe+UCI}} - 10 = \frac{1000}{88.8} - 10 = 1.266$$

b. Impervious areas:

$$S_{Im} = \frac{1000}{CN_{Im}} - 10 = \frac{1000}{99.1} - 10 = 0.089$$

3. Runoff volume.

a. Pervious and unconnected impervious areas:

Using equations 4-6, the runoff volume in watershed in. (using a value of 1.0 for **Const₁**) is:

$$Q_{Pe+UCl} = \frac{(P - 0.2 S_{Pe+UCl})^2}{P + 0.8 S_{Pe+UCl}} = \frac{(0.75 - 0.2 \times 1.266)^2}{0.75 + 0.8 \times 1.266} = 0.140 \text{ in.}$$

b. Impervious areas:

$$Q_{Im} = \frac{(P - 0.2 S_{Im})^2}{P + 0.8 S_{Im}} = \frac{(0.75 - 0.2 \times 0.089)^2}{0.75 + 0.8 \times 0.089} = 0.653 \text{ in.}$$

c. Using equations 4-9, the total runoff volume becomes:

$$\begin{aligned} Q_T &= \frac{Q_{Im} A_{Im} + Q_{Pe+UCl} A_{Pe+UCl}}{A_T} = \frac{A_{Im}}{A_T} Q_{Im} + \frac{A_{Pe+UCl}}{A_T} Q_{Pe+UCl} \\ &= (0.1)(0.653) + (0.9)(0.140) = 0.191 \text{ in.} \end{aligned}$$

4. Peak runoff rates.

a. Pervious and unconnected impervious areas:

First, the following ratio is calculated using equation 4-6a:

$$\frac{I_a}{P} = \frac{0.2S}{P} = \frac{0.2(1.266)}{0.75} = 0.338$$

Then, using the equations in Table 4-3, the following constants, for use in equation 4-10b for the unit peak discharge, can be calculated:

$$\begin{aligned} C_0 &= -2.0346 \left(\frac{I_a}{P} \right)^2 + 0.489 \left(\frac{I_a}{P} \right) + 2.4433 \\ &= -2.0346 (0.338)^2 + 0.489 (0.338) + 2.4433 = 2.376 \end{aligned}$$

$$\begin{aligned} C_1 &= 2.0157 \left(\frac{I_a}{P} \right)^2 - 0.8351 \left(\frac{I_a}{P} \right) + 0.4538 \\ &= 2.0157 (0.338)^2 - 0.8351 (0.338) + 0.4538 = -0.50595 \end{aligned}$$

$$\begin{aligned} C_2 &= 0.1799 \left(\frac{I_a}{P} \right) - 0.187 \\ &= 0.1799 (0.338) - 0.187 = -0.12625 \end{aligned}$$

Using these constants, the unit peak discharge can be calculated from equation 4-10b, or:

$$\begin{aligned}\log(q_{u,Pe+UCI}) &= C_0 + C_1 \log t_{c,Pe+UCI} + C_2 (\log t_{c,Pe+UCI})^2 \\ &= 2.376 - 0.50595 \log(0.15) - 0.12625 [\log(0.15)]^2 \\ &= 2.70758\end{aligned}$$

$$q_{u,Pe+UCI} = 10^{2.70758} = 510.0 \frac{ft^3 / s}{in - mi^2}$$

The peak discharge is calculated from equation 4-10a (assuming that the pond factor is 1.0):

$$\begin{aligned}q_{p,Pe+UCI} &= q_{u,Pe+UCI} A_{Pe+UCI} Q_{Pe+UCI} F \\ &= 510 \times (18/640) \times 0.140 \times 1.0 = 2.008 \text{ cfs}\end{aligned}$$

b. Impervious areas:

The value for I_a/P is calculated:

$$\frac{I_a}{P} = \frac{0.2S}{P} = \frac{0.2(0.089)}{0.75} = 0.023$$

As noted in the bottom cell of Table 4-3, if I_a/P is less than 0.1, a value of 0.1 is used. Using the appropriate equations from Table 4-3, the values for the constants for equation 4-10b are: $C_0 = 2.471854$; $C_1 = -0.51715$; and $C_2 = -0.16901$. Using these constants in equation 4-10b, the unit peak discharge can be calculated as:

$$\begin{aligned}\log(q_{u,lm}) &= C_0 + C_1 \log t_{c,lm} + C_2 (\log t_{c,lm})^2 \\ &= 2.471854 - 0.51715 \log(0.10) - 0.16901 [\log(0.10)]^2 = 2.81997\end{aligned}$$

and

$$q_{u,lm} = 10^{2.81997} = 660.7 \frac{ft^3 / s}{in - mi^2}$$

Using equation 4-10a, the peak discharge for the streets is:

$$q_{p,lm} = q_{u,lm} A_{lm} Q_{lm} F = 660.7 \times (2/640) \times 0.653 \times 1.0 = 1.348 \text{ ft}^3 / s$$

Note that these peak discharges are for all of the streets combined and all of the houses and lawns combined. These discharges will likely be combined on a distributed basis prior to reaching the watershed outlet.

Example Problem 4.2: Calculating Average Runoff and Peak Discharge

The rainfall amounts, and associated probabilities for rainfall, season and AMC conditions for the Charleston, SC Airport were given in Table 4-1. Using similar conditions and probabilities for another location, Beaufort, SC, and the procedures in Example Problem 4-1, determine the runoff volume and the peak discharge in an average storm. Compare this to estimates made with the runoff coefficient given by equation 4-4.

Solution:

Results of calculations are summarized here in tabular form in Table 4-13. The procedures shown in Example

Problem 4-1 were utilized to develop the numbers. These procedures are computerized into a spreadsheet model known as the IDEAL model (Hayes et al., 2001).

An examination of values for peak discharge shows that increasing the effective abstraction above 0.1 in. increases the discharge slightly whereas one would expect it to decrease. This results from slight inaccuracies in the regression equations for the coefficients at small times of concentrations. The inaccuracies are slight and the predicted peak discharge errors are minor.

The expected value of any of the values can be obtained by multiplying the quantity by the joint probability (pT) of precipitation, season and AMC, and summing across the rows. This give the expected value, given that the precipitation is 0.75 in. The probability of a precipitation of 0.75 in. in a given storm is given as 0.1683 as shown in row three of the table. Using that value, the expected values of runoff and peak discharge in a storm of 0.75 in. were calculated and summarized in Table 4-14 of this example problem.

Table 4-13 Precipitation Information and Probabilities and Spreadsheet Calculations

Conditions and Probabilities for Beaufort, South Carolina						
(1) Rainfall Class Number	2	2	2	2	2	2
(2) Precipitation (P) (in.)	0.75	0.75	0.75	0.75	0.75	0.75
(3) Probability of Precipitation ($p_k(P_k)$)	0.1683	0.1683	0.1683	0.1683	0.1683	0.1683
(4) Season	Growing	Growing	Growing	Dormant	Dormant	Dormant
(5) Probability of Season ($p_j(S_{season,i,k})$)	0.6938	0.6938	0.6938	0.3062	0.3062	0.3062
(6) Antecedent Moisture Condition (AMC)	1	2	3	1	2	3
(7) Probability of AMC ($p_i(A_{MC,i,j,k})$)	0.7596	0.0999	0.1405	0.6318	0.1903	0.1779
(8) Joint Probability ($p_T = p_k * p_j * p_i$)	0.0887	0.0117	0.0164	0.0326	0.0098	0.0092
Calculations for Connected Impervious Area						
(9) Curve Number (CN)	95.37	98.00	99.12	95.37	98.00	99.12
(10) S	0.4859	0.2041	0.0887	0.4859	0.2041	0.0887
(11) Q (in.) (P-0.2 S \$0)	0.3743	0.5507	0.6531	0.3743	0.5507	0.6531
(12) A (acre)	2	2	2	2	2	2
(13) Q (ac-ft)	0.0624	0.0918	0.1089	0.0624	0.0918	0.1089
(14) t_c (hr)	0.1	0.1	0.1	0.1	0.1	0.1
(15) Initial Abstraction I_a/P	0.1296	0.0544	0.0237	0.1296	0.0544	0.0237
(16) Effective Initial Abstraction (0.1 # I_a/P)	0.1296	0.1	0.1	0.1296	0.1	0.1
(17) $\log q_u$	2.8370	2.8200	2.8200	2.8370	2.8200	2.8200
(18) q_u (cfs/in-mi²)	687.03	660.69	660.69	687.03	660.69	660.69
(19) q_p (cfs)	0.8035	1.1370	1.3485	0.8035	1.1370	1.3485
Calculations for Pervious and Unconnected Impervious						
(20) Curve Number (CN)	59.05	77.44	88.76	59.05	77.44	88.76
(21) S	6.93	2.91	1.27	6.93	2.91	1.27
(22) Q (in.) (P-0.2 S \$0)	0.0000	0.0091	0.1400	0.0000	0.0091	0.1400
(23) A (acre)	18	18	18	18	18	18
(24) Q (ac-ft)	0.0000	0.0137	0.2099	0.0000	0.0137	0.2099
(25) t_c (hr)	0.15	0.15	0.15	0.15	0.15	0.15
(26) Initial Abstraction I_a/P	1.8492	0.7767	0.3377	1.8492	0.7767	0.3377
(27) Effective Initial Abstraction (I_a/P #0.5)	0.5	0.5	0.3377	0.5	0.5	0.3377
(28) q_u (cfs/in-mi²)	260.6	260.6	510.0	260.6	260.6	510.0
(29) q_p (cfs)	0.0000	0.0668	2.0076	0.0000	0.0668	2.0076
Summary for Total Watershed						
(30) A (acre)	20	20	20	20	20	20
(31) Q (ac-ft)	0.0624	0.1054	0.3188	0.0624	0.1054	0.3188
(32) Q (in.)	0.0374	0.0633	0.1913	0.0374	0.0633	0.1913
(33) q_p (cfs)	0.8035	1.2038	3.3560	0.8035	1.2038	3.3560
Calculations for Pervious and Unconnected Impervious						
(34) $P * p_T$ (in.)	0.0665	0.0087	0.0123	0.0244	0.0074	0.0069
(35) $Q * p_T$ (ac-ft)	0.0055	0.0012	0.0052	0.0020	0.0010	0.0029
(36) $Q * p_T$ (in.)	0.0033	0.0007	0.0031	0.0012	0.0006	0.0018
(37) $q_p * p_T$ (cfs)	0.0713	0.0140	0.0551	0.0262	0.0118	0.0308

Table 4-14 Expected Value of Runoff and Peak Discharge for a Precipitation Class of 0.75 inches for Example Problem 4.2

Item	Sum Across Rows	Item	Expected Value (Sum Divided by Probability Precipitation Amount)
$P \cdot p_T$ (in.)	0.1684	$P \cdot p_T / p_p$ (in.)	0.75
$Q \cdot p_T$ (ac-ft)	0.0178	$Q \cdot p_T / p_p$ (ac-ft)	0.1060
$Q \cdot p_T$ (in.)	0.0107	$Q \cdot p_T / p_p$ (in.)	0.0636
$q_p \cdot p_T$ (cfs)	0.2092	$q_p \cdot p_T / p_p$ (cfs)	1.2460

The expected value of runoff volume for an event of 0.75 in. is 0.106 ac-ft or 0.0636 watershed in. The expected value of peak discharge is 1.246 cfs. These values, again, are what would be expected to occur from a storm with 0.75 in., considering the possibility that it might occur in a dormant or growing season and that it may occur under dry, average or wet conditions.

The following are results in Table 4-15 are from the IDEAL model based on conditions, probabilities and joint probabilities for all storms of Beaufort, SC (results based on model, additional conditions and probabilities provided in IDEAL spreadsheet).

Table 4-15 Expected Value of Runoff and Peak Discharge for a Precipitation Class of 0.75 inches for Example Problem 4.2

Runoff and Peak Discharges	Average Storm	Annual Storm ¹	Total Amount ²
P (in.)	0.562	4.0	56.21
Q (ac-ft)	0.118	2.3598	11.83
Q (in.)	0.071	1.4159	7.10
q_p (cfs)	1.340	23.036	
Fraction Rainfall that becomes Runoff	0.126	0.3540	0.126

¹The annual design storm for Coastal South Carolina is 4.0 in.

²Total Ammount = 100 x Average Storm, based on average interval between storms of 89 hr for Coastal South Carolina.

A fact that should be emphasized is that the example storm being considered, 0.75 in., although larger than the average storm, has a lower runoff and peak discharge than the average storm. This result is caused by the nonlinearity of hydrologic processes. Mathematically, this is defined by equation 4-1. If we let X be precipitation value P , then the equation would define the mean precipitation. If we define X as runoff volume, then the equation would define average runoff volume. However, runoff volume is a non-linear function of precipitation and a given incremental increase in precipitation at 4 in. will have a greater incremental increase in runoff volume than would happen at 0.5 in. This means that runoff volume is increasing more rapidly than precipitation at the higher values. To get an expected value, however, we are multiplying by the joint probability, p_T of $p_i(A_{MC,i,j,k})$, $p_j(S_{eason,j,k})$ and $p_k(P_k)$. Only $p_k(P_k)$ is changing with precipitation, but it is decreasing dramatically as the precipitation increases. Thus, the runoff volume for a single precipitation corresponding to the average storm will not be the same as the average runoff volume. That is why the average runoff volume is greater than the runoff volume from the 0.75 inch event, even though the average precipitation is about 0.5 inches.

The results from the statistical average can be compared to those of the runoff coefficient method in equation 4-5, for the average storm, the runoff will be:

$$Q = R_v P = [0.05 + 0.009(I)] P$$

$$= [0.05 + 0.009(50)] \times 0.562 = 0.281 \text{ in.}$$

This runoff is much larger than that predicted by the statistical approach using the curve number. This illustrates that

simple application of the runoff coefficient for pervious areas may over estimate runoff in certain circumstances where there are significant disconnected areas and antecedent moisture conditions are not taken into account.

Example Problem 4.3: Yield and Size Distribution of Sediment to BMP

Estimate the sediment yield, sediment size distribution and fraction of clay sized particles in runoff from the watershed in Example Problem 4.1 and 4.2 for a rainfall of 0.75 in. and for an average storm. Assume that the NRCS soils maps have been consulted and found that the surface soil in the watershed has been found to be a sandy loam with a composition of 70% sand, 20% silt and 10% clay. For the pervious areas, the slopes average 2%, the slope lengths are 100 ft and the soil erodibility is 0.24 (from Haan et al., 1994, Table 8.4). The fraction of grass cover in the lawn is 1.0 and the average height of the grass cover is 0.1 ft.

Solution:

In the absence of empirical data, the EMC of sediment will be used for sediment from the impervious areas and the MUSLE will be used for the combined pervious impervious areas not connected to drains. The size distribution of the sediment from the pervious area will be determined from the CREAMS equations in Table 4-8 and impervious areas will be determined from the NURP data base in Table 4-7.

1. Sediment Yield.

a. Pervious and impervious unconnected:

The MUSLE equation for sediment yield, equation 4-21, requires runoff volume Q in ac-ft and peak discharge q_p in cfs along with the soil loss equation parameters of $KLSCP$. From Example Problem 4.1 q_p is 2.008 cfs and Q is 0.140 in. or $(0.140 \text{ in})(18 \text{ ac})/12 \text{ (in/ac)} = 0.2099 \text{ ac-ft}$. K is given as 0.24, CP from Table 4-6 is 0.01 for 100% cover and grass height of 0.1 ft, and LS is determined from equations 4-24 and 4-25. Given that the slope is 2%, the slope angle is:

$$\theta = \tan^{-1}(0.02) = 0.01999 \text{ rad or } 1.14 \text{ deg}$$

From equation 4-25, assuming a low tendency to rill, β is:

$$\beta = f_r \frac{11.16 \sin \theta}{3.0 \sin \theta^{0.8} + 0.56} = 0.5 \frac{11.16 \sin(0.01999)}{3.0 \sin(0.01999)^{0.8} + 0.56} = 0.161$$

and from equation 4-26 the LS factor with $Const_3 = 1$ is:

$$\begin{aligned} LS &= \left(\frac{\lambda}{72.6} \right)^{\beta/1+\beta} (10.8 \sin \theta + 0.03) \\ &= \left(\frac{100}{72.6} \right)^{0.161/1+0.161} (10.8 \sin(0.01999) + 0.03) = 0.257 \end{aligned}$$

Finally, sediment yield can be calculated from the MUSLE (equation 4-21) as:

$$\begin{aligned} Y_{Pe} &= Const_2 (Q_{Pe+UCI} q_{p,Pe+UCI})^{0.56} \{K\}_a \{LS\}_a \{CP\}_a \\ &= 1.9 \times 10^5 \times (0.2099 \times 2.008)^{0.56} \times 0.24 \times 0.257 \times 0.01 = 72.3 \text{ lb} \end{aligned}$$

where the subscript a refers to average values over the watershed, here the pervious and unconnected impervious

areas.

b. Impervious areas directly connected to drains:

Using an EMC of 117 mg/L from Table 4-7 to represent the streets, a runoff volume of 0.653 in., the sediment yield for the impervious directly connected areas is defined from equation 4-27:

$$Y_{im} = (EMC_{SED})(\gamma Q_{im} A_{im}) Const_4$$
$$= 117 \text{ mg/l} \times 62.4 \text{ lb/ft}^3 \times 0.653 \times 2 \text{ ac} \times 0.00363 = 34.6 \text{ lb}$$

c. Total sediment yield:

The total sediment yield in the watershed is given by equation 4-28:

$$Y_T = 72.3 + 34.6 = 106.9 \text{ lb}$$

This indicates that the majority of the sediment came from the pervious areas even though the lawns are well established and mowed to a level of 0.1 ft. The addition of bare areas under trees and shrubs with no mulch could greatly increase the sediment yield and would need to be accounted for by area weighting the **CP** factor. For example, if half of the lawns were planted in trees with 30 ft average height canopies with an average above ground coverage of 50% and the ground cover was 50%, the **CP** factor for the area would be 0.132, based on the equations at the bottom of Table 4-6. In this case, the sediment yield would be 988 lb.

d. Expected average sediment yield in an average storm using IDEAL:

Using the same procedures as shown in Example Problem 4.2, calculations can be made of the expected average sediment yield, using the spreadsheet model IDEAL. These values were calculated for the Beaumont, SC watershed area with the following results:

Average sediment yield in a storm	46.1 lb
Average concentration (yield/runoff)	143.2 mg/l.

2. Eroded Size Distributions.

The CREAMS equations will be used to calculate sediment size from the pervious areas, based on the fraction of clay, silt and sand primary particles in the parent material. These fractions were given as 0.1, 0.2 and 0.7 for the sandy loam soil. Table 4-16 can be created, using the equations in Table 4-8. Also shown are the fractions for the impervious areas based on Table 4-9.

Table 4-16 Fraction of Sediment by Class Based on Soil Matrix Fractions for Example Problem 4.3

Class	Equation for Fraction of Sediment in Class – Pervious Area	Fraction Pervious Area	Fraction Impervious Area
Primary Clay (cl)	$F_{cl} = 0.26 \quad O_{cl} = 0.26(0.1)$	0.026	0.260
Primary Silt (si)	$F_{si} = O_{si} - F_{sg} = 0.2 - 0.18$	0.020	0.550
Primary Sand (sa)	$F_{sa} = O_{sa}(1 - O_{cl})^{5.0} = 0.7(1 - 0.1)^{5.0}$	0.413	0.190
Small Aggregate (sg)	$F_{sg} = 1.8 \quad O_{cl} = 1.8(0.1)$	0.180	0.000
Large Aggregate (lg)	$F_{lg} = 1 - F_{cl} - F_{si} - F_{sa} - F_{sg} = 1 - 0.026 - 0.020 - 0.413 - 0.18$	0.361	0.000
	Sum	1.000	1.000

Representative diameters are calculated using the equations in Table 4-8a along with the specific gravities and summarized below in Table 4-17 along with the fraction of clay sized particles in each size class are calculated using equations in Table 4-10.

Table 4-17 Representative Diameters by Classes Based on Soil Matrix Fractions for Example Problem 4.3

Class	Representative Diameter (mm)	Specific Gravity	Fraction of TSS is the Particle Class That is Clay Sized Particles – CF	
			Pervious Areas	Impervious Areas
Primary Clay (cl)	$D_{cl} = 0.002$	2.65	1.00	1.00
Primary Silt (si)	$D_{si} = 0.010$	2.65	0	0
Primary Sand (sa)	$D_{sa} = 0.200$	2.65	0	0
Small Aggregate (sg)	$D_{sg} = 0.030$	1.80	0.33	0
Large Aggregate (lg)	$D_{lg} = 0.30$	1.60	0.014	0

The mass of clay sized particles can be determined from the results in Table 4-16 and 4-17 above, using equation 4.29, repeated here for ease of reference:

$$Y_{CP} = \sum_{j=1}^2 Y_j \sum_{i=1}^5 F_{ij} CF_{ij}$$

The results are tabulated in Table 4-18.

Table 4-18 Calculation of Mass of Clay Sized Particles in Discharge for Example Problem 4.3

Area	Pervious and Unconnected Impervious			Connected Impervious		
Total Sediment Yield Y_j (lb)	72.5			34.62		
Particle Class	Fraction in Class	Fraction Clay Sized Particles	Mass of Clay Sized Particles lb	Fraction in Class	Fraction Clay Sized Particles	Mass of Clay Sized Particles lb
	F_i	CF_i	$Y_{pe} F_i CF_i$	F_i	CF_i	$Y_{im} F_i CF_i$
Primary Clay (cl)	0.026	1.000	1.89	0.06	1.000	9.00
Primary Silt (si)	0.020	0.000	0.00	0.16	0.000	0.00
Primary Sand (sa)	0.413	0.000	0.00	0.78	0.000	0.00
Small Aggregate (sg)	0.180	0.333	4.33	0	0.000	0.00
Large Aggregate (lg)	0.361	0.014	0.37	0	0.000	0.00
Sum	1.000		6.58	1.000		9.00
Total Watershed Yield of Clay Sized Particles, Y_{cp} , is 6.58+9.00=15.58 lb						

Example Problem 4.4: Yield of Chemicals to BMP

Calculate the yield of nutrients to the BMP for the watershed in Example Problem 4.1, 4.2 and 4.3. Also determine the mass of active clay fraction entering the BMP.

Solution:

1. Total Yield of Nitrogen and Phosphorus.

a. Total yield:

The total yield of nutrients is based on EMC. From Table 4-11, the EMC values for nitrogen and phosphorus are 1.88 mg/l and 0.40 mg/l, respectively, for both pervious and impervious areas.

Using the results from Example Problems 4.1, 4.2 and 4.3 and equation 4-35, the yield of phosphorus and nitrogen from each of the areas can be calculated as:

$$\begin{aligned}
 (Y_N)_{pe+UCL} &= ((EMC_N)(\gamma QA))_{P+UCL} \text{ Const}_4 \\
 &= (1.88)(62.4)(0.140)(18)(0.00363) = 1.072 \text{ lb}
 \end{aligned}$$

$$\begin{aligned}
 (Y_P)_{P+UCL} &= ((EMC_P)(\gamma QA))_{P+UCL} \text{ Const}_4 \\
 &= (0.40)(62.4)(0.140)(18)(0.00363) = 0.228 \text{ lb}
 \end{aligned}$$

Similar calculations can be made for the impervious area of 2 acres using Q of 0.653 in. yielding 0.556 and 0.118 lb for nitrogen and phosphorus respectively. Thus the total load from all areas would be 1.63 and 0.35 lb for nitrogen and phosphorus respectively.

b. Particulate (settleable) fraction:

The EMC for nutrients contain both dissolved and particulate (settleable) matter that are trapped by different mechanisms, hence partitioning is necessary. In the absence of data for partitioning coefficients $F_{S,N}$ and $F_{S,P}$, values of 0.33 suggested in the text will be used in equation 4-36, thus the particulate mass for both phosphorus and nitrogen can be calculated as:

$$(Y_{S,N})_{Pe+UCI} = (F_{S,N} Y_N)_{Pe+UCI} = 0.33(1.07) = 0.354 \text{ lb}$$

$$(Y_{S,P})_{Pe+UCI} = (F_{S,P} Y_P)_{Pe+UCI} = 0.33(0.228) = 0.075 \text{ lb}$$

Similar calculations can be made for the impervious area, resulting in 0.183 and 0.03894 lb for particulate nitrogen and phosphorus, respectively.

c. Mass of active clay:

Active clay is the clay sized particles that participate in the sorption of nutrients. This is assumed to be all soil particles in the clay fraction. Using equation 4-30 areas, the results from Table 4-18 and the particulate mass, $Y_{S,k}$, (as calculated by equation 4-36), the mass of active clay can be calculated as:

$$(Y_{AC})_{Pe+UCI} = \left(Y_{CP} - \sum_{k=1}^2 Y_{S,k} \right)_{Pe+UCI} = 6.58 - (0.075 + 0.354) = 6.15 \text{ lb}$$

$$(Y_{AC})_I = \left(Y_{CP} - \sum_{k=1}^2 Y_{S,k} \right)_I = 9.00 - (0.039 + 0.183) = 8.78 \text{ lb}$$

d. Values for an average storm and average annual:

Following the procedures in Example Problem 4.2, an expected value or value of nutrient and active clay yield for the watershed can be calculated using the IDEAL model. The values for the Beauford, South Carolina area are:

	Total P (lb)	Particulate P (lb)	Total N (lb)	Particulate N (lb)	Active Clay (lb)
Avg. Storm	0.1287	0.05	0.6048	0.23	6.86
Annual (100 storms)	12.87	4.93	60	23.21	686

The average interval between storms is 89 hrs for Coastal SC, which is approximately 100 storms per year. In this case, the yield of chemicals are less for the average storm as calculated by IDEAL, than for the storm of 0.75 in. while the inverse is true for active clay.

Example Problem 4.5: Partitioning Chemicals Between Sorbed Phase and Dissolved Phase

Partition the phosphorus and nitrogen in the discharge from the watershed in Example 4.4 among the sorbed phase and dissolved phase, again using the precipitation of 0.75 in. during the dormant season with AMC III.

Solution:

1. Pervious and Unconnected Impervious Areas.

Equations 4-37 through 4-43 are used to partition the nutrients between the sorbed and dissolved phase. The calculations will be done only for the pervious and unconnected impervious area. First the concentration of active clay (clay sized particles minus particulate nitrogen and phosphorus) must be calculated from equation 4-41:

$$(C_{AC})_{Pe+UCI} = \left(\frac{Y_{AC}}{\gamma QA Const_4} \right)_{Pe+UCI} = \frac{6.15}{62.4 \times 0.140 \times 18 \times 0.00363} = 10.8 \text{ mg / l}$$

The sum of dissolved and sorbed phosphorus or nitrogen will be the total of mass minus the particulate mass, or from equation 4-38 is:

$$(Y_{DS,N})_{Pe+UCI} = (Y_N - Y_{NS})_{Pe+UCI} = 1.072 - 0.354 = 0.72 \text{ lb}$$
$$(Y_{DS,P})_{Pe+UCI} = (Y_P - Y_{PS})_{Pe+UCI} = 0.228 - 0.075 = 0.15 \text{ lb}$$

The concentration of dissolved and sorbed phosphorus and nitrogen is calculated by equation 4-39:

$$(C_{DS,N})_{Pe+UCI} = \left(\frac{Y_{DS,N}}{\gamma QA Const_4} \right)_{Pe+UCI} = \frac{0.72}{62.4 \times 0.140 \times 18 \times 0.00363} = 1.26 \text{ mg / l}$$
$$(C_{DS,P})_{Pe+UCI} = \left(\frac{Y_{DS,P}}{\gamma QA Const_4} \right)_{Pe+UCI} = \frac{0.15}{62.4 \times 0.140 \times 18 \times 0.00363} = 0.268 \text{ mg / l}$$

From equations 4-42 and 4-43 for nitrogen and phosphorus, and using respective partitioning coefficients of $K_p=323 \text{ } \mu\text{g/g/mg/l}$ and $K_N = 500 \text{ } \mu\text{g/g/mg/l}$, and maximum concentrations, $C_{S,max,P} = 750 \text{ } \mu\text{g/g}$ and $C_{S,max,N} = 1000 \text{ } \mu\text{g/g}$, the dissolved and sorbed phase concentrations are:

$$(C_{D,N})_{Pe+UCI} = \left(\frac{C_{DS,N}}{K_N C_{AC} 10^{-6} + 1} \right)_{Pe+UCI} = \frac{1.26}{500 \times 10.8 \times 10^{-6} + 1} = 1.25 \text{ mg / l}$$
$$(C_{S,N})_{Pe+UCI} = \left(\frac{C_{DS,N}}{C_{AC} 10^{-6} + 1/K_N} \right)_{Pe+UCI} = \frac{1.26}{10.8 \times 10^{-6} + 1/500} = 626 \text{ } \mu\text{g / g}$$

$$(C_{D,P})_{Pe+UCI} = \left(\frac{C_{DS,P}}{K_P C_{AC} 10^{-6} + 1} \right)_{Pe+UCI} = \frac{0.268}{323 \times 10.8 \times 10^{-6} + 1} = 0.267 \text{ mg / l}$$

$$(C_{S,P})_{Pe+UCI} = \left(\frac{C_{DS,P}}{C_{AC} 10^{-6} + 1/K_P} \right)_{Pe+UCI} = \frac{0.268}{10.8 \times 10^{-6} + 1/323} = 86.3 \text{ } \mu\text{g / g}$$

2. Impervious Connected to Drain.

Following the procedures above, the concentration of active clay is:

$$C_{AC,lm} = \left(\frac{Y_{AC}}{\gamma QA \text{ Const}_4} \right)_{lm} = \frac{8.78}{62.4 \times 0.653 \times 2 \times 0.00363} = 29.67 \text{ mg / l}$$

The yields of dissolved and sorbed phosphorus and nitrogen are:

$$(Y_{DS,N})_{lm} = (Y_N - Y_{NS})_{lm} = 0.556 - 0.183 = 0.373 \text{ lb}$$

$$(Y_{DS,P})_{lm} = (Y_P - Y_{PS})_{lm} = 0.118 - 0.039 = 0.079 \text{ lb}$$

$$(C_{DS,N})_{lm} = \left(\frac{Y_{DS,N}}{\gamma QA \text{ const}_4} \right)_{lm} = \frac{0.373}{62.4 \times 0.653 \times 2 \times 0.00363} = 1.26 \text{ mg / l}$$

$$(C_{DS,P})_{lm} = \left(\frac{Y_{DS,P}}{\gamma QA \text{ const}_4} \right)_{lm} = \frac{0.079}{62.4 \times 0.653 \times 2 \times 0.00363} = 0.27 \text{ mg / l}$$

For nitrogen the dissolved and sorbed phase concentrations are:

$$(C_{D,N})_{lm} = \left(\frac{C_{DS,N}}{K_N C_{AC} 10^{-6} + 1} \right)_{lm} = \frac{1.26}{500 \times 29.67 \times 10^{-6} + 1} = 1.24 \text{ mg / l}$$

$$(C_{S,N})_{lm} = \left(\frac{C_{DS,N}}{C_{AC} 10^{-6} + 1/K_N} \right)_{lm} = \frac{1.26}{29.67 \times 10^{-6} + 1/500} = 621 \text{ } \mu\text{g / g}$$

Likewise, the phosphorus concentrations are:

$$(C_{D,P})_{lm} = \left(\frac{C_{DS,P}}{K_P C_{AC} 10^{-6} + 1} \right)_{lm} = \frac{0.268}{323 \times 29.67 \times 10^{-6} + 1} = 0.265 \text{ mg / l}$$

$$(C_{S,P})_{lm} = \left(\frac{C_{DS,P}}{C_{AC} 10^{-6} + 1/K_P} \right)_{lm} = \frac{0.268}{29.67 \times 10^{-6} + 1/323} = 85.7 \text{ } \mu\text{g / g}$$

Summary of Loading

The loadings calculated in Example Problems 4.1 through 4.5 are summarized in Table 4-20 and results for nutrients are shown graphically in the following Figures 4-2 and 4-3. They illustrate that the majority of the nitrogen and phosphorus are in the dissolved state. This may help to explain why standard stormwater detention basins, either wet or dry, do not trap a high percentage of nutrients.

The clay content of the sandy loam soil is very low, thus the total sorption capacity of the soil is reduced relative to a soil with a high clay content. A higher potential for nutrient removal by settling would exist if the clay content were higher.

Table 4-19 Summary of Loading for Example Problems 4.1- 4.5

<i>Runoff</i>	<i>Pervious and Unconnected</i>		<i>Impervious Connected to Drain</i>		<i>Total</i>	
	<i>in</i>	<i>ac-ft</i>	<i>in</i>	<i>ac-ft</i>	<i>in</i>	<i>ac-ft</i>
<i>Rainfall</i>	0.75		0.75		0.75	
<i>Runoff</i>	0.140	0.210	0.653	0.109	0.191	0.319
<i>Peak Discharge</i>	<i>cfs</i>		<i>cfs</i>		<i>cfs</i>	
	2.008		1.348		3.356	
<i>Loading</i>	<i>lb</i>	<i>mg/l</i>	<i>lb</i>	<i>mg/l</i>	<i>lb</i>	<i>mg/l</i>
<i>Sediment Yield</i>						
<i>Sediment</i>	72.3	127	34.6	117	107	123
<i>Active Clay</i>	6.15	10.8	8.78	29.7	14.9	17.2
<i>Nitrogen</i>						
<i>Settleable</i>	0.35	0.62	0.18	0.62	0.54	0.62
<i>Sorbed</i>	0.004	626 : g/g	0.005	621 : g/g	0.009	0.011
<i>Liquid</i>	0.72	1.25	0.37	1.24	1.08	1.25
<i>Total</i>	1.07	1.88	0.56	1.88	1.63	1.88
<i>Phosphorus</i>						
<i>Settleable</i>	0.075	0.13	0.039	0.13	0.11	0.13
<i>Sorbed</i>	0.001	86.4 : g/g	0.001	85.7 : g/g	0.001	0.001
<i>Liquid</i>	0.15	0.27	0.078	0.27	0.231	0.27
<i>Total</i>	0.23	0.40	0.12	0.40	0.35	0.40

Note: Table 4-19 includes values not explicitly calculated in the example problems above. Values in **bold** are based on other values in the table and relationships developed above, e.g. mass liquid nitrogen for pervious and unconnected impervious equals $Y_{DS, N}$ minus sorbed mass nitrogen where sorbed mass nitrogen equals $(C_{D, P})_{Pe+UCI}$ times Y_{AC} . Values of total nitrogen and phosphorous concentration match given values used from Table 4-11 of 0.188 and 0.40 mg/l, respectively.

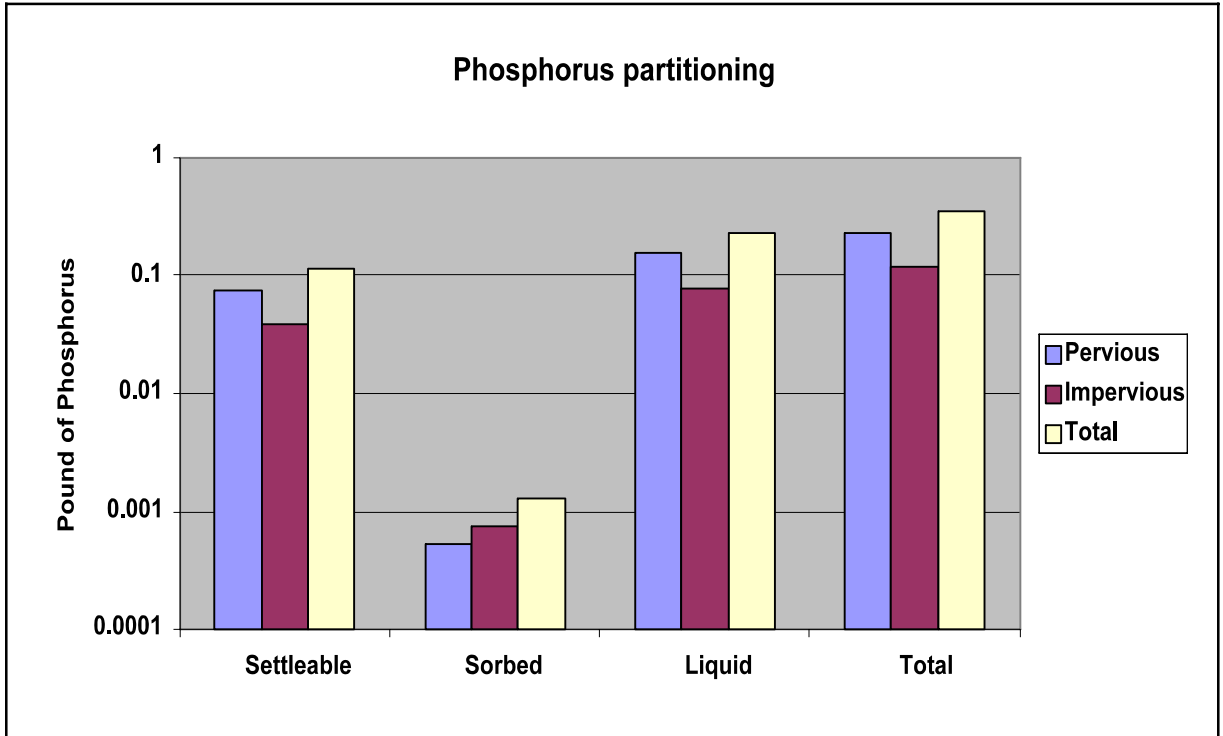

Figure 4-2 Phosphorus Partitioning

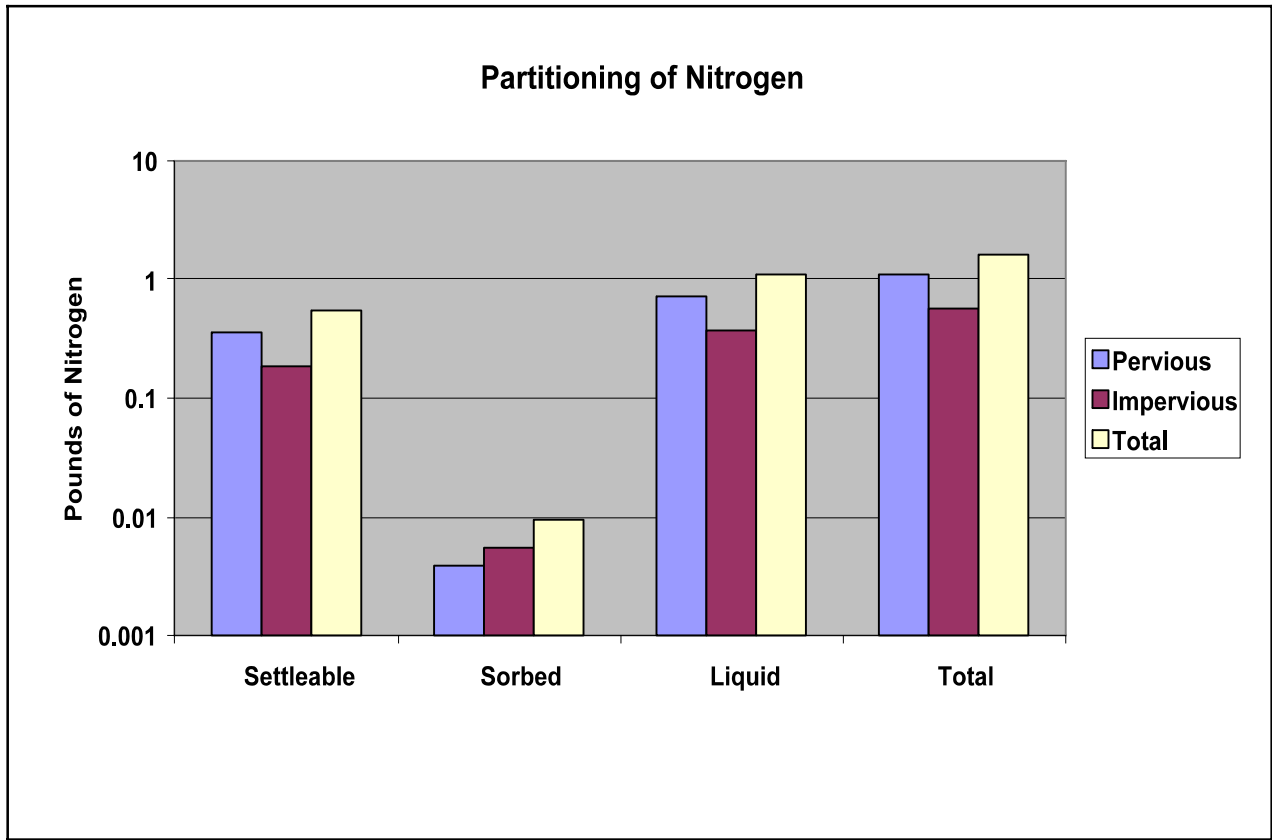

Figure 4-3 Nitrogen Partitioning

Section Five Vegetative Filter Strips

Vegetative filter strips (VFS) are zones of vegetation through which sediment and pollutant-laden flow are directed before being discharged to a concentrated flow channel. They may closely resemble many natural ecological communities such as grassy meadows or riparian forests. Dense vegetative cover facilitates sediment attenuation and pollutant removal. VFS provide little treatment for concentrated flows. Grading and level spreaders can be used to create a uniformly sloping area that distributes the runoff evenly across the filter strip (Haan et al., 1994, Hayes et al., 1984, Barfield and Hayes, 1988 and Dillaha et al., 1989).

This control technique has been described by a number of different terms including: VFS, grass filters, grass filter strips, buffer strips, riparian vegetation buffer strips and constructed filter strips. Filter strips can be natural or constructed.

Constructed filter strips are filter strips that are constructed and maintained to allow for overland sheet flow through the vegetation, primarily grass-like plants with density approaching that of tall lawn grass.

Natural vegetative strips are any natural vegetative area through which sediment-laden flow is directed, including riparian vegetation around drainage channels. Flow is typically not broad overland sheet flow, but occurs in small concentrated flow channels or flow zones. These channels occur as a result of channelization resulting from the natural topography as well as a result of the deposition delta that frequently forms at the leading edge of the vegetation. Vegetation can range from grass-like plants to brush or trees with ground litter.

Riparian vegetative buffer strips are strips of vegetation that grow along stream and concentrated flow channels. The vegetation may be constructed or natural. To be effective, the VFS will normally be located on the contour perpendicular to the general direction of flow. A schematic of a typical VFS is given in Figure 5-1.

Historically, the primary purpose of a VFS was to enhance the quality of stormwater runoff on small sites in a treatment system approach, or as a pretreatment device for another BMP. The dense vegetative cover facilitates conventional pollutant removal through detention, filtration by vegetation, sediment deposition, and infiltration and adsorption in the soil (Yu and Kaighn, 1992). VFSs may be used as a pretreatment BMP in conjunction with a primary BMP. This reduces the sediment and particulate pollutant load that could be reaching the primary BMP, which, in turn, reduces the BMP's maintenance costs and enhances its pollutant removal capabilities.

More recent and developing use for the filter strip include: the use of a filter strip to reduce the impact of development on the hydrologic regime alterations of a site; addressing groundwater recharge concerns; reducing impacts to stream channel erosion; and controlling peak discharge for the 2-, 10- and 100-yr storms. Guidance for these methods was provided in Section 3. Figure 5-2 illustrates a mini-filter strip, in use at the Tampa Bay Aquarium parking lot to treat runoff, reduce peak discharge and recharge groundwater (Rushton, 2004).

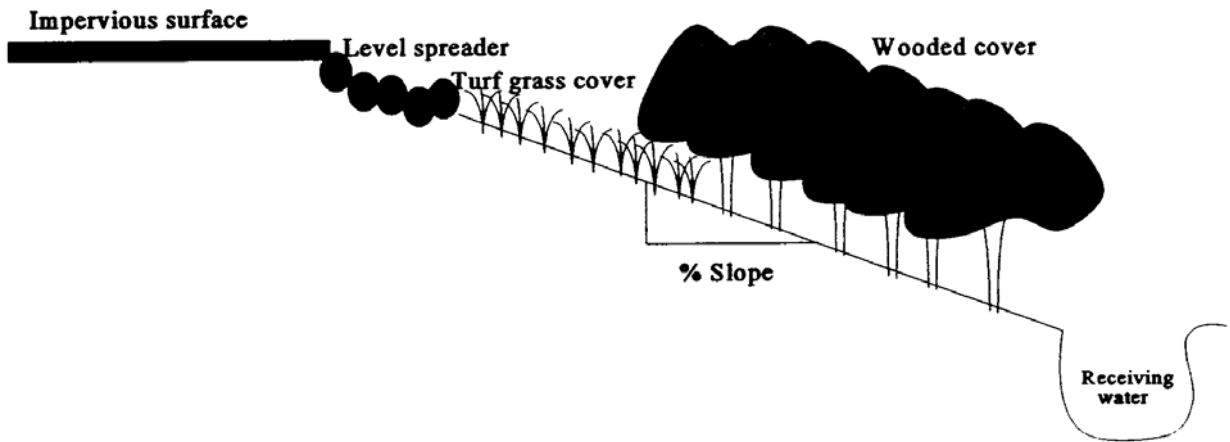

Figure 5-1 Conceptual Filter Strip (Indiana County Conservation District)



Figure 5-2 Parking Lot Filter Strip, Tampa Bay Aquarium (Rushton, 2004)

VFS have also been used in highway application along rural roadways where runoff that would otherwise discharge directly to a receiving water, passes through the filter strip before entering a conveyance system or a quality control facility (Washington State Department of Transportation, 1995). For example, runoff can be directed into a filter strip before it enters an infiltration trench. The filter strip removes particulates that could clog the infiltration trench, resulting in higher pollutant removal efficiencies and lower maintenance (Florida Department of Transportation, 1994).

Filter strips can be viewed as one component in an integrated SWM system. As such, they can lower runoff velocity, slightly reduce runoff volume, watershed imperviousness and contribute to groundwater recharge (Schueler, 1987). Filter strips have the aesthetic benefit of vegetated "open spaces" (Colorado Department of Transportation, 1992). They can preserve the character of riparian zones, prevent erosion along streambanks and provide excellent urban wildlife habitat (Schueler et al., 1992). Similar to grassed swales, filter strips can last indefinitely with proper conditions and regular maintenance. The performance of the VFS can be significantly diminished if uniform sheet flow and dense vegetation are not maintained.

Factors That Affect VFS Performance

The performance of a VFS is affected by a number of factors that include:

- < flow rate
- < drainage area
- < development conditions
- < soils
- < infiltration rate
- < topography
- < depth of water table
- < vegetation
- < climate
- < sediment characteristics
- < characteristics of chemicals being trapped.

Flow Rate and Drainage Area

The effectiveness of a VFS is inversely related to flow rate. A VFS should not receive large volumes of runoff since such flows tend to concentrate and form channels. Channels within a filter strip allow runoff to short-circuit the BMP, rendering it ineffective. Therefore, the contributing drainage area for a VFS is based on the linear distance behind it that is maintained as sheet flow. Runoff is assumed to change from sheet flow to shallow concentrated flow after traveling 300 ft over pervious surfaces for undeveloped areas (USDA, 1986). However, such flows are seldom, if ever, accomplished outside of laboratory conditions. Under natural conditions, casual observation will reveal that flows in a significant rainfall event are always a combination of some sheet flow and deeper more concentrated flows, even on parking lots. However, as runoff rates increase, the depths of flow in these concentrated flow areas increase. If possible, very large flow rates per unit width (flow rate over the width perpendicular to the direction of flow) should be avoided as these will produce a tendency to have concentrated flow channels of sufficient depth and velocity to short-circuit the BMP, reducing its effectiveness. The presence of these larger concentrated flows do not render the VFS totally ineffective in trapping sediment and chemicals, but simply reduce its effectiveness. The more significant problem is that the deeper flows can tend to start erosion and form incised channels, causing VFS failure. For urban areas the recommended values of overland flow are reduced to 150 ft over pervious surfaces and 75 ft over impervious surfaces (CRC, 1996 and MDE, 2000). A level spreader may be used to convert shallow concentrated flow from larger areas back to sheet flow before it enters the filter strip. This can be helpful in decreasing the impact of concentrated flows, but does not totally solve the problem. In any event, the contributing drainage area should be kept relatively small and a maximum limit of 5 acres has been suggested (CRC, 1996 and MDE, 2000). Analytical

procedures using the IDEAL presented in Section 4 are provided later in this section which computational procedures to derive these values.

Once in the filter strip, most runoff from significant events will not be infiltrated and will require a collection and conveyance system. Grass-lined swales are often used for this purpose and can provide another BMP level of treatment. A filter strip can also drain to a storm sewer or street gutter (UDFCD, 1999).

Development Conditions

VFSs have historically been used and proven successful on agricultural lands, primarily due to their low runoff volumes. In urban settings, filter strips are most effective in treating runoff from isolated impervious areas such as rooftops, small parking areas and other small impervious areas. Filter strips should not be used to control large impervious areas. Since VFSs should not be used to treat concentrated flows, they are best suited for low- to medium-density development (16-21% impervious). They can also be used as a pretreatment component for structural BMPs, or as part of a treatment train approach in higher density developments.

Soils and Infiltration Rate

VFSs should be used with soils having good infiltration rates in order to obtain optimum performance. Infiltration rates of 0.27 in/hr or higher are recommended (sandy loam, loamy sand, loam). Soils with lower infiltration rates can also be used but the width of the filter strip will increase. Soils should be capable of sustaining adequate stands of vegetation with minimal fertilization. The presence or incorporation of organic matter such as peat or leaf mulch in soils improves the ability of filter strips to remove pollutants from the surface runoff.

Topography

VFS performance is inversely related to slope for several reasons. First of all, velocity increases with increasing slope, causing a decrease in residence time within the VFS and a corresponding decrease in the opportunity for sediment to settle out. Topography should be relatively flat to maintain sheet flow conditions. Secondly, an increase in slope increases the bedload transport capacity of sediment in the filter, increasing the distance over which bedload is transported into the filter. Finally, the increase in slope results in increased shear force within the concentrated flow areas, causing an increased propensity for erosion and possible VFS failure.

Topography should be relatively flat to maintain sheet flow conditions. When filter strips are used on steep or unstable slopes, the formation of rills and gullies can disrupt sheet flow (UDFCD, 1999). As a result filter strips will not function at all on slopes greater than 15% and may have reduced effectiveness on slopes between 6 and 15%. Performance is best with longitudinal grades of 5% or less to maintain uniform sheet flow conditions (Washington State Department of Transportation, 1995), although VFS designs have been successful in steeper slopes ranging from 15 to 20% (Barfield and Hayes 1988). Rainfall patterns and intensity also play a role. A 15% slope in arid and semi-arid climates would result in erosion rills because of rainfall intensity, i.e., thunderstorms, and limited ground cover.

Depth of Water Table

A shallow or seasonally high groundwater table will inhibit the opportunity for infiltration. Therefore, the lowest elevation in the filter strip should be at least 2 ft above the mean high water table. If the soil's permeability and/or depth to water table are unsuitable for infiltration, the filter strip's primary function becomes the filtering and settling of pollutants. A modified design may be provided to allow ponding of the water quality volume at the filter's downstream end. The ponding area may be created by constructing a small permeable berm using a select soil mixture. The ponding depth behind the berm should be relatively small with recommended values of 6 to 12 in. Pollutant removal of the ponding area can be calculated by procedures given in Volume 3.

Vegetation and Climate

Filter strips function most effectively where the combination of vegetation, climate and soils permit year-round dense vegetation. They are not recommended in arid regions where vegetation in upland areas is sparse. Vegetation that grows in clumps tends to be less effective than uniform growth. Sediment trapping is directly related to the density of vegetation at the soil surface, stiffness and height of the vegetation. If the vegetation is not sufficiently stiff to remain erect under storm flow conditions, trapping will be greatly reduced as vegetation lays flat. They can function in regions with cold winters, but they may be ineffective in treating runoff during snowmelt conditions. Any type vegetation that does not have a dense network of vegetative stems at the soil surface will not be effective.

If the vegetation is too short, it can expose the underlying soil to erosion. In addition, most of the flow will occur over the top of the vegetation at high flow rates, greatly reducing trapping. Values for vegetative characteristics such as roughness, height, density and stiffness are summarized in Haan et al. (1994).

Pollutant Removal Capabilities

The pollutant removal mechanisms utilized in filter strips, vegetative filtration and soil infiltration, are similar to those employed in grassed swales. Under low to moderate velocity, filter strips effectively reduce particulate pollutant levels such as sediment, organic materials and trace metals (Schueler et al., 1992). Research in Florida demonstrated removal rates of 70% for TSS, 40% for phosphorus (particulate) and zinc, 25% for lead, and 10% for nitrate/nitrite (Florida Department of Transportation, 1994). Removal of soluble pollutants in filter strips is accomplished when pollutants infiltrate into the soil, some of which are subsequently taken up by rooted vegetation. Therefore, removal of solubles depends on the infiltration rates. However, this mechanism is minor in most filter strips since only a modest portion of the incoming runoff is infiltrated, resulting in low removal rates for solubles.

The rate of removal in filter strips is a function of length, slope, soil permeability, size of contributing runoff area, particle size and settling velocity, and runoff velocity (Schueler, 1987). A wide range of values for minimum length in the flow direction have been reported in the literature. Frequently cited values range from 6 m (20 ft), to lengths of 30 - 90 m (100 - 300 ft) for adequate removal of the smaller particulates. The design guidance that follows provides an analytical procedure for computing an appropriate length.

Regardless of vegetation type, the length of the filter strip is shown to have significant influence on pollutant removal. Figure 5-3 demonstrates percent pollutant removal efficiency versus length. In Figure 5-3, the relative value of adding additional length to a filter strip for pollutant removal levels off significantly after 18 m (59 ft), with the most significant rise in removal occurring between 6 and 18 m (19 and 59 ft). However, the final decision for strip length is not entirely dependent on the desired pollutant removal rate. The existing longitudinal slope will also influence the ultimate length of the system. These factors may dictate a strip longer than would be necessary if pollutant removal alone was the only consideration.

In design, the variables that can be effectively manipulated include length and slope of the strip, soil characteristics and vegetative cover. Optimum lengths are between 20 to 30 m (66 to 100 ft). Higher pollutant removal rates for longer lengths are feasible; however, further improvements in pollutant removal are relatively minor. The site considerations discussed in the section above, specifically natural slope and soil type, will also affect the pollutant removal performance of the biofilter. Avoiding the potential for concentrated flows and "gullies" will effectively "short-circuit" the filter strip and significantly reduce removal rates. Width can also influence pollutant removal but is often constrained by the area available.

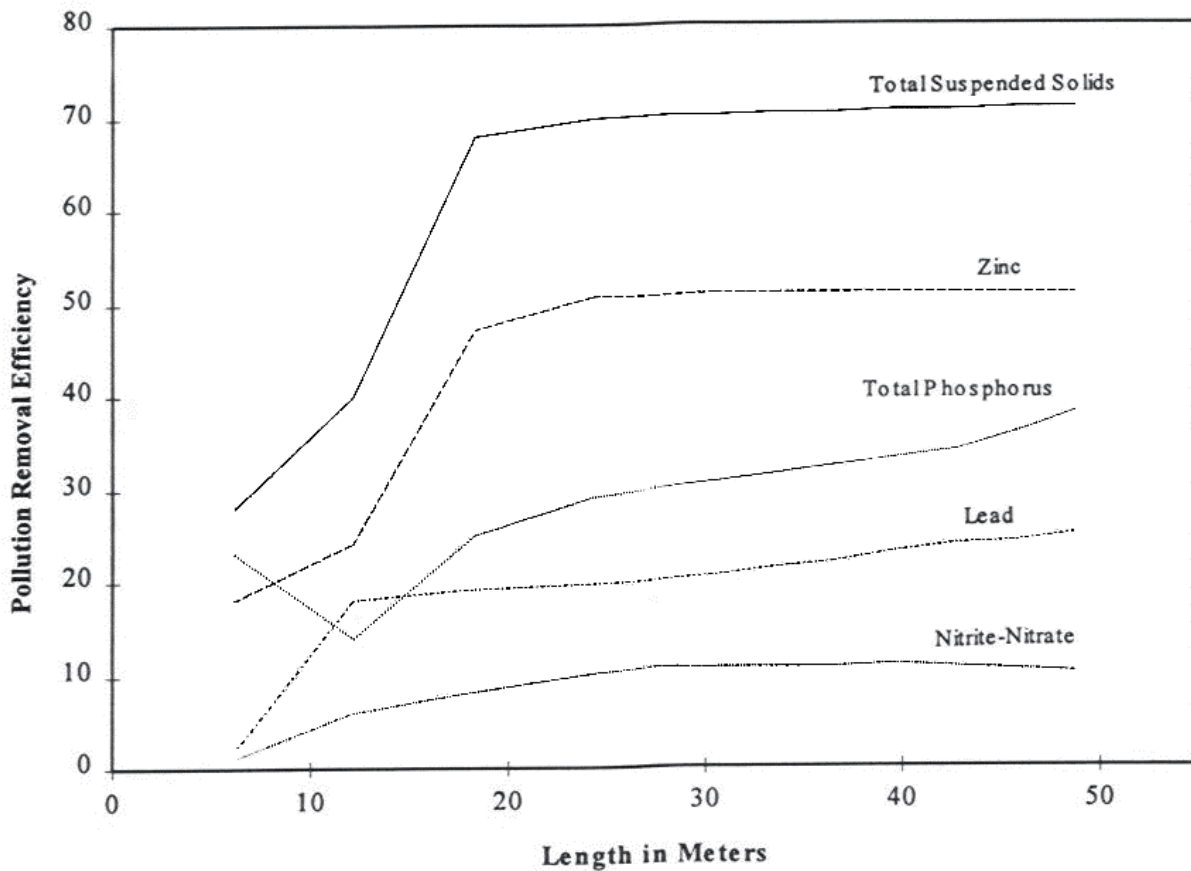

Figure 5-3 Pollutant Removal Efficiency Versus Filter Strip Length (Yu and Kaighn, 1992)

Design Guidance

A number of approaches for the sizing and design of VFS have been documented in the literature. A summary of selected approaches from different parts of the county that provide varying degrees of complexity and design robustness are presented below:

- design graph approach (Wong and McCuen, 1982)
- Maryland stormwater credit approach (MDE, 2000)
- Urban Drainage and Flood Control District approach for Denver region (UDFCD, 1999)
- IDEAL procedure (Hayes et al., 2001).

Due to regional and climatic differences of these approaches, the reader is advised to also seek out local guidance where appropriate.

Design Chart Procedure

The design chart procedure provides a method for determining VFS dimensions on vegetation, slope and desired sediment trapping efficiency. Although sediments are typically not the only pollutant of concern, the character of stormwater runoff (and highway runoff in particular) is such that the majority of the important classes of pollutants

including organics, nutrients, metals and bacteria, are present in particulate form, or are associated with particulate matter through adsorption processes (Florida Department of Transportation, 1994). Therefore, a filter strip designed to trap sediments will also accomplish some removal of other pollutant constituents.

Figure 5-4 was developed for coarse silt soil textures by Wong and McCuen (1982) for determining the required length of a grassed filter if the slope of the strip, roughness coefficient (Manning's *n*) and desired trapping efficiency are known (as cited in Yu and Kaighn, 1992). The dashed lines represent an example where slope is 2%, Manning's *n* is 0.20 and the desired trapping efficiency is 95% yielding a required strip length of 61 m (200 ft). It should be pointed out that Wong and McCuen's method is based on the following assumptions:

- Manning's equation with a constant roughness is valid using depth of flow as the hydraulic radius
 - one particle size can be used to represent all particles
 - infiltration is not significant.

All of these assumptions have been shown to be inappropriate except for a very limited number of sites by Hayes, et al. (1984). Further, the relationship has not been validated with field measurements. Attempts have been made to adjust for other soil textures, based on the dominant texture at the site. Table 5-1, developed by Young et al. (1996) and based on the data reported by Wong and McCuen (1982), provides multiplicative adjustment factors for the buffer strip length obtained from Figure 5-4 (Wong and McCuen, 1982). The basis on which these adjustments have been developed has not been identified.

Table 5-1 Multiplicative Adjustments in Length for Various Soil Type

Soil Type	Buffer Strip Length
Coarse Silt	Length from Figure 5-4
Fine Silt	4.9 x length from Figure 5-4
Medium Silt	1.3 x length from Figure 5-4
Fine Sand	0.02 x length from figure 5-4
Medium Sand	0.005 x length from figure 5-4

Appropriate swale length also depends on slope. A rule of thumb cited by many publications is 15 - 23 m (50 - 75 ft) plus an additional 1.2 m (4 ft) for each 1% of slope at the site (particularly if strip will be forested). For example, a 5% slope yields a range of acceptable lengths between 21 and 29 m (70 to 95 ft) through the computation 15 to 23 m + (5 x 1.2) m (Schueler et al., 1992). This criteria can be used to compare length derived from the design chart method shown in Figure 5-4.

Wong and McCuen state that the data in Figure 5-4 is the graphical solution to the equation developed by Tollner et al. (1976) for a coarse silt soil texture with a mean settling velocity of 0.002 ft/s through a buffer strip with an average spacing hydraulic radius of 0.010 ft. The trapping efficiency for other soil textures can be determined using trap efficiencies that are attainable using buffer strips for a particular particle size. For example, since the ratio of the settling velocities for a coarse silt and a fine silt is 4.9, the buffer length obtained from Figure 5-4 should be multiplied by this ratio (4.9) to obtain the buffer strip length for a fine silt. This would then provide the same trapping efficiency indicated on Figure 5-4. The settling velocity ratio of coarse silt to medium silt, fine sands and medium sands are reported as 1.3, 0.02 and 0.005 respectively, which form the basis for the values in Table 5-1.

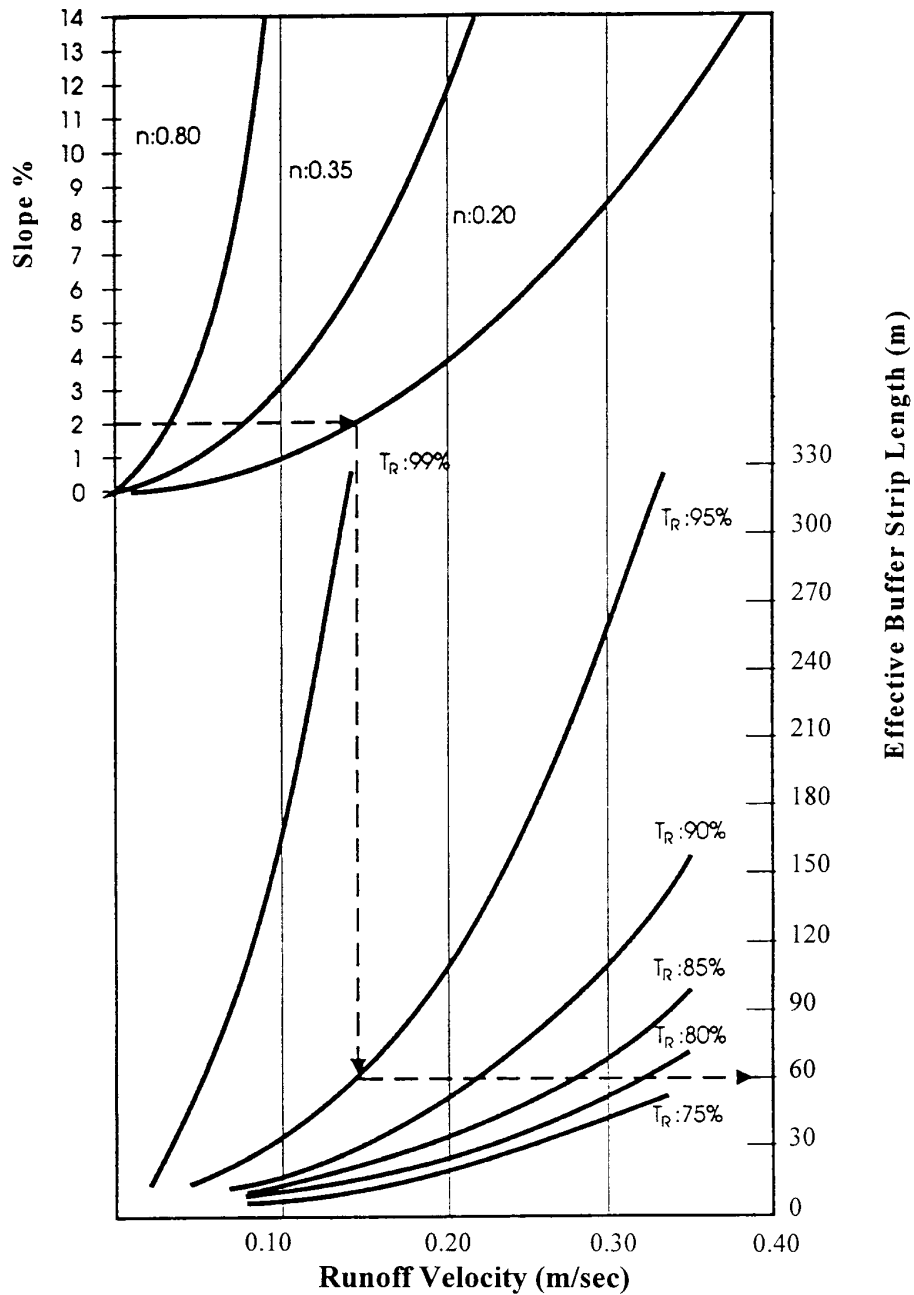

Figure 5-4 Removal rates (TR) for Buffer Strips (Wong and McCuen, 1982) (Reprinted with Permission of ASCE)

There are some significant limitations to design chart method as it does not take into account the particle size of the material or the infiltration rate of the soils. Consequently it over predicts trapping efficiency of soils with low permeability and under predicts trapping efficiency of soils with high permeability. For these reasons, the design

chart method is limited as a predictive design tool and should be used only where the assumptions on which the method is based on are valid. The limitations of this approach are addressed in the IDEAL approach presented in this section; IDEAL can also be used to generate accurate charts of this type.

The Maryland Stormwater Credit Approach

As described in Volume 1, the State of Maryland (MDE, 2000) has incorporated a number of SWM credits that include a series of non-structural BMPs that can be incorporated into the design of a SWM plan. One of these credits consists of a VFS or buffer and is referred to as “The Sheetflow to Buffer Credit.” This non-structural BMP is shown in Figure 5-5.

This credit is given when stormwater runoff is effectively treated by a natural buffer to a stream or forested area. Effective treatment is achieved when pervious and impervious area runoff is discharged to a grass or forested buffer through overland flow. The use of a filter strip is also recommended to treat overland flow in the green space of a development site.

The design credits allocated to this practice include:

1. The area draining by sheet flow to a buffer is subtracted from the total site area in the water quality volume (V_{wq}) calculation.
2. The area draining to the buffer contributes to the groundwater recharge requirement (Re_v).
3. A *wooded CN* can be used for the contributing area if it drains to a forested buffer.

Criteria for Sheetflow to Buffer Credit

The credit is subject to the following conditions:

- The minimum buffer width must be 50 ft as measured from bankfull elevation or centerline of the buffer.
- The maximum contributing length has a maximum limit of 150 ft for pervious surfaces and 75 ft for impervious surfaces.
- Runoff must enter the buffer as sheet flow. Either the average contributing overland slope shall be 5.0% or less, or a level spreading device shall be used where sheet flow can no longer be maintained.
- Buffers must remain unmanaged (other than routine debris removal) and must be located within an acceptable conservation easement or other enforceable instrument that ensures perpetual protection of the proposed area. The easement must clearly specify how the natural area vegetation shall be managed and boundaries will be marked [Note: managed turf (e.g., playgrounds, regularly maintained open areas) is not an acceptable form of vegetation management].

The Maryland stormwater credit approach is a valid regulatory approach; however, it must be observed that as a design approach it is subject to the same significant limitations as the previous methods. It does not take into account the particle size of the material or the infiltration rate of the soils. It will also over predict trapping efficiency of soils with low permeability and under predict the trapping efficiency of soils with high permeability. For these reasons this method should not be used as a predictive design tool and should be used with caution. The limitations of this approach are addressed in the IDEAL design approach presented in this section, which can also be used to generate and verify simplified design criteria.

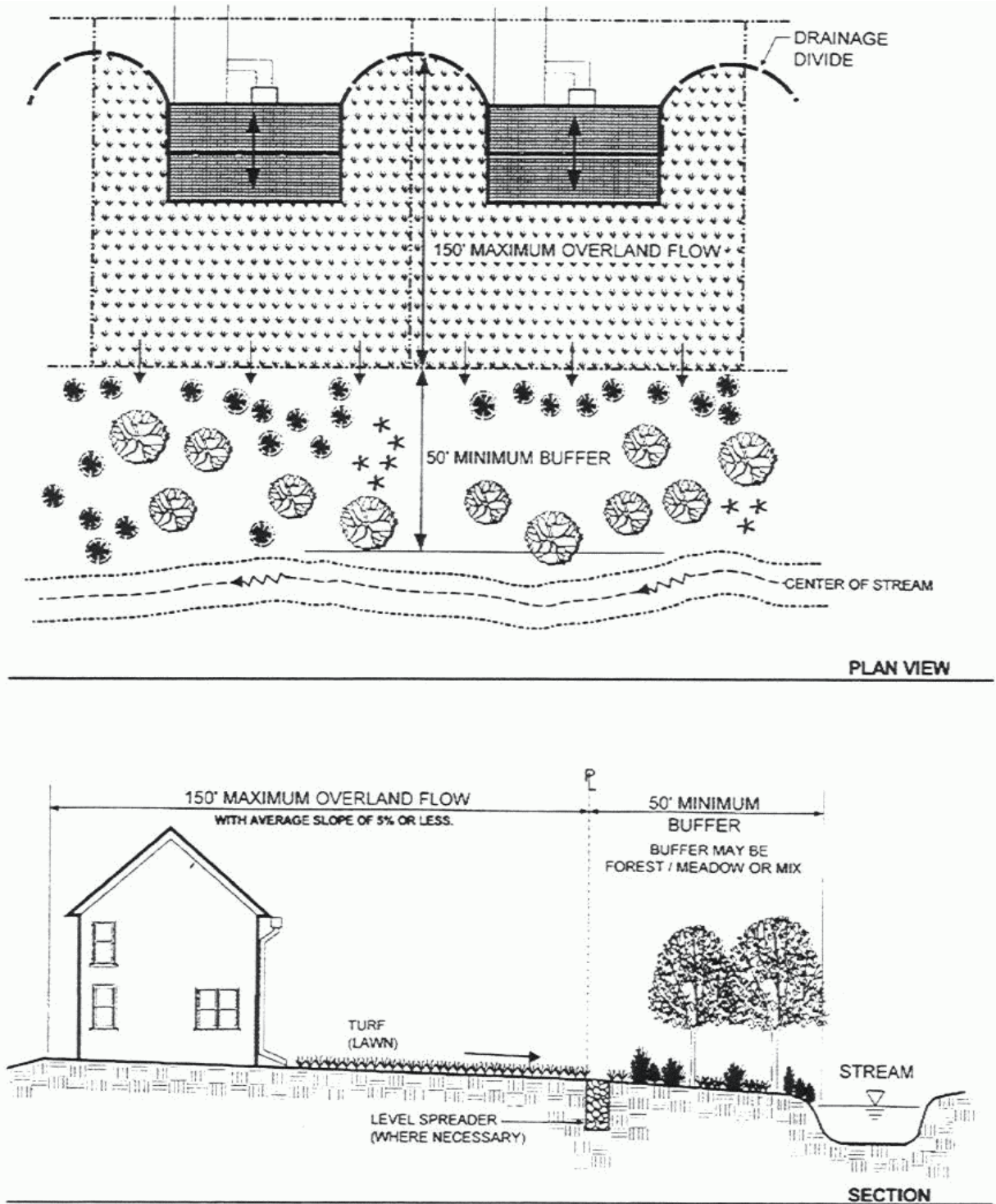

Figure 5-5 Maryland Buffer Strip (MDE, 2000)

Urban Drainage and Flood Control District Procedure for Denver Region

The Denver Urban Drainage and Flood Control District has included a design procedure for the use of a grass buffer, as shown in Figure 5-6 in its Urban Stormwater Drainage Criteria Manual (UDFCD, 1999). The following steps outline the grass buffer design procedure and criteria. Figure 5-7 is a schematic of the facility and its components.

Step1: Design Discharge

Determine the 2-yr peak flow rate of the area draining to the grass buffer. Also, determine the flow control type, sheet or concentrated.



Figure 5-6 Grass Buffer (UDFCD, 1999)

Step 2: Minimum Length

Calculate the minimum length (normal to flow) of the grass buffer. The upstream flow needs to be uniformly distributed over this length. General guidance suggests that the hydraulic load should not exceed 0.05 cfs/ft of buffer in the Colorado high plains region during a 2-yr storm to maintain a sheet flow of less than 1 in. throughout dense grass that is at least 2 in. high. The minimum design length (normal to flow) is therefore calculated as:

$$L_G = Q_{2-yr} / 0.05 \quad (5-1)$$

where: L_G = minimum design length (ft), and

Q_{2-yr} = peak discharge supplied to the grass buffer by a 2-yr event (cfs).

It should be noted that longer lengths may be used if desired.

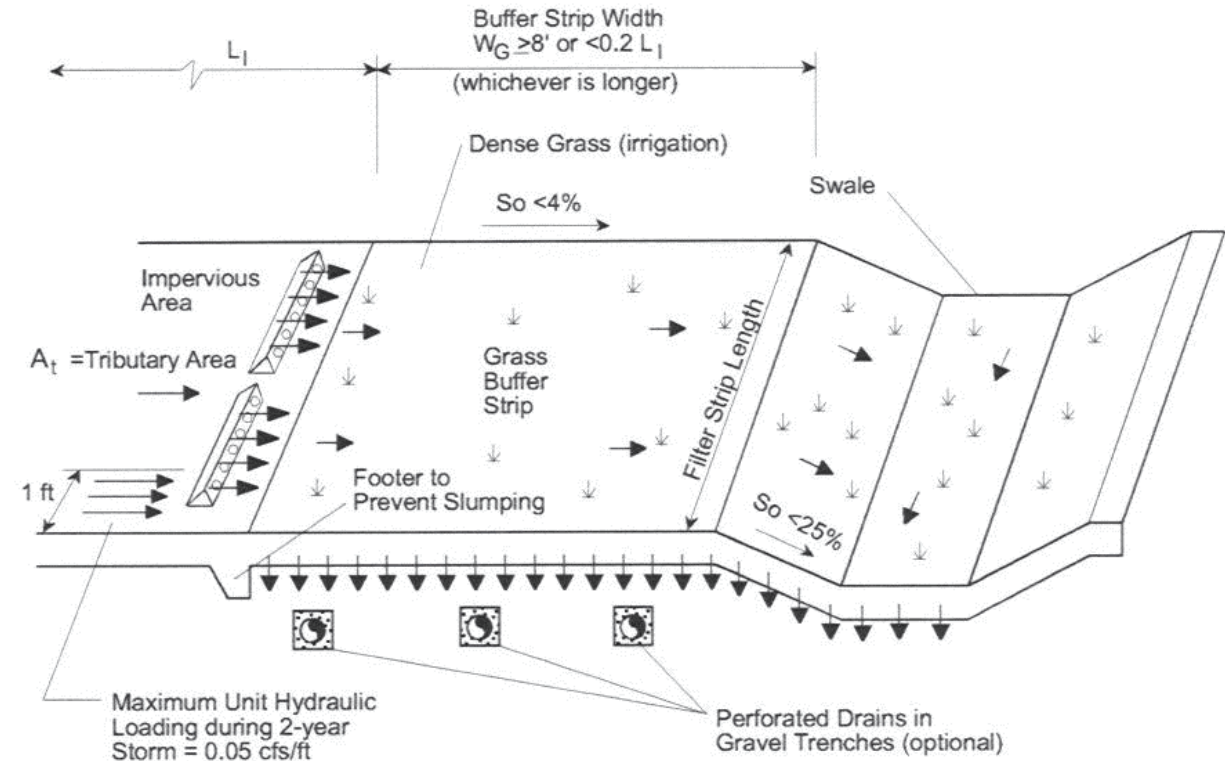

SHEET FLOW CONTROL

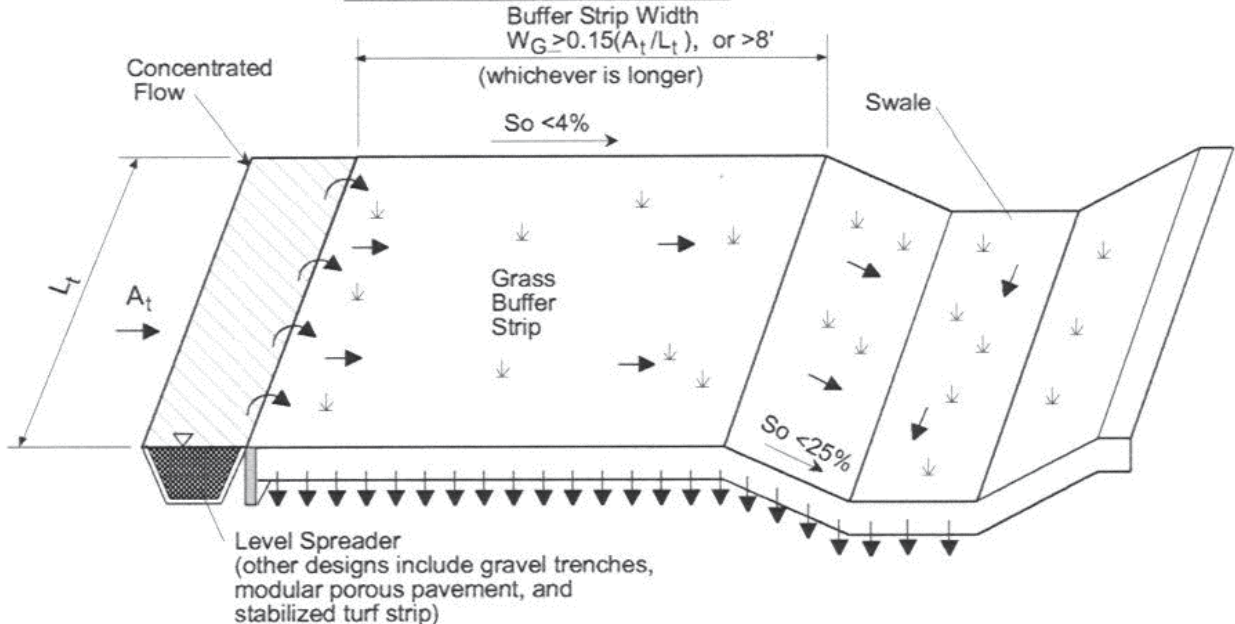

CONCENTRATED FLOW CONTROL

Figure 5-7 UDFCD Grass Buffer Schematic (UDFCD, 1999)

Step 3: Minimum Width

The minimum width, W_G , the distance along the sheet flow direction of the grass buffer shall be determined by the following criteria for onsite and concentrated flow control conditions:

A. Sheet Flow Control (use the larger value)

$$W_G = 0.2L_f \text{ or } 8 \text{ ft} \quad (5-2)$$

where: L_f = length of flow path of sheet flow over the upstream impervious surface in ft.

B. Concentrated Flow Control (use the larger value)

$$W_G = 0.15 (A_t / L_t) \text{ or } 8 \text{ ft} \quad (5-3)$$

where: A_t = the tributary area in ft², and

L_t = the length of the tributary (normal to flow) upstream of the grass buffer in ft.

It should be noted that the longer the buffer area is relative to the impervious area draining to it, the smaller the effective imperviousness. A generally rectangular shape strip is preferred and should be free of gullies or rills that concentrate the overland flow.

Step 4: Maximum Slope

Design slopes shall not exceed 4%.

Step 5: Flow Distribution

Incorporate a device on the upstream end of the buffer to evenly distribute flows along the design length. Slotted curbing, modular block porous pavement, or other spreader devices can be used to apply flows. Concentrated flow supplied to the VFS must use a level spreader (or a similar concept) to evenly distribute flow onto the buffer.

Step 6: Vegetation

Vegetate the grass buffer with irrigated dense turf in semi-arid areas of Colorado to promote sedimentation and entrapment and to protect against erosion.

Step 7: Outflow Collection

Provide a means for outflow collection. Most of the runoff during significant events will not be infiltrated and will require a collection and conveyance system. A grass swale can be used for this purpose in a treatment train. The buffer can also drain to a storm sewer or to a street gutter.

Design Example

The UDFCD has developed a series of simplified design forms that provide a uniform means of documenting the design procedure. A completed form follows as a design example.

Grass Buffer Design Procedure Form (UDFCD, 1999)	
Company: _____	Designer: _____
Project: _____	Date: _____
Location: _____	
1. 2-Year Design Storm	$Q_2 = \underline{5.0}$ cfs
2. Tributary Catchment Flow A) Design Length:(Normal to runoff flow path) $L_G = Q_2 / 0.05$ B) Tributary Area in Square Feet (A_T)	$L_G = \underline{100}$ feet $A_T = \underline{10,000}$ square feet
3. Design Width Along Direction of Flow (Use A or B) A) Sheet Flow Control Upstream i) Length of Flow Path Over Upstream Impervious Surface ii) Design Width of Buffer: $W_G = 0.2 * L_I$ (8' minimum) B) Concentrated (Non-Sheet) Flow Control Upstream (Requires a level spreader in step 5 below) i) Length of Upstream Flow Level Spreader ii) Design Width of Buffer: $W_G = 0.15 * A_T / L_T$ (8' minimum)	$L_I = \underline{\hspace{2cm}}$ feet $W_G = \underline{\hspace{2cm}}$ feet $L_I = \underline{100}$ feet $W_G = \underline{15.0}$ feet
4. Design Slope (not to exceed 4%)	$S = \underline{\hspace{2cm}}$ feet
5. Flow Distribution (Check the type used or describe "Other") Note: If Method B was used in Step 3, Level Spreader Must Be Checked Here	<input type="checkbox"/> Slotted Curbing <input type="checkbox"/> Modular Block Porous Pavement <input checked="" type="checkbox"/> Level Spreader <input type="checkbox"/> Other _____
6. Vegetation (Check the type used or describe "other") Note: Irrigated Turf Grass is Required in Semi-Arid Climates	<input checked="" type="checkbox"/> Irrigated Turf Grass <input type="checkbox"/> Non-Irrigated Turf Grass <input type="checkbox"/> Other _____
7. Outflow Collection (Check the type used or describe "other")	<input checked="" type="checkbox"/> Grass Swale <input type="checkbox"/> Street Gutter <input type="checkbox"/> Storm Sewer Inlet <input checked="" type="checkbox"/> Underdrain Used <input type="checkbox"/> Other _____
Notes: _____ _____ _____	

This procedure was developed with the aid of local government and engineers in and for the Colorado High Plains environment. It was designed to provide an easy to follow protocol for a particular region of the country. As such, it can be observed that this design approach is also subject to the same significant limitations as the previous methods. It does not take into account site specific criteria like the particle size of the material or the infiltration rate of the soils. It will also over estimate the trapping efficiency of soils with low permeability and under estimate the trapping efficiency of soils with high permeability. For these reasons, this and the other methods listed above are limited as a regional predictive design tools and should not be used outside the region for which the original design guidance was intended.

IDEAL Analysis Procedures for Vegetative Biofilters

The IDEAL spreadsheet tool provides a scientifically robust analytical procedure for the design of vegetative biofilters (Hayes et al., 2001). This procedure builds upon the earlier work on the design of VFS by Barfield and Hayes (1988), Hayes et al. (1984) and Haan et al. (1994). Routines involved in computing the effectiveness of vegetative biofilters ifor both VFS and grassed swales include hydraulic routing, sediment routing and nutrient/pollutant routing. Each of these are discussed for VFS and grassed swales along with information on inputs.

IDEAL is a relatively complex procedure compared to the design approaches described above and many regulatory agencies at the State and local level may not want to require this degree of complexity in every BMP design. However, the method can also be used to verify the accuracy of simpler design charts or methods, and can also be useful to evaluate the cumulative effectiveness of BMP practices at the watershed scale.

Hydraulic Routing in Grassed Swales and Vegetative Filters

Volume Routing

Routing of flow volume through the filter involves determining the infiltration volume and subtracting that from inflow volume to obtain outflow volume. Although infiltration rate varies during a storm, a first approximation can be made by assuming a constant rate, as shown in Table 5-2. To determine infiltration volume, flow duration through the filter must be known and can be approximated by using a triangular hydrograph assumption. With this approximation along with peak inflow rate and runoff volume, the hydrograph time base (storm flow time) becomes:

$$t_b = \frac{2QA}{q_p} \text{Const}_5 \tag{5-4}$$

where: t_b = hydrograph time base in hr,
 Q = watershed runoff volume in cm (in.),
 A = watershed area in ha (acre),
 q_p = peak discharge in m³/s (ft³/s) flowing into the filter, and
 Const_5 = 2.78x10⁻² for metric units and 1.008 for English units.

The potential infiltration volume in a filter is then:

$$V_{inf} = i_r t_b \tag{5-5}$$

where: i_r = infiltration rate in cm/hr (in/hr) from Table 5-2.

Equation 5.5 predicts the volume of water that infiltrates and carries chemicals and sediment with it into the soil matrix.

Table 5-2 Steady-State Infiltration Rates for Analyzing Vegetative Filter Strips and Grass Swales (Terstriep and Stall, 1974)

Hydrologic Soil Group	Vegetative Cover	Infiltration Rate ^a	
		in/hr	cm/h
A	Turf	1 - 10	2.5 - 25
B	Turf	0.5 - 8	1.3 - 20.3
C	Turf	0.25 - 5	0.6 - 12.7
D	Turf	0.01 - 3	0.25 - 7.6

^aValues shown are the expected range of infiltration rates. The high value is the initial infiltration rate and the low value is the final infiltration rate in a storm. Since infiltration rates decay rather rapidly, the larger values should be reserved only for very short duration storms and even then used with caution. The conservative approach would be to tend toward the lower values.

The impact of rain falling directly on a filter must also be accounted for in the calculation of the potential infiltration volume. This impact on the volume, $V_{inf-prec}$, can be accounted for by subtracting the average precipitation rate, P , in cm/hr (in/hr) from the infiltration rate, i_r , in equation 5.5 to obtain:

$$V_{inf-prec} = \left(i_r - \frac{dP}{dt} \right) t_b \quad (5-6)$$

where: dP/dt = precipitation rate.

A first estimate of precipitation rate would be to divide rainfall amount by time base defined in equation 5.4. Although the actual duration of rainfall is greater than t_b , average intensities during runoff will be better represented by using t_b , than the actual duration of rainfall. The runoff volume from the watershed, Q , and the corrected infiltration volume of the filter, as defined by equation 5-6, are then used to predict outflow rate from the VFS. Outflow volume, Q_o , in cm (in.) is:

$$Q_o = \frac{QA - V_{inf-prec} A_f}{A + A_f} \quad (5-7)$$

where: A_f = area of the filter in ha (acre).

Peak outflow, q_{po} , rate is:

$$q_{po} = q_p \frac{Q_o}{Q} \quad (5-8)$$

Equation 5-8 is based on the assumption that the time base of the hydrograph does not change during the flow through the VFS. Average flow rate, q_a (m³/s or ft³/s) through the filter is given by:

$$q_a = \frac{q_p + q_{po}}{2} \quad (5-9)$$

This average value is used to determine flow velocity, which is required to compute sediment transport and settling in the filter strip or grass swale.

Flow Velocities

The impact of a grass swale or VFS depends on whether or not the vegetation is submerged. Two approaches to calculating hydraulics are given. For VFS, it is assumed that depth of flow does not exceed height of vegetation and that the cross-section is a wide rectangular shape with uniform sheet flow. For grass swales, a wide variety of shapes can be utilized and flow may or may not be submerged.

Vegetative Filter Strips

In calculations of velocity for VFS, discharge per unit width is used as defined by:

$$q_w = q_a / W \quad (5-10)$$

where: q_w = flow rate per unit width in $m^3/s\text{-m}$ ($ft^3/s\text{-ft}$), and
 W = width of the filter perpendicular to the mean flow direction in m (ft).

Using an analogy of flow through a rectangular channel with a width equal to grass spacing, the hydraulic radius of Manning's equation can be defined as R_s and calculated by:

$$R_s = \frac{d_f S_s}{S_s + 2d_f} \quad (5-11)$$

where: R_s = spacing hydraulic radius in m (ft),
 d_f = is flow depth in m (ft), and
 S_s = spacing of grass media in m (ft).

The flow, q_w , can now be translated into a flow depth through Manning's equation and continuity, or:

$$q_w = d_f V = \frac{Const_6}{n} d_f R_s^{2/3} S^{1/2} = \frac{Const_6}{n} d_f \left[\frac{d_f S_s}{S_s + 2d_f} \right]^{2/3} S^{1/2} \quad (5-12)$$

where: V = velocity in m/s (ft/s),
 n = calibrated Manning's roughness for each vegetative type, and
 $Const_6$ = 1.0 for metric and 1.49 for English units.

Values for n and S_s are given in Table 5-3. W , S_s and n are input parameters for each VFS. Since equation 5-12 is implicit in d_f , a trial and error solution is required.

Parameters needed for hydraulic routing are:

S_s = spacing of the grass media,
 n = Manning's roughness,
 S = slope of the filter,
 i_r = infiltration rate, and
Retardance class.

Retardance class defines the stiffness of the grass and change in roughness as the depth increases based on the work of Ree (1949); values are provided in Table 5-4 and Figure 5-9. For additional information and sources for all these

parameters consult Haan et al. (1994) (Table 9.10). No other input values are needed to do sediment or pollutant routing.

Table 5-3 Hydraulic Input Information for Vegetative Filters

Vegetation	Retardance Class ^a Unmowed/ Mowed	Spacing (S_s) (in)	Calibrated Manning's n	Stiffness MEI Unmowed/Mowed N/m ²	Type Stand
Tall Fescue	B/D	0.63	0.056	20/0.1	Good
Ryegrass	B/D	0.67	0.056	20/0.1	Good
Bermudagrass	B&C/D	0.54	0.074	9/0.1	Good
Bluegrass	C/D	0.64	0.056	5/0.1	Good
Buffalograss	D/D	0.60	0.056	0.1/0.1	Good

Velocity equations presented above are only valid if the vegetation remains erect. Erectness of vegetation can be evaluated by two relationships presented by Kouwen et al. (1981), based on the shear velocity **U*** in m/s (ft/s) and grass stiffness **MEI** in N/m². Actual shear velocity is given by:

$$U^* = \sqrt{gd_f S} \tag{5-13}$$

where: **g** = gravity, 9.81 m/s² (32.2 ft/s²).

Kouwen et al. (1981) presented two relationships to predict critical shear velocity:

$$U_{c1}^* = Const_3 \left[0.091 + 20.76 (MEI)^2 \right] \tag{5-14}$$

and

$$U_{c2}^* = Const_3 \left[0.754 (MEI)^{0.106} \right] \tag{5-15}$$

where: **U_{c1}*** = critical shear of elastic grass in m/s (ft/s),
U_{c2}* = critical shear velocity of stiff grass in m/s (ft/s), and
Const₃ = 0.3048 for metric system and 1.0 for English units.

The minimum of the two is compared to actual shear velocity. If actual shear velocity is greater than the minimum, the grass will not remain erect. If the grass would not remain erect, the design flow velocity would need to be decreased by making the filter strip wider.

Grass Swales

Velocities for grass swales are calculated with Manning's equation, but the characteristic dimension now becomes the classic hydraulic radius. The velocity is now calculated by:

$$V = \frac{Const_6}{n} R^{2/3} S^{1/2} \tag{5-16}$$

where: **V** = average velocity in the swale in m/s (ft/s),
S = channel slope,

n = Manning's roughness, and
 R = hydraulic radius in m (ft).

Further, R of the swale is defined as:

$$R = A/P \tag{5-17}$$

where: A = cross sectional area of swale in m^2 (ft^2), and
 P = wetted perimeter of swale in m (ft).

Standard cross sections are given in Figure 5-8. Mannings n values are not constant, but vary widely with depth of flow as shown in Figure 5-9. Based on data taken in vegetated waterways of varying cross section and types of vegetation, Ree (1949) grouped vegetated channels into retardance classes A through E shown in Figure 5-9. In each of these retardance classes, Manning's n is shown as a function of product of velocity V in ft/s and hydraulic radius R in ft. Conversion must be made from other units to English units to use these curves. Using these curves, Ree (1949) developed nomographs for solving Manning's equation for each retardance class. An example is shown in Figure 5-10 (3.5) for Retardance class C. Nomographs for other retardance classes are given in Haan et al. (1994). Grass is classified according to retardance classes in Table 5-3.

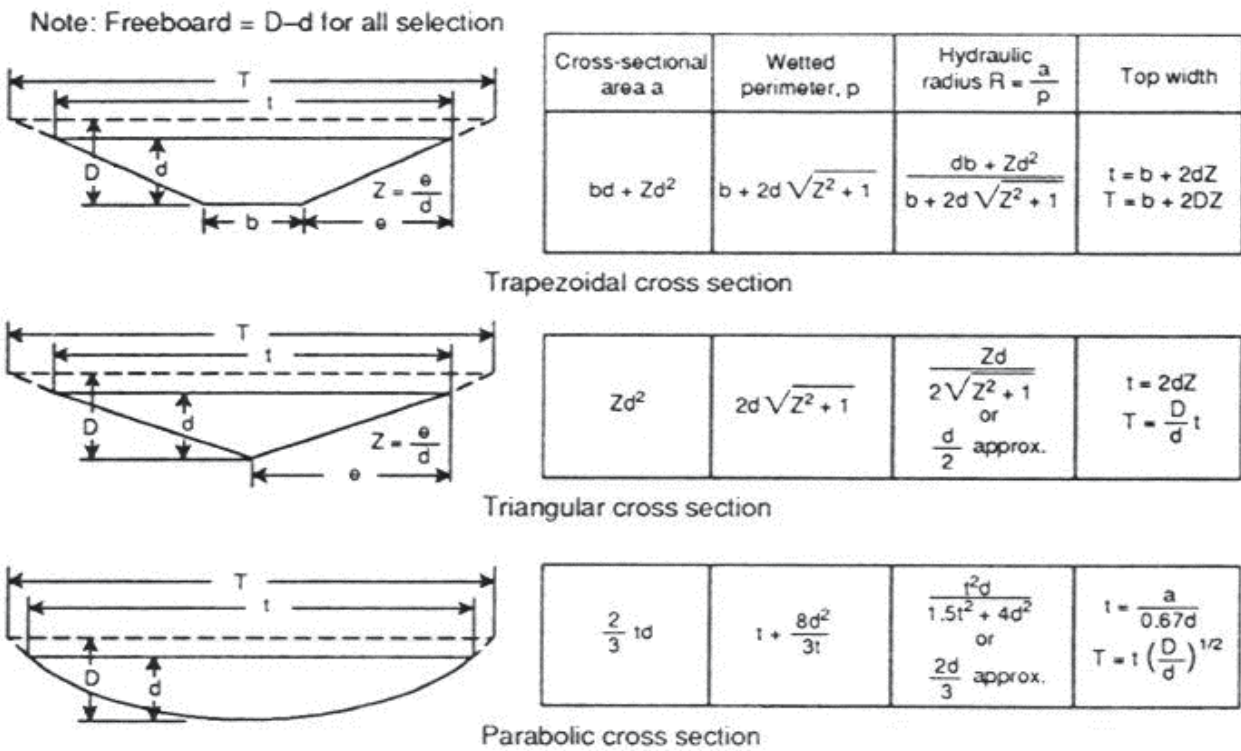

Figure 5-8 Standard Definitions of Channel Parameters (Haan et al., 1994)

Temple et al. (1987) developed the following approximation for the n - VR curves of Figure 5-9:

$$n = \exp \left[1 \left(0.01329 \{ \ln(VR) \}^2 - 0.09543 \ln \{ VR \} + 0.2971 \right) - 4.16 \right] \tag{5-18}$$

where: I = index of Retardance class.

The value for I as a function of Retardance class is given in Table 5-4.

Table 5-4 Values of index, I , for Equation 5-18

Retardance Class	I
A	10.000
B	7.643
C	5.601
D	4.436
E	2.876

Nomographs for other retardance classes are given in Haan et al. (1994). When designing grass swales for stability and flow conveyance capacity, the following steps should be taken (Haan et al., 1994).

Design for stability. Select a channel cross section and design for stability, using permissible velocities for vegetated channels from Table 5-5. Assume a mowed condition and select a channel with sufficient capacity to convey the flow and keep the velocity below the values given in Table 5-5.

Design for capacity. Assume that vegetation is unmowed, which will make the channel rougher and reduce the velocity. While maintaining the original cross section for the mowed condition, add sufficient area above the original design to convey the flow while in an unmowed condition.

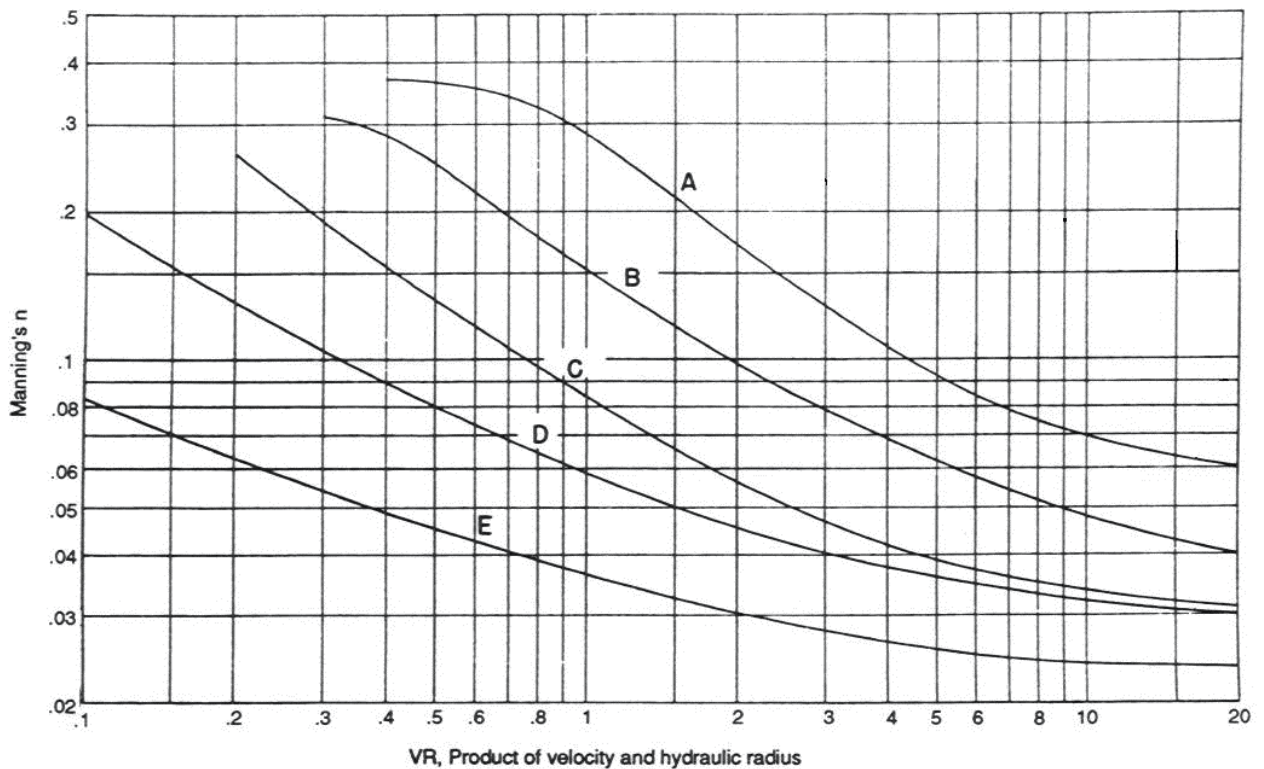

Figure 5-9 Manning's n Versus VR for Various Retardance Classes (Haan et al., 1994)

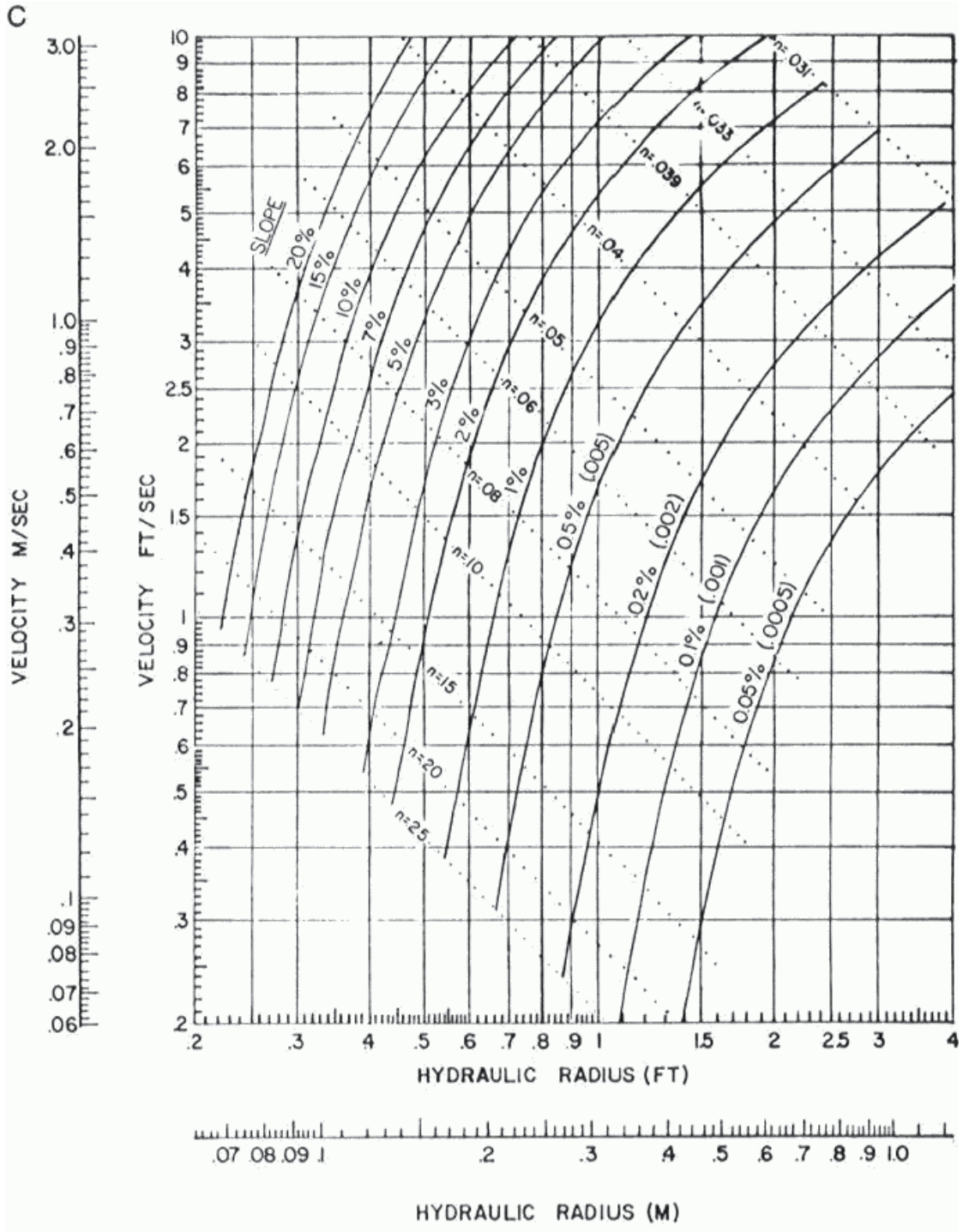

Figure 5-10 Solution to Manning's Equation for Retardance Class C (Haan et al., 1994)

Table 5-5 Permissible Velocities (ft/s) for Grass Swales

Soil Texture	Bare Channel Velocities (ft/s)	Channel Velocity (ft/s)			
		Retardance Class	Vegetation Condition		
			Poor	Fair	Good
Sand, silt, sandy loam, silty loam	1.5	B	1.5	3	4.0
		C	1.5	2.5	3.5
		D	1.5	2.0	3.0
Silty clay loam, sandy clay loam	2	B	2.5	4.0	5.0
		C	2.5	3.5	4.5
		D	2.5	3.0	4.0
Clay	2.5	B	3.0	5.0	6.0
		C	3.0	4.5	5.5
		D	3.0	4.0	5.0

USDA (1979) Engineering Field Manual

Sediment Routing

Sediment can be trapped in VFS and grass swales by two mechanisms; settling to the bottom and being carried into the soil matrix with infiltrating water.

Trapping efficiencies can be calculated in a similar manner for VFS and bioswales, but the characteristic dimensions are different.

Vegetative Filter Strips

Sediment in VFS is trapped by settling as well as by infiltration of sediment into the soil matrix. Theoretically, the mass of sediment trapped on each incremental area within the VFS in kg (lb), m_T , is given by:

$$m_T = m_{T,set} + m_{T,inf} = (\gamma V_s C_{sfc} + \gamma i_r C_{sfc}) 10^{-6} \quad (5-19)$$

where: $m_{T,set}$ = mass rate of sediment being trapped by settling in kg/s (lb/s),
 $m_{T,inf}$ = mass rate of sediment being trapped by infiltration in kg/s (lb/s),
 γ = density of water, 1000 kg/m³, in metric units or specific gravity 62.4 lb/ft³, in units,
 V_s = settling velocity in m/s (ft/s), and
 C_{sfc} = the concentration at the ground surface in mg/l (ppm).

If this is taken as an average over the filter and runoff duration and multiplied by the storm time base, the total mass trapped becomes:

$$M_T = M_{T,set} + M_{T,inf} = \left[(\gamma V_s C_{sfc,a} A_f + \gamma i_r C_{sfc,a} A_f) 10^{-6} \right] t_b \quad (5-20)$$

where: M = refers to total storm value mass in kg (lb), and
 $C_{sfc,a}$ = the concentration at the ground surface in mg/l (ppm) and the extra subscript, a , refers to an average value over time and space.

Unfortunately, $C_{sfc,a}$ is not known, only inflow concentration is known. In addition, inflow concentration is an average across the flow depth, not the surface concentration. Fortunately, the value for $M_{T,set}$ can be predicted well by

the Kentucky Grassfil model (Hayes et al., 1984). The relationship is based on the assumption that trapping efficiency due to settling, T_r , for a given particle class with settling velocity V_s is proportional to the number of times a particle can settle to the bottom as it flows through the filter and inversely proportional to the Reynolds number, or:

$$T_r = \exp[-0.00105 Re^{0.82} N_f^{-0.91}] \quad (5-21)$$

where: T_r = trapping efficiency due to settling,

Re = Reynolds number, and

N_f = number of times a particle can settle from water surface to the bottom as it travels through the filter.

Re is given by:

$$Re = \frac{VR_s}{\nu} \quad (5-22)$$

where: ν = kinematic viscosity in m²/s (ft²/s).

The parameter, N_f , is equal to the time to travel through the filter divided by the time to settle to the bottom of the filter, or:

$$N_f = \frac{L_f/V}{d_f/V_s} \quad (5-23)$$

where: L_f = filter flow length in m (ft).

A plot of the relationship along with the data is shown in Figure 5-11. Also shown are the results of field studies by Hayes et al. (1984), showing that the Kentucky Grassfil model accurately predicts effluent concentrations and trapping efficiencies.

An estimate can be made of the surface concentration in equation 5-19 by assuming that equation 5-20 correctly defines trapping by settling. The ratio of the mass being trapped versus the mass available to be trapped is the trapping efficiency or fraction trapped due to settling for a given particle size, i , is:

$$T_{r,i} = \frac{M_{T,set,i}}{Y_{T,i}} = \frac{10^{-6} \gamma V_{s,i} C_{sfc,a} A_f t_b}{Y_{T,i}} \quad (5-24)$$

where: $Y_{T,i}$ = total yield for particle class kb (lb), defined by equation 4.31.

Solving for the average surface concentration:

$$C_{sfc,a,i} = \frac{T_{r,i} Y_{T,i}}{10^{-6} \gamma V_{s,i} A_f t_b} \quad (5-25)$$

Thus, the total mass trapped as defined by equation 5-20 becomes:

$$M_T = Y_{T,i} T_{r,i} + M_{T,inf} = Y_{T,i} T_{r,i} + \gamma i_r \frac{T_{r,i} Y_{T,i} A_f 10^{-6}}{10^{-6} \gamma V_{s,i} A_f t_b} t_b \quad (5-26)$$

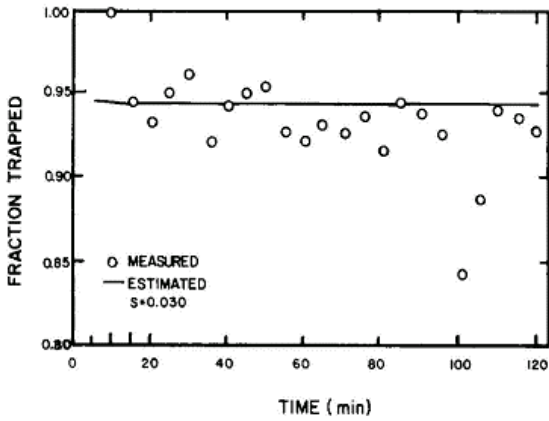

Field Test No. 1, Hayes et al. (1984)

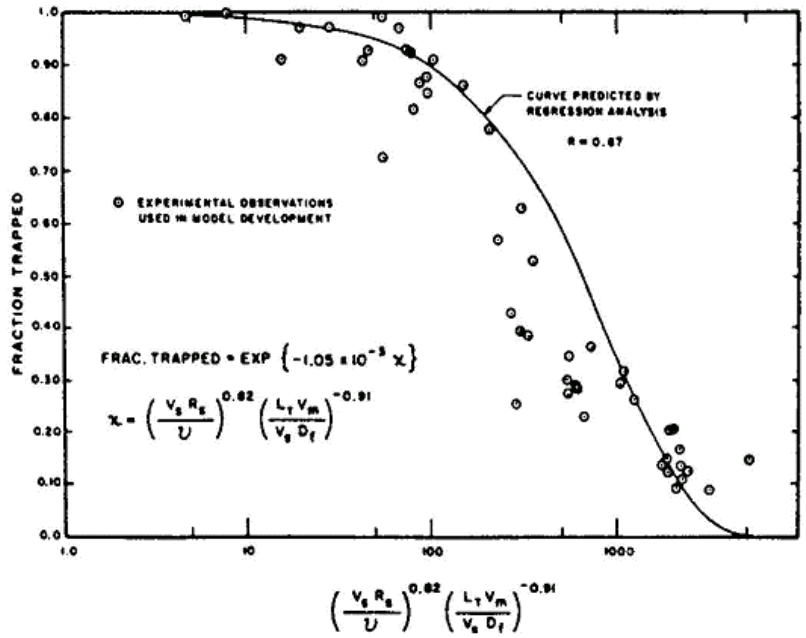
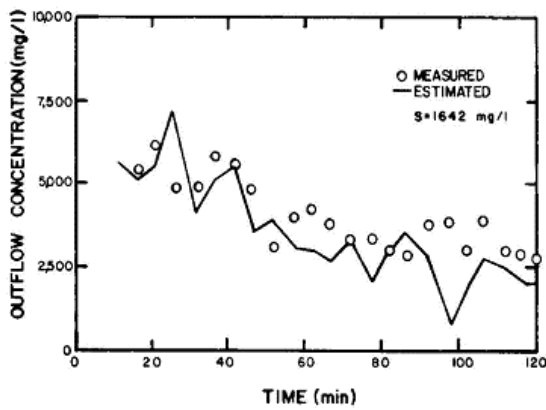

Figure 5-11 Plot of Data for Kentucky Grassfill Model (Tollner et al., 1982 from ASCE and Hayes et al., 1984 from Transactions ASAE) (Reprinted with permission from ASCE and ASAE)

Simplifying and defining total trapping efficiency, TE_i as the trapping due to settling and infiltration:

$$TE_i = \frac{M_i}{Y_{T,i}} = T_{r,i} \left[1 + \frac{i_r}{V_{s,i}} \right] \leq 1.0 \quad (5-27)$$

It is important to also keep track of mass of clay fraction trapped. By using the fraction of a given particle class that is clay, calculated from relationships in Table 4-8, the mass of clay trapped and discharged can also be calculated. Mass of clay trapped and discharged are used to determine trapping and discharge of pollutants (e.g., nutrients).

Trapping of Sediment in Grass Swales

Trapping of sediment in grass swales is done the same as for VFS, except the characteristic dimension in equation 5-22 should be changed to the traditional hydraulic radius, R , defined by equation 5-17.

The accuracy of the Kentucky Grassfil model was evaluated carefully by Hayes et al. (1984) and by Dillaha et al. (1989). The routines are included in SEDIMOT II (Wilson et al., 1983) and SEDIMOT III (Barfield et al., 1993).

Trapping of Sediment by Particle Size Class for VFS and Grass Swales

The sum of the fraction trapped by settling and infiltration for each particle class, TE_i , previously defined by equation 5-27 is used to calculate the sediment discharged for each size class, $M_{D,i}$:

$$M_{D,i} = Y_T F_i (1 - TE_i) \quad (5-28)$$

where: $M_{D,i}$ = mass of sediment discharged in kg (lb) for particle size classification i ,
 Y_T = the total sediment yield in a storm, in kg (lb),
 F_i = the fraction of sediment in a given particle size classification i , and
 TE_i = the trapping efficiency for particle size i .

The total sediment discharged, M_D , in kg (lb) for the five class sizes (as defined in Section 4) is:

$$M_D = \sum_{i=1}^5 M_{D,i} = Y_T \sum_{i=1}^5 F_i (1 - TE_i) \quad (5-29)$$

Trapping efficiency, TE , for all particles combined is given by:

$$TE = \sum_{i=1}^5 F_i TE_i \quad (5-30)$$

Size Distribution Calculations for Discharged Sediment

Mass of TSS in any effluent size class, $M_{D,i}$, in kg (lb), is given by equation 5-28. The fraction of discharged yield in a given size range, $F_{YD,i}$, is thus:

$$F_{YD,i} = \frac{M_{D,i}}{Y_T} = F_i (1 - TE_i) \quad (5-31a)$$

The fraction of discharged sediment in a given size range, $F_{MD,i}$, is thus:

$$F_{MD,i} = \frac{M_{D,i}}{M_D} = \frac{F_i(1-TE_i)}{\sum_{i=1}^5 F_i(1-TE_i)} \quad (5-31b)$$

Clay Sized Particles and Active Clay Calculations

Mass of trapped and discharged clay sized particles (**CP**), $M_{CP,T}$ and $M_{CP,D}$, respectively are given by:

$$M_{CP,T} = Y_T \sum_{i=1}^5 F_i C F_i T E_i \quad (5-32)$$

and

$$M_{CP,D} = Y_T \sum_{i=1}^5 F_i C F_i (1-TE_i) \quad (5-33)$$

where: CF_i = the fraction of clay sized particles.

In the right hand side of the equation, all parameters are for inflow to the VFS or bioswale. Mass of active clay discharged, $M_{AC,D}$, in kg (lb) is given by:

$$M_{AC,D} = M_{CP,D} - \sum_{k=1}^m M_{SD,k} \quad (5-34)$$

where $M_{SD,k}$ is the mass of settleable particulates in nutrient or pollutant **k** that are discharged and **m** is the total number of pollutants and nutrients that have settleable particulates. The subscript, **S**, stands for settleable.

Active clay is clay capable of partitioning pollutants and is the clay particles for which the isotherm relationships are developed. The trapping efficiency for active clay, TE_{AC} , is given by:

$$TE_{AC} = \frac{M_{CP,T} - \sum_{k=1}^m M_{ST,k}}{Y_T \sum_{i=1}^5 F_i C F_i - \sum_{k=1}^m M_{S,infl,k}} \quad (5-35)$$

where: $M_{ST,k}$ = mass of settleable particulates in the nutrients and pollutants, **k**, trapped, subscript **T**, in kg (lb), and, $M_{S,infl,k}$ = mass of settleable particulates in nutrients and pollutants, **k**, in kg (lb) in inflow, subscript **infl**.

Chemical Pollutants Routing

Chemicals in the dissolved state are assumed to be conservative. For VFS and bioswales, and the majority of chemicals, this is a reasonable assumption. Therefore, the trapping that occurs results from settling of the settleable component of the chemicals, referred to as particulate chemicals and trapping of chemicals sorbed on active clay particles.

Settleable Fraction

Trapping of chemicals in VFS can occur as a result of settling of particulate or settleable fraction of the chemicals washed or eroded from the watershed. These chemicals, as indicated earlier, can be assumed to be part of clay sized fraction and trapping is assumed to be calculated the same as for clay particles.

If $F_{P,k,i}$ is the fraction of clay sized particles in size class i that are particulate chemical, k , i.e., settleable particles, then total mass of particulates, $M_{S,k}$, in VFS inflow for a given pollutant, k , is given by:

$$M_{S,k} = Y_T \sum_{i=1}^5 F_i C F_i F_{P,k,i} \quad (5-36)$$

Routinely, one would expect $F_{P,k,i}$ to be a known quantity based on empirical data. However, there may be times when $F_{P,k,i}$ is not known but there is EMC pollutant data available for the fraction class. Defining the fraction of the EMC for a given pollutant that is particulates as $F_{S,k}$ and $F_{P,k,i}$ is assumed to be constant across all particle classes (that is the clay component of the aggregates as well as the clay sized fraction), then $F_{P,k,i}$ can be calculated by:

$$F_{P,k,i} = \frac{\gamma F_{S,k} EMC_k QA Const_4}{Y_T \sum_{i=1}^5 F_i C F_i} \quad (5-37)$$

where: EMC_k = the EMC of any pollutant, k .

Using equations 5-36 and 5-37 along with trapping efficiency defined by equation 5-20 or 5-27, the mass of a given settleable pollutant trapped and discharged, $M_{ST,k}$ and $M_{SD,k}$ are given by:

$$M_{ST,k} = Y_T \sum_{i=1}^5 F_i C F_i F_{P,k,i} TE_i \quad (5-38)$$

and

$$M_{SD,k} = Y_T \sum_{i=1}^5 F_i C F_i F_{P,k,i} (1 - TE_i) \quad (5-39)$$

Dissolved and Absorbed Fraction

The mass of a pollutant absorbed on the active clay fraction incoming to the VFS or bioswale is defined by equation 4.38. The amount of the pollutant mass trapped as being sorbed on the active clay, M_{DAT} , in kg (lb), can be calculated by multiplying the concentration in the solid phase from equation 4.37, C_S , by the yield of clay, Y_{AC} , by the trapping efficiency for active clay fraction using equation 5-35, TE_{AC} , or:

$$M_{DAT} = C_S Y_{AC} TE_{AC} \times 10^{-6} \quad (5-40)$$

and the amount of pollutant mass discharged, M_{DAD} , can be calculated by:

$$M_{DAD} = C_S Y_{AC} (1 - TE_{AC}) \times 10^{-6} \quad (5-41)$$

Nutrient Trapping in Grass Swales

Trapping of nutrients occurs as a result of settling particulate nutrients to the channel bed and by settling of clay particles to the bed with sorbed nutrients on the exchange phase. Infiltration also takes dissolved nutrients into the soil matrix.

Example Problems on VFS and Bioswales

Example Problem 5.1: Hydraulic Calculations for VFS

Assume that the discharge from a 0.75 in. rainfall on a 3 acre parking lot in Charleston, SC, before entering a storm drain, travels over a vegetative filter strip that is 30 ft long (parallel to the flow path) and located on a slope of 5%. The filter strip is vegetated with Bermuda grass that is mowed on a weekly basis. The filter strip is 200 ft wide perpendicular to the flow path and located along the downslope side of the parking lot. The following storm information has been determined for the parking lot:

Runoff volume, Q (in.) = 0.653, and
Peak flow rate, q_p (cfs) = 2.023.

Determine the peak outflow rate (q_{po}), outflow volume (Q_o), net infiltration volume ($V_{inf-prec}$), average velocity of flow (q_a) and the average depth of flow (d_f). Also, determine if the vegetation will stand erect or lay over during a storm. Assume that the infiltration rate (i_r) has been measured and found to be 0.25 in/hr for the area of the filter as a result of compaction during construction.

Solution:

1. Time Base of the Inflow Hydrograph.

The infiltration opportunity time is the time base of the inflow hydrograph. From equation 5-4:

$$t_b = \frac{2QA}{q_p} \text{Const}_2 = \frac{2 \times 0.653 \times 3}{2.023} 1.008 = 1.952 \text{ hr}$$

2. Infiltration Volume.

The average rainfall rate during the storm would be the precipitation divided by the duration as approximated by the time base, or:

$$\frac{dP}{dt} = \frac{P}{t_b} = \frac{0.75}{1.953} = 0.384 \text{ in / hr}$$

Using equation 5-5, the potential infiltration volume, in watershed inches, for calculating infiltration of chemicals and sediment is:

$$V_i = i_r t_b = 0.25 \times 1.952 = 0.488 \text{ in.}$$

Using equation 5-6, the net of infiltration minus rainfall, used to calculate peak outflow rate and outflow volume from the filter is:

$$V_{inf-prec} = \left(i_r - \frac{dP}{dt} \right) t_b = (0.25 - 0.384) \times 1.952 = -0.262 \text{ in.}$$

The negative number means that the rainfall rate was greater than the infiltration rate. The outflow volume must be calculated on true volume basis rather than watershed basis. The area of the filter in acres, A_f is:

$$A_f = 200 \times 30 / 43,560 = 0.1374$$

Hence, the outflow volume is also calculated on a true volume basis using equation 5-7:

$$Q_o = \frac{QA - V_{inf-prec} A_f}{A + A_f} = \frac{(0.6531 \times 3) - (-0.262 \times 0.1374)}{3 + 0.137441} = 0.6358 \text{ in.}$$

3. Peak Outflow Rate.

The outflow rate, from equation 5-8 must use consistent units. The runoff volume from the parking lot, which must again be calculated on a true volume basis, is:

$$q_{po} = q_p \frac{Q_o}{Q} = 2.023 \frac{0.6358(3 + 0.137441)}{(0.6531 \times 3)} = 2.060 \text{ ft}^3 / \text{s}$$

The average flow rate through the filter is calculated by equation 5-9:

$$q_a = \frac{q_p + q_{po}}{2} = \frac{2.023 + 2.060}{2} = 2.042 \text{ ft}^3 / \text{s}$$

The discharge per unit width, from equation 5-10, is:

$$q_w = q_a / W = 2.042 / 200 = 0.0102$$

4. Hydraulic Calculations.

From Table 5-3, the calibrated Manning's n for Bermuda grass is 0.074, the average grass spacing is 0.54 in and the stiffness of the vegetation is 9.0 N/m². The discharge is the product of area times velocity using equation 5-12:

$$q_w = \frac{1.49}{n} d_f \left[\frac{d_f S_s}{S_s + 2d_f} \right]^{2/3} S^{1/2}$$

$$0.0102 = \frac{1.49}{0.074} d_f \left[\frac{d_f (0.54/12)}{(0.54/12) + 2d_f} \right]^{2/3} 0.05^{1/2}$$

The above equation is nonlinear, and must be solved by trial and error for a value of d_f . The solution is:

$$d_f = 0.0386 \text{ ft}$$

5. Checking whether the Vegetation Will Remain Erect.

The stiffness for Bermuda grass, **MEI**, is 9.0 N/m from Table 5-3, assuming that the grass is unmowed. Using equations 5-14 and 5-15 values for U_{c1}^* and U_{c2}^* are calculated as:

$$U_{c1}^* = \text{Const}_7 \left[0.091 + 20.76 (\text{MEI})^2 \right] = \left[0.091 + 20.76 (9.0)^2 \right] = 1682 \text{ ft / s}$$

$$U_{c2}^* = \text{Const}_7 \left[0.754 (\text{MEI})^{0.108} \right] = \left[0.754 (9)^{0.108} \right] = 0.952 \text{ ft / s}$$

From equation 5-13, the actual shear velocity is:

$$U^* = \sqrt{gd_f S} = \sqrt{32.2 \times 0.0386 \times 0.05} = 0.2493 \text{ ft/s}$$

Since the actual shear velocity is less than either of the two critical values, the grass should remain erect.

Example Problem 5.2: Calculating Sediment Trapping in a Vegetative Filter Strip

Determine the effluent sediment load and fraction of clay sized particles for the VFS in Example Problem 5.1, both for the single storm used in the problem and for an average storm during a year. The sediment load and concentrations along with particle size entering the filter strip are given in Table 5-6.

Table 5-6 Sediment Load Concentration and Particle Size

Sediment Loading		lb	mg/l	mg/g
TSS		51.93	117	-
Clay Sized Particles (CP)		13.50	30.42	-
Particle Size Information	Diameter (mm)	Settling Velocity V_s (ft/s)	Fraction in Class F_i	Fraction CP in Class CF_i
Clay F_{cl}	0.002	1.12×10^{-5}	0.06	1.000
Silt F_{si}	0.01	2.81×10^{-4}	0.16	0.000
Sand F_{sa}	0.2	6.36×10^{-2}	0.78	0.000

Solution:

1. Trapping Efficiency and Effluent Yield.

Reynolds' number and the fall number are needed in calculating the trapping efficiency. From the example problem 5.1 above, the spacing hydraulic radius, R_s , is explicitly calculated by equation 5-11:

$$R_s = \frac{d_f S_s}{S_s + 2d_f} = \frac{0.0386 (0.54/12)}{(0.54/12) + (2 \times 0.0386)} = 0.0142 \text{ ft}$$

The average velocity, from Manning's equation (equation 5-12, adjusted) as applied to VFS, calculates the average velocity, or:

$$V = \frac{1.486}{n} R_s^{2/3} S^{1/2} = \frac{1.486}{0.074} 0.014^{2/3} 0.05^{1/2} = 0.2642 \text{ ft / sec}$$

From velocity, the Reynolds' number can be calculated from equation 5-22 using a kinematic viscosity of 10^{-5} ft²/s:

$$Re = \frac{VR_s}{\nu} = \frac{0.2642 \times 0.0142}{10^{-5}} = 376$$

The fall number is given by equation 5-23 as:

$$N_f = \frac{L_r/V}{d_f/V_s} = \frac{30/0.2642}{0.038/V_s} = 2942 V_s$$

The settling and total trapping efficiency can be calculated for each particle class. Using equation 5-21 along with values from Example Problem 5.1, the trapping efficiency due to settling alone is:

$$\begin{aligned} T_{r,1} &= \exp\left[-0.00105 Re^{0.82} N_{f,i}^{-0.91}\right] = \exp\left[-0.00105 \times 376^{0.82} (2942 V_{s,i})^{-0.91}\right] \\ &= \exp\left[-9.461 \times 10^{-5} \times V_{s,i}^{-0.91}\right] \end{aligned}$$

Using equation 5-27, the total trapping efficiency due to settling and infiltration is:

$$TE_i = T_{r,i} \left[1 + \frac{i_r}{V_{s,i}}\right] = \exp\left[-9.462 \times 10^{-5} \times V_{s,i}^{-0.91}\right] \left[1 + \frac{0.25/(12 \times 3600)}{V_{s,i}}\right] \leq 1.0$$

Using equations 5-28, the mass of effluent for each size class, $M_{D,i}$, is calculated, as shown in the table 5-7. In addition, the mass of clay sized particles in the effluent, $M_{CP,D}$, as calculated by equation 5-33 is shown for each particle class along with the totals in Table 5-7.

Table 5-7 Mass of Effluent for Each Class Size

Sediment Loading						
Y_T Suspended Solids (TSS) = 51.93 lb						
Clay Sized Particles (CP) = 13.50 lb						
Particle Size Information	Diameter (mm)	Settling Velocity ft/s	Fraction in Class F_i	Fraction CP in Class CF_i	Trapping Efficiency TE_i	Mass of Sediment in Effluent for the class, $M_{D,i}$ lb
Clay	0.002	1.12×10^{-5}	0.06	1.000	0.048	2.89
Silt	0.01	2.81×10^{-4}	0.16	0.000	0.851	1.09
Sand	0.2	6.36×10^{-2}	0.78	0.000	0.999	0.04
Totals			1.00			4.02

The total trapping efficiency is given by equation 5-30 as:

$$TE = \sum_{i=1}^5 F_i TE_i = 0.06(0.048) + 0.16(0.851) + 0.78(0.999) = 0.923$$

From the previous results, the effluent sediment load is given by equations 5-29:

$$M_D = \sum_{i=1}^5 M_{D,i} = Y_T \sum_{i=1}^5 F_i (1 - TE_i) = Y_T (1 - TE) = 51.93(1 - 0.923) = 4.02 \text{ lb}$$

The mass of clay sized particles discharged is given by equation 5-33 as:

$$M_{CP,D} = Y_T \sum_{i=1}^5 F_i CF_i (1 - TE_i) = 2.89 \text{ lb}$$

2. Size Distribution and Fraction of Clay for the Effluent

The fraction of effluent in a given size range can be calculated by equation 5-28. Equation 5-31b allows for the calculation of the discharged sediment in any given size range:

$$F_{MD,i} = \frac{F_i (1 - TE_i)}{\sum_{i=1}^5 F_i (1 - TE_i)} = \frac{0.06(1 - 0.092)}{0.06(1 - 0.092) + 0.16(1 - 0.879) + 0.78(1 - 0.999)} = 0.73$$

Other values are tabulated and totaled in Table 5-8. These results are shown in the graph, Figure 5-12, illustrating how the fraction of a given size class changes in the flow through the filter.

Table 5-8 Tabulated Results of Effect of Fraction Class

Particle Size Class	Fraction in Class, F_i	Trapping Efficiency, TE_i	Fraction Yield in Effluent, $F_{YD,i}$	Fraction Sediment in Effluent, $F_{MD,i}$
Clay	0.06	0.048	0.0555	0.72
Silt	0.16	0.851	0.0210	0.27
Sand	0.78	0.999	0.0008	0.01
Small Aggregate	0	0	0	0
Large Aggregate	0	0	0	0
Totals	1	0.923	0.0775	1

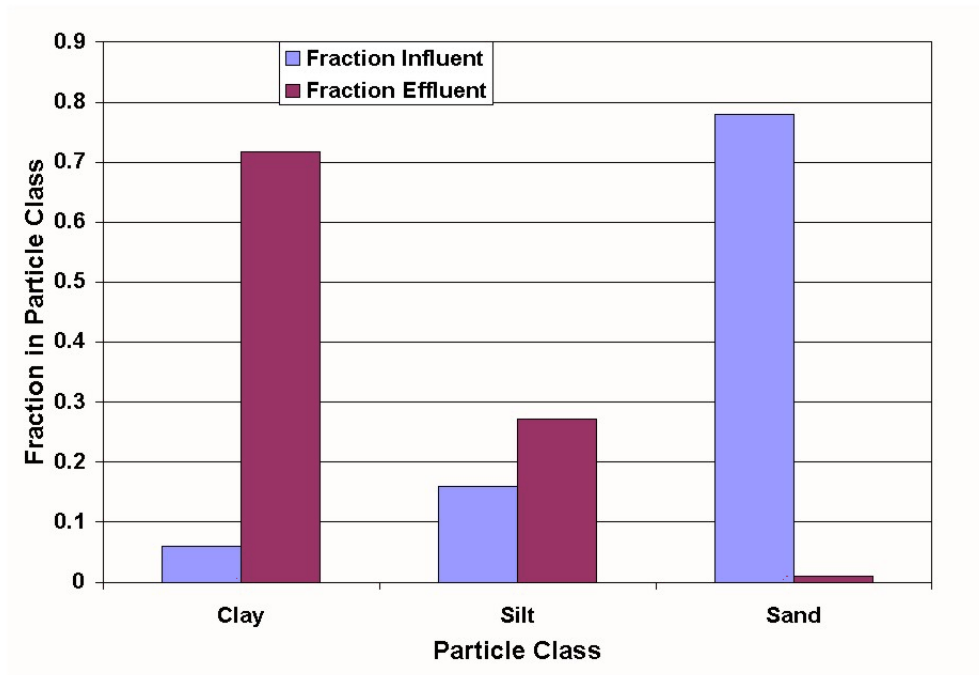

Figure 5-12 Particle Size Class Change in Flow through Filter

Example Problem 5.3 Analysis of Vegetated Filter Strip Using IDEAL

A 2.57 acre strip mall is being for construction in Beaufort, SC as shown in Figure 5-13. Post construction runoff from the strip mall is proposed to travel over a Bermuda grass VFS BMP that is 300 ft wide perpendicular to the flow direction and 25 ft along the flow direction with a slope of 1.5%. Grass will typically be mowed to an average height of 2 in. The average spacing for Bermuda grass is 0.054 in. and Manning's n is 0.074. The soil has an average infiltration rate of 0.3 in/hr and the time of concentration has been estimated to be 6 minutes. Isotherms have been run for the soil for nitrogen and phosphorus and values for K and $C_{S,max}$ determined as shown in Table 5-9. The fraction of nutrients that are particulates, excluding those sorbed on the clay particles, is also given in Table 5-9. Calculate the runoff, sediment and nutrients flowing into and out of the VFS in an average storm, annual storm and total average annual runoff using the IDEAL model.

Table 5-9 Example Isotherm Values for Coastal South Carolina

Chemical	Particulate Fraction	K (: g/l)	$C_{S,max}$ ($\mu\text{g/g}$)
Nitrogen	0.25	32	1050
Phosphorus	0.20	4100	1660

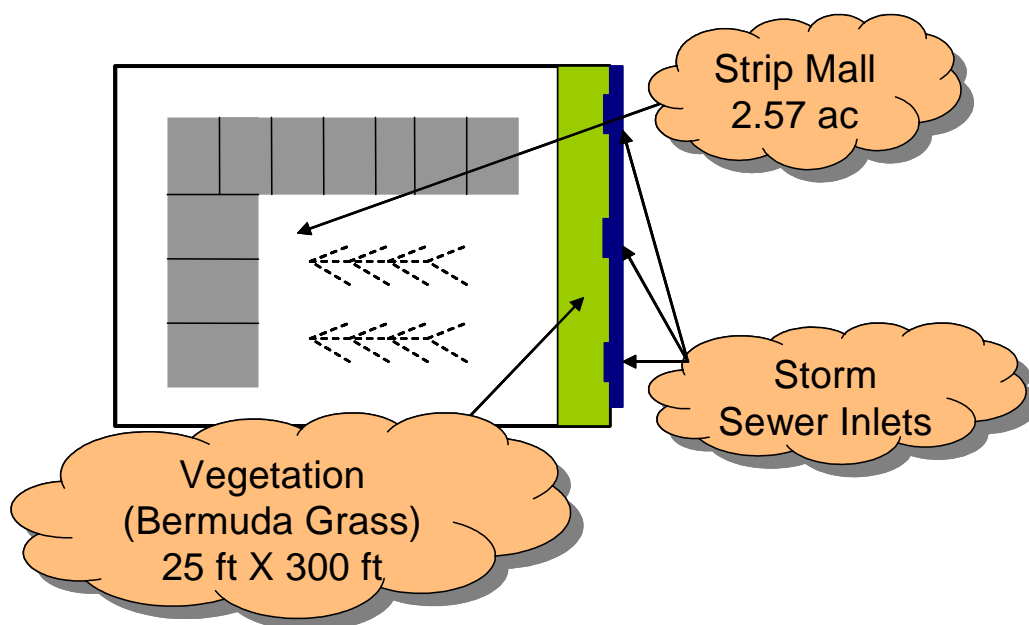

Figure 5-13 Strip Mall Development for Example Problem 5.3

Solution:

From Table 4-7 and 4-11, the EMC values for commercial sites are 116 mg/L for TSS, 0.23 mg/L for phosphorus and 1.90 mg/l for nitrogen. Representative diameters and fractions of primary particles for TSS washed from the impervious areas are given in Table 4-9. As indicated in the discussion of Table 4-9, it is assumed that all sediment in runoff from impervious area are primary particles. Some of the rainfall statistics for Beaufort, SC, are already provided in Table 4-13. Additional rainfall statistics are provided in Table 5-10.

Table 5-10 Rainfall Probability Based on Cumulative Storm Depth for Beaufort, SC

Bin No.	1	2	3	4	5	6	7	8	9	10	11	12
Rain (in.)	0.25	0.75	1.5	2.5	3.5	4.5	5.5	6.5	7.5	8.5	9.5	10.5
Probability	0.789 2	0.117 6	0.069 7	0.014 8	0.005 3	0.002 3	0.000 5	0.000 4	0.001	0	0.000 1	0.0001

Information for the input worksheet for the IDEAL model are shown in screen captures from the IDEAL model spreadsheet version in Figures 5-14 and 5-15. Screen captures of the output values are shown in Figures 5-16 through 5-18.

Example Problem to Illustrate Use of Model		
<i>Cells with shading and blue font are for user input.</i>		
Item	Values	
Area and Land Use		
Total Area (ac)	2.57	
% Pervious Area (All Three Percentages Must Add to 100)	0	
% Impervious Area Not Connected to Drainage Channels (%)	0	
% Impervious Area Connected to Drainage Channels (%)	100	
Hydrologic Information		
Precipitation Table used (1 if User Defined (See "User Defined Storm Data" for input) or 2 for Example Data Using GSP Airport)		
	1	
Land Use (By listed Categories)		
Impervious Area Con. To Drainage Ch	Strip Mall	
Curve Numbers CN for AMC II		
Impervious Area Connected to Drainage Channel	98	
Combined CN (AMC II) for Pervious Areas and Impervious Area Not Connected	0.0	
Area Weighted CN (AMC II) for all Watersheds	98.0	
Time of Concentrations		
Impervious Areas Connected to Drainage Channel (hr)	0.1	
Event Mean Concentrations		
EMC		
Impervious Areas Connected to Drains		Fraction Settleable
TSS (mg/l)	116	
Nitrogen (mg/l)	1.9	0.25
Phosphorus (mg/l)	0.23	0.20
Bacterial Indicators (organisms/100ml) <i>Fecal Coliform</i>	15000	
Pervious Areas and Impervious Areas Not Connected to Drains		
Nitrogen (mg/l)	1.88	0.25
Phosphorus (mg/l)	0.4	0.20
Bacterial Indicators (organisms/100ml)	15000	
Isotherm Values for Chemicals and Bacteria		
K		
Nitrogen - values should be based on tests of local soils	32	CSmax
Phosphorous - values should be based on local soils	4100	1660
Values of K and CS _{max} should be based on testing of local soils and be conservative		

Figure 5-14 IDEAL Input for Area, Land Use, Hydrologic Information, EMC and Isotherm Data for Example Problem 5.3

7		Example Problem to Illustrate Use of Model	
11		<i>Cells with shading and blue font are for user input.</i>	
78		Vegetated Filter Strip Information	
81	Connected Impervious Area		
82	Filter Prescribed (yes=1, no=0)	1	
83	Width (Perpendicular to Flow) (ft)	300	
84	Length (Along Flow Path) (ft)	25	
85	Slope (ft/ft)	0.015	
86	Vegetative Type (Grass Only)	Bermuda	
87	Equivalent Spacing of Vegetative (grass) elements in inches (Based on Type Grass)	0.54	
88	Height of Grass (in)	2	
89	Manning's n	0.074	
90	Infiltration Rate (iph)	0.3	

Figure 5-15 IDEAL Input for Vegetative Filter Strip Information for Example Problem 5.3

1					IDEAL MODEL OUTPUT				
3					Example Problem to Illustrate Use of Model				
38		Runoff and Peak Discharges		Avg Storm		Annual Storm		Total Annual	
39									
40		Average Annual Single Storm							
41	Rainfall (in)			0.46		4.00		46.41	
42		Flow From Watershed to BMP's (If BMPs are Specified)							
43	Q(ac-ft)			0.05		0.76		5.24	
44	Q(in)			0.24		3.57		24.47	
45	q _p (cfs)			0.98		14.48			
46		Fraction of Rainfall That Becomes Runoff		0.53		0.89		0.53	
47		Volume of Rainfall on the Filters (if specified) (ac-ft)		0.01		0.06		0.67	
48		Volume of Water Infiltrated in VFS (if specified) (ac-ft)		0.01		0.01		0.61	
49		Flow From VFS Into Pond (If VFS is Specified)							
50	Q(ac-ft)			0.05		0.82		5.29	
51	Q(in)			0.25		3.81		24.71	
52	q _p (cfs)			1.00		15.46			

Figure 5-16 Runoff and Peak Discharge into and from Vegetated Filter Strip for Example 5.3

1	IDEAL MODEL OUTPUT			
3	Example Problem to Illustrate Use of Model			
59	Sediment Loading and Trapping	Avg Storm	Annual Storm	Total Annual
60				
61	<i>Watershed Yield</i>	Avg Storm	Annual Storm	Total Annual
62	Total TSS Yield From Watershed Into VFS or Drain (lbs)	16.52	1652.31	1652.31
63	Average Concentration (mg/l)	116.00	116.00	116.00
64	Clay Sized Particles (lbs)	4.30	62.67	429.60
65	Settleable Nitrogen (lbs)	0.07	0.99	6.77
66	Settleable Phosphorus (lbs)	0.01	0.10	0.66
67	Active Fraction (clay) (lbs)	4.22	61.59	422.18
68				
69	<i>Trapping in Vegetative Filter Strips (If Specified)</i>			
72	Material Trapped			
73	TSS (lbs)	10.3959	0.0000	1039.59
74	Clay Sized Particles (lbs)	1.2596	0.0000	125.9617
75	Settleable Nitrogen (lbs)	0.0198	0.0000	1.9838
76	Settleable Phosphorus (lbs)	0.0019	0.0000	0.1921
77	Active Fraction (clay) (lbs)	1.2379	0.0000	123.79
78	Trapping Efficiency (TSS)	0.6292	0.0000	0.6292
79	Material Discharged			
80	TSS (lbs)	6.1273	241.0483	612.73
81	Conc Total Solids (mg/l)	42.6025	108.6264	42.60
82	Clay Sized Particles (lbs)	3.0364	62.6726	303.6399
83	Settleable Nitrogen (lbs)	0.0478	0.9871	4.7821
84	Settleable Phosphorus (lbs)	0.0046	0.0956	0.4631
85	Active Fraction (clay) (lbs)	2.9839	61.5899	298.39

Figure 5-17 Sediment Loading into and Discharge from Vegetated Filter Strip for Example 5.3

1	IDEAL MODEL OUTPUT			
3	Example Problem to Illustrate Use of Model			
121	Pollutant Loading and Trapping	Avg Storm	Annual Storm	Total Annual
126	<i>Nitrogen</i>	Avg Storm	Annual Storm	Total Annual
127	From Watershed (lbs)	0.2706	3.9482	27.06
128	From Watershed (mg/l)	1.9000	1.9000	1.90
129	From Filter (if specified) (lbs)	0.2508	3.9482	25.08
130	From Filter (if specified) (mg/l)	1.7604	1.7790	1.74
133	Fraction Trapped VFS (if specified)	0.0735	0.0000	0.07
136	<i>Phosphorus</i>			
137	From Watershed (lbs)	0.0328	0.4779	3.28
138	From Watershed (mg/l)	0.2300	0.2300	0.23
139	From Filter (if specified) (lbs)	0.0302	0.4779	3.02
140	From Filter (if specified) (mg/l)	0.2121	0.2154	0.21
143	Fraction Trapped VFS (if specified)	0.0778	0.0000	0.08

Figure 5-18 Pollutant Loading into and Discharge from Vegetated Filter Strip for Example 5.3

The spreadsheet version of IDEAL displays output in three columns: average storm, return period storm (here the annual storm) and total annual. A working definition of each of the outputs are:

Average storm - given that it rains, the value displayed for the variable would be what is expected in an average storm. Note that this is not a return period storm.

Return period storm - given that a return period storm occurs, the value displayed for the variable would be what is expected in that storm, averaged over all seasons and AMCs.

Total annual - the value displayed is the expected total value summed over all storms in a year. In the case of concentrations and trapping efficiencies, this value would be the average over all storms in a year. In the particular case shown, the average number of storms for Beaufort, SC was 100, so the annual value for loading is simply 100 times the average storm value. This would not typically be the case.

For this simulation, the average runoff (from Figure 5-16) from the strip mall is expected to be 0.25 in. from an average rainfall of 0.46 in. and the peak discharge is 1.00 ft³/s. Flow from the VFS is changed little from the inflow, as the average volume of rainfall on the filter is approximately equal to that infiltrating.

TSS yields (from Figure 5-17) are quite low, averaging 16.52 lb from the strip mall with only approximately 1/4th of that, 4.22 lb, in clay sized particles. Due to the coarse particle sizes, the VFS is expected to trap 63% of the sediment load averaged over all storms, reducing the TSS concentration from 117 mg/l to 43 mg/l. Nitrogen and phosphorus loads (from Figure 5-18) averaged over all storms are small and are not significantly reduced. Trapping efficiencies are not calculated for the model output, but are 7 and 8% respectively for both nitrogen and, averaged over all storms.

For the annual storm, the trapping of nitrogen and phosphorus, as well as sediment, is zero (although a very small fraction of sediment may have been trapped). Flow submerges the vegetation. The decreased concentration is not calculated as a result of trapping, but as a result of the volume of runoff increasing through the filter as a result of rain on the VFS. For large storms, the rainfall volume falling on the filter will greatly exceed the infiltration rate.

Trapping of nutrients is a complex function of the fraction of clay in sediment, the fraction of clay trapped and partitioning of nutrients to clay. In general trapping of sediment and nutrients increases with flow length. Further sensitivity analysis could be done, but is beyond the scope of this example. Trapping can be a function of slope when VFS is used in areas such as construction sites where sediment loads are high. Sediment transport capacity is decreased in the filter resulting in deposition when the sediment load exceeds transport capacity, as is often the case. Since transport capacity is greatly impacted by slope, trapping can be a strong function of slope in this case. IDEAL was developed for post construction watersheds, not construction watersheds and does not include this computational capability. Transport capacity is included in other models, e.g. SEDIMOT III (Barfield et al., 1996).

Other System Components

Level Spreader

A level spreader should be provided at the upper edge of a VFS when the width of the contributing drainage area is greater than that of the filter. Runoff may be directed to the level spreader as sheet flow or concentrated flow. However, the design must ensure that runoff fills the spreader evenly and flows over the level lip as uniformly as possible. The level spreader should extend across the width of the filter, leaving only 10 ft open on each end.

There are many alternative spreader devices, with the main consideration being that the overland flow spreader be distributed equally across the strip. Level spreader options include porous pavement strips, stabilized turf strips, slotted curbing, rock-filled trench, concrete sills, or plastic-lined trench that acts as a small detention pond (Yu and Kaighn, 1992). The outflow and filter side lip of the spreader should have a zero slope to ensure even runoff distribution (Yu and Kaighn, 1992). Figure 5-19 provides examples of level spreaders.

Pervious Berm

To force ponding in a VFS, a pervious berm may be installed. It should be constructed using a moderately permeable soil such as ASTM ML, SM, or SC. Soils meeting USDA sandy loam or loamy sand texture, with a minimum of 10 to 25% clay, may also be used. Additional loam should be used on the berm ($\pm 25\%$) to help support vegetation. An armored overflow should be provided to allow larger storms to pass without overtopping the berm. Maximum ponding depth behind a pervious berm is 1 ft.

CROSS SECTION

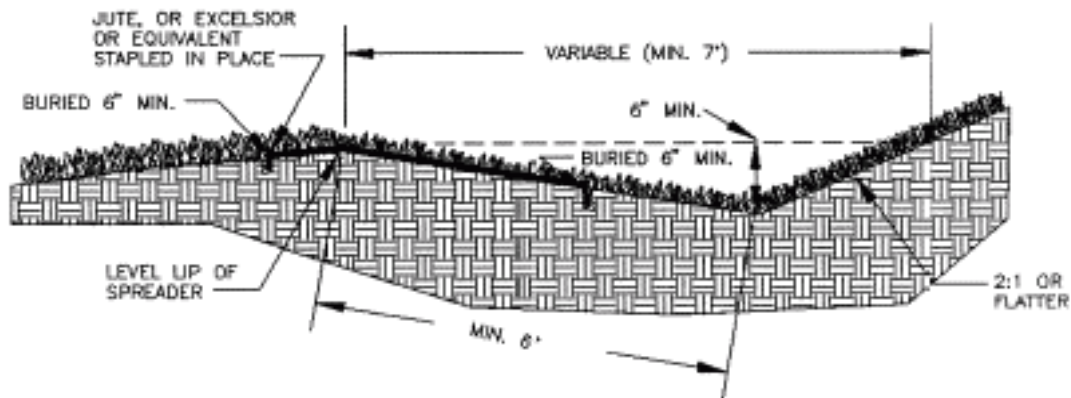

LEVEL SPREADER WITH VEGETATED LIP

CROSS SECTION

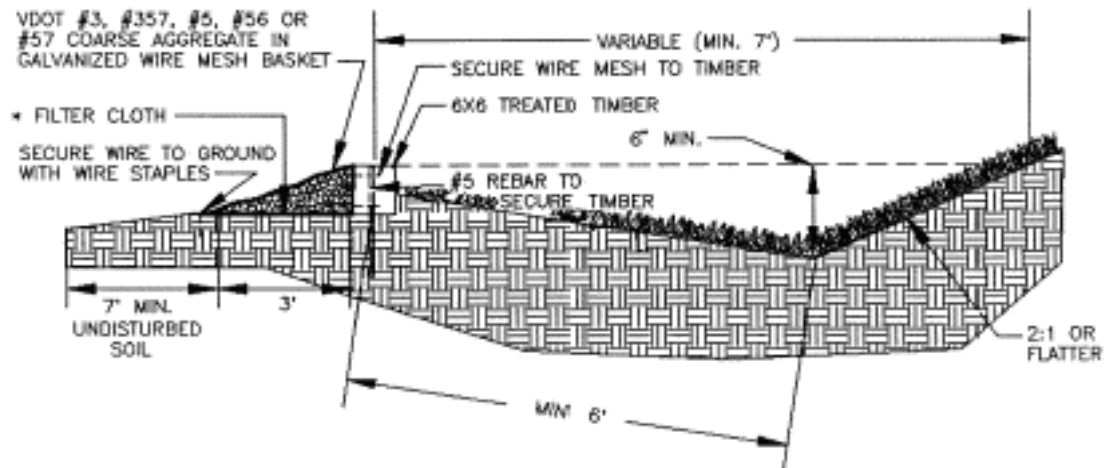

LEVEL SPREADER WITH RIGID LIP

* MIN. PHYSICAL REQUIREMENTS OF FILTER CLOTH NOTED IN STD. & SPEC. 3.19, RIPRAP

Figure 5-19 Level Spreader (Virginia Erosion and Sediment Control Handbook, Virginia Department of Conservation and Recreation, 3rd edition, 1992)

Vegetation

A filter strip should be densely vegetated with a mix of erosion resistant plant species that effectively bind the soil. Certain plant types are more suitable than others for urban stormwater control. The selection of plants should be based on their compatibility with climate conditions, soils and topography, and their ability to tolerate urban stresses from pollutants, variable soil moisture conditions and ponding fluctuations.

A filter strip should have at least two of the following vegetation types:

- deep-rooted grasses, ground covers, or vines
- deciduous and evergreen shrubs
- under- and over-story trees.

Native plant species should always be specified. This will facilitate establishment and long term survival. Non-native plants may require more care to adapt to local hydrology, climate, exposure, soil and other conditions. Also, some non-native plants may become invasive, ultimately choking out the native plant population. This is especially true for nonnative plants used for stabilization.

Newly constructed stormwater BMPs will be fully exposed for several years before the buffer vegetation becomes adequately established. Therefore, plants which require full shade, are susceptible to winter kill or are prone to wind damage should be avoided. Plant materials should conform to the American Standard for Nursery Stock, current issue, as published by the American Association of Nurserymen. The botanical (scientific) name of the plant species should be according to the landscape industry standard nomenclature. All plant material specified should be suited for USDA Plant Hardiness Zones.

Filter strips should be constructed of dense, soil-binding deep-rooted water-resistant plants. For grassed filter strips, dense turf is needed to promote sedimentation and entrapment, and to protect against erosion (Yu and Kaighn, 1992). Turf grass should be maintained to a blade height of 50 to 60 mm (2 to 4 in). Most engineered, sheet-flow systems are seeded with specific grasses. Common grasses established for filter strip systems are rye, Kentucky bluegrass, reed canary, fescue, wheatgrass (Horner, 1988) and Bermuda. Tall fescue and orchard grasses grow well on slopes and under low nutrient conditions. The grass species chosen should be appropriate for the climatic conditions and maintenance criteria for each project. See Tables 6-4 and B-2 in Appendix B 4 for details on appropriate grass types; designers should verify the grass types in the tables are suitable for their area by seeking local guidance.

Trees and woody vegetation have been shown to increase infiltration and improve performance of filter strips. Trees and shrubs provide many stormwater management benefits by intercepting some rainfall before it reaches the ground, and improving infiltration and retention through the presence of a spongy, organic layer of materials that accumulates underneath the plants (Schueler, 1987). As discussed previously in this section, wooded strips have shown significant increases in pollutant removal over grass strips. Maintenance for wooded strips is virtually non-existent, another argument for using trees and shrubs. However, there are drawbacks to using woody plants. Since the density of the vegetation is not as great as a turf grass cover, wooded filter strips need additional length to accommodate more vegetation. In addition, shrub and tree trunks can cause uneven distribution of sheet flow, and increase the possibility for development of gullies and channels. Consequently, wooded strips require flatter slopes than a typical grass cover strip to ensure that the presence of heavier plant stems will not facilitate channelization.

Filter strips managed to allow "natural succession" of vegetation from grasses to shrubs and trees provide excellent urban wildlife habitat. Judicious planting of selected native shrub and trees can be used to enhance the quality of food and cover for a variety of animal species (Schueler, 1987). To facilitate this approach, a landscaping plan should be included in the project specifications.

Construction Guidelines

Overall, widely accepted construction standards and specifications, such as those developed by the USDA Soil Conservation Service or the U.S. Army Corps of Engineers, should be followed where applicable to construct a VFS. The specifications should also satisfy all requirements of the local government.

Sequence of Construction

VFS construction should be coordinated with the overall project construction schedule. Rough grading of the filter strip should not be initiated until adequate erosion controls are in place.

Soil Preparation

Topsoil should be 8 in. thick, minimum. If grading is necessary, the topsoil should be removed and stockpiled. If the subsoil is either highly acidic or composed of heavy clays, ground dolomite limestone should be applied at an appropriate rate based on soil and slope conditions. Subsoil should be tilled to a depth of at least 3 in. to adequately mix in soil additives and to permit bonding of the topsoil to the subsoil. If the existing topsoil is inadequate to support a densely VFS, then suitable material should be imported. Proper specifications for imported topsoil should include the following:

- the USDA textural triangle classification
- requirements for organic matter content (not less than 1.5% by weight), pH (6 to 7.5) and soluble salt (not greater than 500 ppm)
- placement thickness and compaction.

Topsoil should be uniformly distributed and compacted, and should have a minimum compacted depth of 6 to 8 in. All seeding, fertilization and mulching should be per local guidance or as specified by a qualified agronomist.

Maintenance

Required maintenance depends on whether the natural vegetative succession is allowed to proceed (Schueler, 1987). For wooded filter strips, maintenance is minimal, and the gradual transformation from grass to meadow to second growth forest will enhance, rather than detract, from the performance of longer filter strips (Schueler, 1987). This process can be enhanced by intentional landscape plantings to facilitate vegetative succession. Maintenance tasks and costs are both sharply reduced for these "natural" filter strips. Corrective maintenance is still required around the edge of the strip. In arid and semiarid areas, VFS will need irrigation to maintain a dependable grass cover (ASCE/WEF, 1998).

Maintenance/Inspection Guidelines

VFSs require regular maintenance. Field studies indicate that these BMPs usually have short life spans because of lack of maintenance, improper location, and poor vegetative cover. The following maintenance and inspection guidelines are **NOT** all-inclusive. Specific facilities may require other measures not discussed here. It is the designer's responsibility to decide if additional measures would be required.

Filter strips should be inspected regularly for gully erosion, density of vegetation, damage from foot or vehicular traffic, and evidence of concentrated flows circumventing the strip. The level spreader should also be inspected to verify that it is functioning as intended. Inspections are critical during the first few years to ensure that the strip becomes adequately established.

Maintenance is especially important during this time and should include watering, fertilizing, re-seeding or planting as needed. Once a filter strip is well established and functioning properly, periodic maintenance, such as watering, fertilizing and spot repair, may still be necessary. However, fertilization efforts should be minimized. Natural selection allows certain species (usually native plants) to thrive while others decline. Excessive fertilization and watering to maintain

individual plantings may prove costly, especially in abnormally dry or hot seasons. Over seeding and replanting should be limited to those species which have exhibited the ability to thrive.

To increase the functional longevity of a VFS, the following practices are recommended:

- regular removal of accumulated sediment
- periodic reestablishment of vegetation in eroded areas or areas covered by accumulated sediment
- periodic weeding of invasive species or weeds
- periodic pruning of woody vegetation to stimulate growth.

Cost Considerations

The costs of establishing a filter strip are relatively low. Costs are negligible when an existing grass or meadow area is reserved at the site before development begins. Further savings are realized if the filter strip is used as an on-site erosion control practice during construction phase of development. Table 5-11 presents cost ranges for establishing vegetation under various seeding and planting techniques.

Maintenance costs for filter strips depend on length, vegetation type and frequency of mowing, but costs, relative to other BMPs, are low. Creation of VFSs does not require any permits, however it is important that the designer notes whether site conditions will permit the strip to effectively remove the pollutants of concern (Schueler et al., 1992).

Hydroseeding

Hydroseeding costs are influenced by the type of mulch and the mulch anchoring method used. Straw mulch used with asphalt tacking agents would place the cost in the higher end of the values listed. If the straw is anchored with a mulch anchoring tool instead of asphalt, the cost is reduced. Fiber mulches tend to be the least expensive.

Conventional Seeding

The type of mulch and method of anchoring influences the cost of conventional seeding in the same manner as for hydroseeding.

Sodding

Sodding costs are primarily dictated by the type of sod which is to be placed. Field sod is at the lower end of the range, blended bluegrass varieties are the most expensive, and certified Ky - 31 tall fescue falls in the middle. The price ranges include site preparation (exclusive of clearing and rough grading) liming, fertilization and one or two post installation waterings.

Fertilization of Buffer Areas

In some situations it is desirable to enhance the growth of existing vegetation along the perimeter of a project by fertilization. This improved stand of vegetation then acts to reduce runoff velocities and trap sediment which may not have been retained by other on site control practices. Caution must be exercised with this practice to avoid applying fertilizer during the hot-dry summer season and "burning" the vegetation.

Table 5-11 Comparative Costs for Vegetative Establishment (DC, 2002 and Schueler et al., 1992).

Establishment Method		Cost			Notes
Hydroseeding		< 2 acre	2 to 5 acre	> 5 acre	Permanent guaranteed establishment, includes seedbed preparation, mulch and fertilizer
Temporary	Range	\$1,050 - \$1,750	\$875 - \$1,550	\$725 - \$1,300	
	Average	\$1,350	\$1,150	\$1,025	
Permanent	Range	\$1,650 - \$2,200	\$1,350 - \$2,025	\$1,050 - \$1,750	
	Average	\$1,975	\$1,750	\$1,450	
Conventional Seeding		< 2 acre	2 to 5 acre	> 5 acre	
Temporary	Range	\$1,050 - \$1,750	\$875 - \$1,550	\$725 - \$1,300	
	Average	\$1,450	\$1,200	\$1,000	
Permanent	Range	\$1,450 - \$2,200	\$1,200 - \$1,975	\$1,050 - \$1,750	
	Average	\$1800	\$1,650	\$1450	
Sodding		acre			Price ranges include site preparation, liming, fertilization and one or two post installation waterings
Range		\$7,260 - \$19,360			
Average		\$10,890			
Fertilization of Buffer Areas		\$300 - \$400 / acre			
Forestry					
Deciduous		\$250 / hectare			Manual seedling planting, weed suppression.
Coniferous		\$500 / hectare			
Nursery Stock Planting		\$2500 - \$12350 /acre			Costs depend on species and size.

Straw Mulching

Although the various seeding methods previously described include the cost of mulching, in certain situations straw mulch is applied and anchored as a soil stabilizer without seed. This can occur when a recently graded site is to be left unattended after the normal seeding season has passed, or when extra soil protection is desired. The cost estimates are for applying straw mulch at a rate of 1.5- 2.0 tons per acre, and anchoring with a mulch anchoring tool. Anchoring the straw with asphalt adds approximately \$250- \$375/acre to the cost.

Flat Area Average: \$275/acre
 Sloped Area Average: \$400/acre.

Topsoiling

The costs of topsoiling are strongly influenced by topsoil availability, the distance it must be transported and the time and effort required to apply the topsoil. Estimates for this practice are presented here as square yards (yd²) to a depth of 4 in. If it is desired to convert these values to cubic yards (cu. yds.), the values may be multiplied by 9.

Range: \$1.25- \$2.25 yd²
Average: \$1.75 / yd².

Section Six Grass Swales

Introduction

A grassed swale, frequently referred to as grassed waterways, is a broad and shallow earthen channel vegetated with erosion resistant and flood tolerant grasses (Figure 2-1). Grass swales have traditionally been used as a low-cost storm water conveyance practice to safely move concentrated flow. As the focus of SWM programs expanded to include water quality considerations and pollutant reduction, the grassed swale has been perceived to represent a potentially important element of the treatment train (treatment system) approach to total SWM. Subcategories of the grass swale include:

- traditional grass swale or grassed waterway (Figure 6-1)
- grass swale with filter media (Figure 2-2)
- wet swale (Figure 2-3).



Figure 6-1 Grass Swale (VA DCR, 1999)

Figure 6-1 is a grass swale through a residential area. The flat slope encourages infiltration, and if designed properly, the ponding water should be gone within hours of runoff producing event.

As discussed in Section 3, innovative SWM approaches such as LID are using grassed swales to provide some additional hydrologic objectives. These include:

- design to reduce hydrologic regime alterations
- design to maintain groundwater recharge rates
- design to reduce impacts to receiving channels
- design to control peak discharge.

General design considerations and procedures for these applications were presented in Sections 3 and 4.

Grassed swales are being designed to convey stormwater runoff at a non-erosive velocity as well as enhance its water quality through infiltration, sedimentation and filtration. Check dams can be used within the swale to slow the flow rate, promote infiltration, and create small, temporary ponding areas. In Figure 6-2, the stone check dam in front of inlet creates a shallow ponding area to encourage infiltration and settling. In Figure 6-3, there is significant channel storage capacity created by check dams, and the notched center allows safe overflow without scour around sides. Grassed swales can provide effective control under light to moderate runoff conditions but their ability to control large storms is limited. Therefore, they are most applicable in low to moderate sloped areas or along highway medians as an alternative to ditches, and curb and gutter drainage (Boutiette and Duerring, 1994). Their performance diminishes sharply in highly urbanized settings, and they are generally not effective enough to receive construction stage runoff where high sediment loads can overwhelm the system (Schueler et al., 1992). Grassed swales are often used as a pretreatment measure for other downstream BMPs, particularly infiltration devices (Driscoll and Mangarella, 1990).



Figure 6-2 Grass Swale with Check Dam (VA DEC, 1999)

Grassed swales can be more aesthetically pleasing than concrete or rock-lined drainage systems, and are generally less expensive to construct and maintain. When swales are substituted for curbs and gutters, they can slightly reduce impervious areas and eliminate a very efficient pollutant accumulation and delivery system, because the roughness increases due to the swale results in decreased velocities (Ree, 1949). Low-sloped or un-mowed swale systems can create wetland acreage or "wet meadow" habitat, respectively. The disadvantages of this technique include the possibility of soggy or wet areas in medians, the potential for mosquito breeding areas, the possibility of erosion and channelization over time, and the need for more right-of-way as compared to a storm sewer system (UDFCD, 1999).

When properly constructed, inspected, and maintained, the grass swale represents a sustainable BMP design with no known limit on its life expectancy.



Figure 6-3 Grass Swale with Check Dams (VA DEC, 1999)

Site Considerations

The suitability of a swale at a site will depend on land use, size of the area serviced, soil type, slope, and imperviousness of the contributing watershed as well as the dimensions and slope of the swale system (Schueler et al, 1992). In general, swales can be used to serve small areas, less than 4 ha (10 acre) in size, with slopes no greater than 5%. The seasonal high water table should be at least 0.3 to 0.6 m (1 to 2 ft) below the surface and buildings should be at least 3 m (10 ft) from the site (GKY and Associates, Inc., 1991). Use of natural topographic lows is encouraged, and natural drainage courses should be regarded as significant local resources to be kept in use (Khan, 1993). Drainage patterns and contributing areas can be determined from contour maps generated from surveys. Existing drainage facilities, conveyance system locations, and grading plans can be found in Hydraulics Reports from previous projects in the vicinity or from plans for the existing roadway (Washington State Department of Transportation, 1995). Roadside ditches should be regarded as potential sites as well (Khan, 1993). The suitability of swales may be reduced as the number of driveway culverts increases, and they

are not especially compatible with extensive sidewalk systems. One of the most appropriate layout of swales in combination with roads and sidewalks is to place the swale between two impervious ground covers (NVPDC, 1992). This placement provides water quality benefits as well as a safety barrier between pedestrians and vehicles.

Soil Permeability

Swale systems require dry soils with good drainage and high infiltration rates for better pollutant removal (Yousef et al., 1985). Hayes et al. (1994) conducted model studies and field data collection showing that infiltration is the most important factor in trapping clay size particles. Since these particles are the active elements that contain absorbed ions, dry soils and high infiltration rates are essential to trapping nutrients absorbed by the clays. Further, since infiltrated water in vegetative filters carries nutrients and toxics into the soil as shown in field data collected by Barfield et al. (1992), infiltration is critically important to trapping dissolved solids. The suitable textural classes of the soil underlying the swale are sand, loamy sand, sandy loam, loam, and silt loam. Heavy clays that would not support good vegetation and would promote ponding should be avoided. Soil types in the area can be obtained through soil survey maps developed by local soil conservation services, or soil samples can be collected and analyzed in a lab.

Topography and Slope

The topography of the site should permit the design of a channel with a slope and cross sectional area sufficient to maintain an appropriate flow velocity. Site topography may also dictate a need for additional structural controls.

Erosion resistance is an important design consideration, and is dependent on slope, soil type and vegetative cover. Criteria for these factors are well established and are presented in Table 6-1 (Ree, 1949 and Temple et al., 1987).

Table 6-1 Guide for Selecting Maximum Permissible Swale Velocities for Stability (Ree, 1949 and Temple et al., 1987)

Cover Type	Slope (%)	Maximum Velocity (m/s [ft/s])	
		Erosion-resistant soils	Easily-eroded soils
Kentucky blue grass Tall fescue	0 - 5	1.8 (6)	1.5 (5)
Kentucky bluegrass Rye grasses Western wheat-grass	5 - 10	1.5 (5)	1.2 (4)
Grass - legume Mixture	0 - 5 5 - 10	1.5 (5) 1.2 (4)	1.2 (4) 0.9 (4)
Red fescue	0 - 5	0.9 (3)	0.8 (2.5)

Trapping of sediment is also an important design objective that is based on flow velocity which is dependent on slope, discharge and vegetative density. Criteria were established by Hayes et al. (1984) and Barfield et al. (1988). In urban areas slopes are generally limited to 10%, but slopes up to 20% have been used for surface mining reclamation applications.

Trapping of nutrients is another typical design objective. Trapping of nutrients has been established by Hayes et al. (1980), Barfield et al. (1994) and other researchers to depend on soil infiltration rates. These depend on soil properties and residence time in the swale. Slope, vegetative retardance and the resultant flow velocity determine the residence time. Low gradient slopes can be used, however, if slopes are too flat, an under drain may be required to avoid standing water. Steep slopes increase flow velocity and decrease detention time, and may require energy dissipating and grade check (Khan, 1993). Steep slopes can also be managed through the use of a series of check dams to terrace the swale and reduce the slope to within acceptable limits. The use of check dams with swales also promotes additional infiltration.

Pollutant Removal

Pollutants are removed in swales by the filtering action of grass, deposition in low velocity areas, or by infiltration into the subsoil. The primary pollutant removal mechanism is through sedimentation of suspended materials. Therefore, SS and adsorbed metals are most effectively removed through a grassed swale. Removal efficiencies reported in the literature vary, but generally fall into the low to medium range, with some swale systems recording no water quality effects at all.

Table 6-2 presents the pollutant removal efficiencies for swale lengths of 61 m (200 ft) and 30 m (100 ft). Although research results varied, these data clearly indicate greater pollutant removal at longer swale lengths.

In general, the current literature reports that a well-designed, well-maintained swale system can be expected to remove 70% of TSS, 30% for total phosphorus (TP), 25% for total nitrogen (TN), and 50 to 90% for trace metals (Barret et al., 1993 and GKY and Associates, Inc., 1991). The nitrogen removals may be fairly optimistic, given that studies conducted by Yousef et al. (1985) and others produced negative nitrogen removal in many cases. It is theorized that the outwelling of nitrogen from grass clippings and other organic materials from the swale produced these results.

Seasonal differences in swale performance can be important. In temperate climates, fall and winter temperatures force vegetation into dormancy, thereby reducing uptake of runoff pollutants, and removing an important mechanism for flow reduction. Decomposition in the fall and the absence of grass cover in the winter can often produce an outwelling of nutrients, and exposes the swale to erosion during high flows, increasing sediment loads downstream. Pollutant removal efficiencies for many constituents can be markedly different during the growing and dormant periods (Driscoll and Mangarella, 1990).

Table 6-2 Swale Pollutant Removal Efficiencies (Barret et al., 1993, Schueler et al, 1991, Yu,1993, and Yousef et al., 1985)

Design	Pollutant Removal efficiencies (%)							
	Solids	Nutrients		Metals			Other	
	TSS	TN	TP	Zn	Pb	Cu	Oil & Grease	COD**
61-m (200-ft) swale	83	25*	29	63	67	46	75	25
30-m (100-ft)swale	60	-*	45	16	15	2	49	25

*Some swales, particularly 100-ft systems, showed negligible or negative removal for TN.

**Data is very limited.

Performance Factors

Several other factors may influence expected removal rates, including soil and vegetation type, runoff pollutant constituents, flow rate and runoff contact with the swale, and swale enhancements.

Soil Type

Swales are typically not effective in removing soluble pollutants. However, under very low flow velocities, soils with high infiltration rates can remove low loads of soluble pollutants. Yousef et al. (1985) reported consistently higher removal rates for all pollutants, particularly solubles, at a site in Florida where infiltration rates were at or above 38 mm/h (1.5 in/h).

Vegetation Type

Pollutant removal efficiencies of swales are related to flow retardance, vegetation density and the stiffness of grass blades, providing a "scrub brush" effect (Khan, 1993). Best removal rates have been achieved through dense turf grasses where a uniform blade height is maintained at least 50 mm (2 in.) above the design water depth. Grasses too short do not provide sufficient flow reduction or pollutant filtration; grasses too long tend to bend and flatten, allowing the runoff to skim over the bent grass, reducing flow retardance and filtration.

Pollutant Constituents

Removal efficiency varies with the constituents passing through the swale system. Best results will be achieved if runoff is characterized prior to installation, when the appropriateness of the swale can be determined or design modifications can maximize swale performance for the targeted constituents. In addition, heavy loads of oil, grease and sediments can damage swale vegetation. If these constituents are abundant in runoff, it may be necessary to place oil/water separators or sediment traps upstream from the swale (Khan, 1993).

Flow Rate and Runoff Contact

To maximize pollutant removal efficiency, the time runoff is in contact with the vegetated swale should be maximized, and channelization of high flows should be avoided. High-order contact with swale vegetation for flow reduction, plant uptake and infiltration into soils is needed. When appropriate, swale design should incorporate flow spreading structures such as shallow weirs, stilling basins or perforated pipes. Increased removal of solubles, particularly nutrients and soluble metals, has been correlated with reductions in flow rate, and increased contact time with swale vegetation (Yousef et al., 1985).

Use of Check Dams

Structural enhancements, such as check dams, level the grade line, decrease the chances of erosion, and increase contact time for the flow to infiltrate through the soil. Swale check dams are often constructed of railroad ties or stone berms; earthen check dams should be avoided as they tend to erode, leading to additional sediment loads downstream and/or wash out of the dam. No performance data exists on the effect of check dams in swales, however, the additional detention and trapping capability provided is projected to improve pollutant removal (Schueler et al., 1992).

Design Guidance

The design of open channels usually involves the application of two fundamental equations: the continuity equation and Manning's equation. For any flow, the discharge Q at a channel section is expressed by the continuity equation which is expressed as follows (Chow, 1959):

$$Q = VA \tag{6-1}$$

where: V = the mean velocity, and

A = the flow cross-sectional area normal to the direction of the flow.

Manning's equation, developed by the Irish engineer Robert Manning in 1889, is expressed in the following form:

$$V = (\text{Const}_6 / n) R^{2/3} S^{1/2} \quad (6-2)$$

where: **V** = the mean velocity, in m/s (ft/s),
R = the hydraulic radius in m (ft),
S = the slope of the energy line,
Const₆ = 1.0 for metric and 1.49 for English units, and
n = the coefficient of roughness.

The basic design procedure for a swale system was developed by Chow (1959). There are a number of ways to apply the design procedure, depending on the order in which the steps are performed and the variables established at the beginning of the process.

A number of approaches for the sizing and design of grass swales have been documented in the literature. A summary of selected approaches that provide varying degrees of complexity and design robustness are presented below, and include the following approaches:

- the Denver Urban Drainage and Flood Control District Approach (UDFCD, 1999)
- the Washington State Approach (after Horner 1988)
- the IDEAL model procedure (Hayes et al., 2001).

Denver Urban Drainage and Flood Control District Procedure

The Denver Urban Drainage and Flood Control District has included a design procedure for the use of a grass swales, as shown in Figure 6-4 in its Urban Stormwater Drainage Criteria Manual (UDFCD, 1999). The following steps outline the grass buffer design procedure and criteria. Figure 6-5 is a schematic of the facility and its components.

The following steps outline the grass swale design procedure and criteria.

Step 1: Design Discharge

Determine the 2-yr flow rate in the proposed grass swale using hydrologic procedures approved by local regulatory authority.

Step 2: Swale Geometry

Select geometry for the grass swale. The cross section should be either trapezoidal or triangular with side slopes flatter than 4:1 (Horizontal/Vertical), preferably 5:1 or flatter. The wider the wetted area of the swale, the slower the flow.

Step 3: Longitudinal Slope

Maintain a longitudinal slope for the grass swale between 0.2 and 1.0%. If the longitudinal slope requirements can not be satisfied with available terrain, grade control checks or small drop structures must be incorporated to maintain the required longitudinal slope. If the slope of the swale exceeds 0.5% in semi-arid areas of Colorado, the swale must be vegetated with irrigated turf grass.



Figure 6-4 Typical Grass Swale (UDFCD, 1999)

Step 4: Flow Velocity and Depth

Calculate the velocity and depth of flow through the swale. Based on Manning’s equation and a Manning’s roughness coefficient of $n = 0.05$, find the channel velocity and depth using the 2-yr flow rate determined in Step 1. Maximum flow velocity of the channel shall not exceed 1.5 ft/s and the maximum flow depth shall not exceed 2 ft at the 2-yr design flow rate. If these conditions are not attained, repeat steps 2 through 4, each time altering the depth, bottom width or longitudinal slopes until these criteria are satisfied.

Step 5: Vegetation

Vegetate the swale with dense turf grass to promote sedimentation, filtration, and nutrient uptake, and to limit erosion through maintenance of low flow velocities.

Step 6: Street and Driveway Crossings

If applicable, small culverts at each street crossing and/or driveway crossing may be used to provide onsite stormwater capture volume in a similar fashion to a small extended detention basin (if adequate volume is available).

Step 7: Drainage and Flood Control

Check the water surface during larger storms such as the 5-yr through the 100-yr floods to ensure that drainage from these larger events is being handled without flooding critical areas, or residential, commercial and industrial structures.

Design Example 6.1: Grass Swale Design Procedure Form

The UDFCD has developed a series of simplified design forms that provide a uniform means of documenting the design procedure. A completed form follows as a design example.

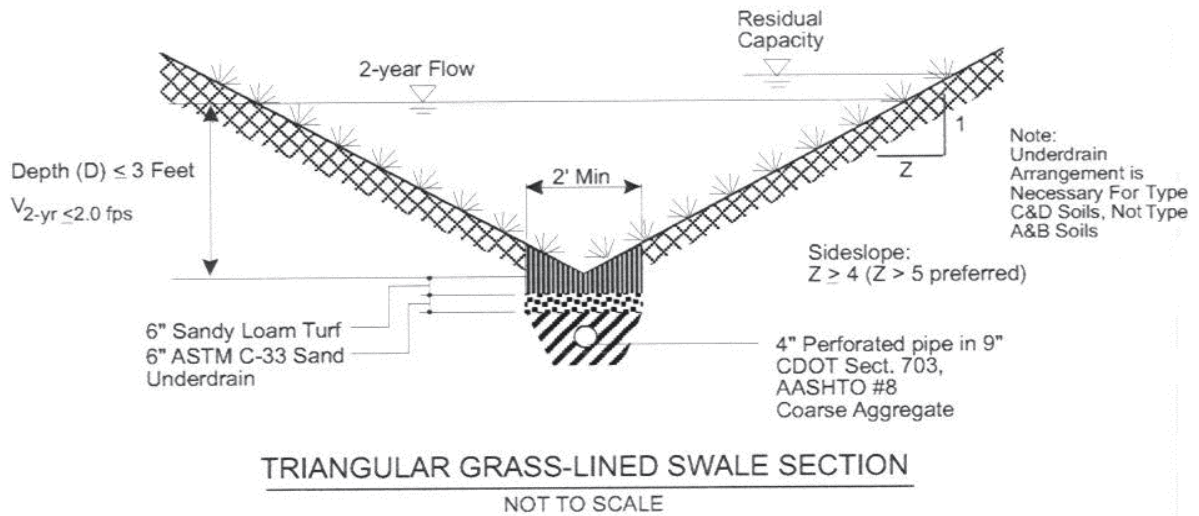
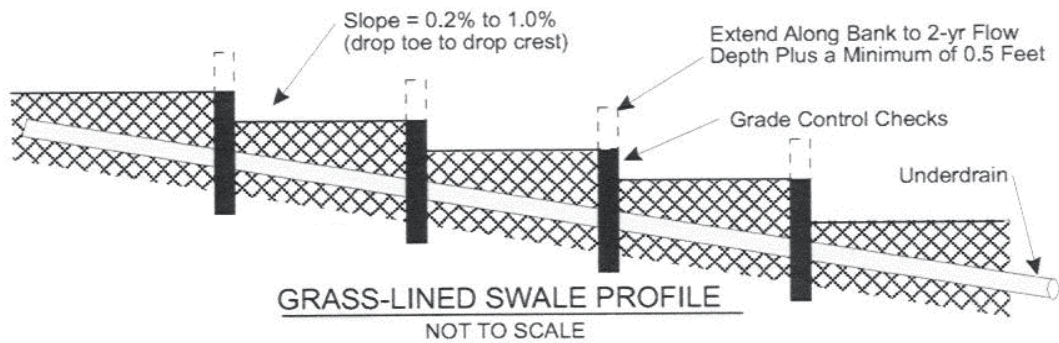
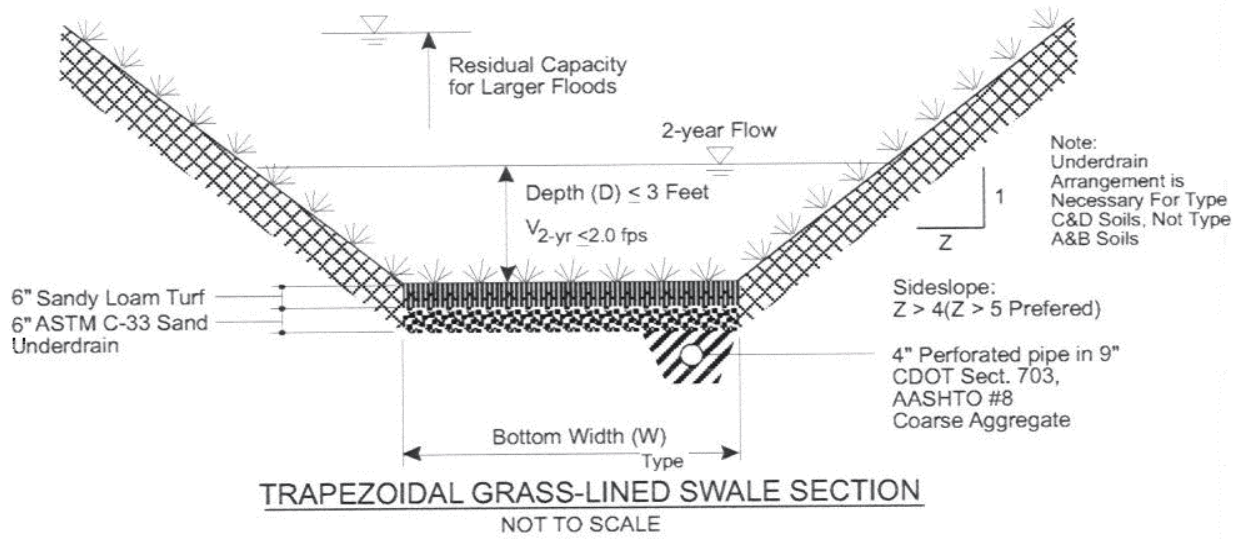

Figure 6-5 Grass Swale Profile and Section (UDFCD, 1999)

This procedure was developed with the aid of local government and engineers in and for the Colorado High Plains environment. It was designed to provide an easy to follow protocol for a particular region of the country. As such, it can be observed that this design approach is also subject to the same significant limitations as the previously discussed for VFS methods. It does not take into account site specific criteria like the particle size of the material or the infiltration rate of the soils. It will also over estimate the trapping efficiency of soils with low permeability and under predict the trapping efficiency of soils with high permeability. For these reasons, this and the other regional methods presented are limited as regional predictive design tools, and should not be used outside the region for which the original design guidance was intended.

Grass Swale Design Procedure Form (UDFCD, 1999)	
Company: _____	Designer: _____
Project: _____	Date: _____
Location: _____	
1. 2-Year Design Discharge (Total) 2-Year Design Flow Velocity (V_2 , 1.5 fps Maximum)	$Q_2 = \underline{5.0}$ cfs $V_2 = \underline{1.30}$ fps
2. Swale Geometry A) Channel Side slopes (Z , horizontal distance per unit vertical) B) 2-Year Design Flow Depth (D_2 , 2 feet maximum) C) Bottom Width of Channel (B)	$Z = \underline{4.0}$ (H:V) $D_2 = \underline{1.4}$ feet $B = \underline{0.0}$ feet
3. Longitudinal Slope A) Froude Number (F, 0.50 maximum, reduce V_2 until $F < 0.50$) B) Design Slope (S, Based on Manning's $n = 0.05, 0.1$ Maximum) C) Number of grade control structures required	$F = \underline{0.28}$ $S = \underline{0.0032}$ feet/feet _____ Number
4. Vegetation (Check the type used or describe "other") (Note: Must use irrigated turf grass if $S > 0.005$ in semi-arid areas of Colorado)	_____ Dryland Grass <input checked="" type="checkbox"/> Irrigated Turf Grass _____ Other _____
5. Outlet (Check the type used or describe "Other")	<input checked="" type="checkbox"/> Infiltration Trench w/ Under drain _____ Grated Inlet _____ Other _____
Notes: _____	

The Washington State Design Approach

Horner (1988) set forth a guide for bioretention in the publication: “Biofiltration for Stormwater Runoff Quality Control” for Washington State especially the Puget sound region. The following approach is derived from Federal Highway Administration Document “Evaluation and Management of Highway Runoff Water Quality” (Young et al., 1996) which was originally based on an adoption of Horner’s (1988) procedure and Washington State Department of Transportation (1995) procedures. The Federal Highway Administration procedures deviate from the original Washington State Approach, possibly to be more inclusive of other regions. Local practice and regulation may supercede some of the recommended procedures outlined below. A similar approach is detailed in the ASCE/WEF (1998) manual of practice.

Horner's procedure reversed Chow's order, designing first for capacity, to emphasize the promotion of biofiltration, rather than the simple conveyance of stormwater. The capacity analysis emphasizes the promotion of biofiltration, rather than transporting flow with the greatest possible hydraulic efficiency. It is based on criteria that promote sedimentation, filtration and other pollutant removal mechanisms. Because the criteria included a lower maximum velocity than permitted for stability, the biofilter dimensions usually did not have to be modified after a stability check. However, some of the tables presented here are from other sources than the original criteria set out by Horner (1988) and a stability check may require some modifications.

Several criteria should be kept in mind when beginning swale design. These provisions, presented in Table 6-3, have been developed through a series of evaluative research conducted on swale performance.

Table 6-3 Design Parameters for Swale (Adopted from Young et al., 1996)

Parameter	Design Criteria	Minimum Design Criteria
Hydraulic residence time	9 min	> 5 min
Design flow velocity	< 27 m ³ /s (0.9 ft ³ /s)	
Swale width	2.4 m (8 ft)	0.6 m (2ft)
Swale length	61 m (200 ft)	30 m (100 ft)
Swale slope	2 - 6 %	1 %
Side slope ratio (h:v)	4:1	3:1

Criteria at or below minimum values can be used when compensatory adjustments are made to the standard design. Specific guidance on implementing these adjustments will be discussed in the design section.

The reader is cautioned that this iterative design approach is also subject to some significant limitations. Like the previous method it does not take into account the particle size of the material or the infiltration rate of the soils. Therefore it will tend to over predict the trapping efficiency of soils with low permeability and under predict the trapping efficiency of soils with high permeability. For these reasons this method is limited as a predictive design tool and should be used with caution. The limitations of this approach are addressed in the IDEAL design approach presented in this section, which can also be used to generate and verify simplified design criteria.

The following ten steps are recommended to be conducted in order to complete a swale design.

1. determine design flow rate to the system
2. determine the slope of the system
3. select a swale shape
4. determine required channel width

-
5. calculate the cross-sectional area of flow
 6. calculate the velocity of channel flow
 7. calculate swale length
 8. select swale location based on the design parameters
 9. select a vegetation cover for the swale
 10. check for swale stability.

Procedures for each task are discussed in detail below.

Step 1: Determine Design Flow Rate

Preliminary design for most swales begins with estimating the design flow rate (Q) for the design storm. The design storm is subject to local regulations and thus may vary on a State or local basis. The State of Maryland (MDE, 2000) recommends that swales designed for water quality control be designed to control a 1 in. runoff event. Horner (1988) recommends that for the Pacific northwest region, a 2-yr 24-hr duration design storm be used. Section 3 of this volume provided guidance on the computation of design discharges. An important point to note is that unless runoff from larger events are designed to bypass the swale, consideration must be given to the control of channel erosion and destruction of vegetation. A stability analysis for larger flows (up to the 100-yr, 24-hr) must be performed. Runoff quantity and design flows can be estimated using a variety of mathematical, graphical, and computerized techniques. The reader is referred to Volume 1 for additional guidance on estimating runoff volumes.

Step 2: Determine the Slope of the System

The slope of the swale will be somewhat dependent on where the swale is placed, but should be between the stated criteria of 1 and 5%. With slopes less than 2%, the use of under drainage may be required (Washington State Department of Transportation, 1995). If the slope is between 4 and 6%, vertical drops (150 to 300 mm [6 to 12 in.]) will be required through check dams at 15 to 30 m (50 to 100 ft) intervals. Energy dissipating and flow spreading riprap will be needed across check dams and for a short distance downstream of the toe drops. If the slope is greater than 6%, the grade will need to be traversed to reduce the slope of any segment to below 4%, preferably, or to below 6% with check dams (Horner, 1988).

Step 3: Select a Swale Shape

Normally, swales are designed and constructed in a trapezoidal shape, although alternative designs can be parabolic, rectangular, and triangular. Trapezoidal cross-sections are preferred because of relatively wider vegetative areas and ease of maintenance (Khan, 1993). They also avoid the sharp corners present in V-shaped and rectangular swales, and offer better stability than the vertical walls of rectangular swales. A parabolic shape is best for erosion control, but is hard to construct. Trapezoidal shapes tend to become parabolic over time due to the growth of vegetation and settlement of solids (Horner, 1988). Rectangular swales are only used in very confined spaces. Reinforcement specifications for the side walls in rectangular swales should conform with the local government standards. Unless space is a problem, the design process should begin assuming a trapezoidal shape (Khan, 1993). The remainder of the design process assumes that a trapezoidal shape has been selected.

Step 4: Determine Required Channel Width

Estimates for channel width for the selected shape can be obtained by applying Manning's equation (equation 6-2). A Manning's n value of 0.2 is recommended for routine swales that will be mowed with some regularity. For swales that are infrequently mowed, a Manning's n value of 0.24 is recommended. A higher n value can be selected if it is known that vegetation will be very dense (Khan, 1993). Table 5-3 and Figure 5-9 provide a range of n values. Figure 6-6 presents channel geometry and equations for a trapezoidal swale, the most frequently used shape.

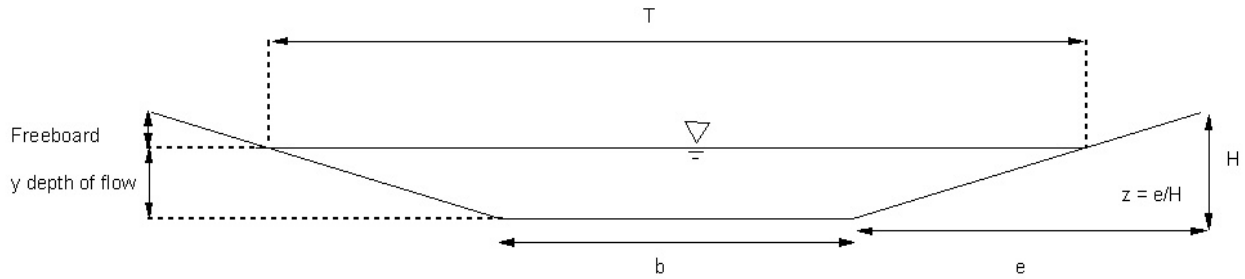

Figure 6-6 Channel and Flow Geometry for a Trapezoid Swale

Side Slope: $Z = e / H$ (6-3)

Cross Sectional Area: $A = by + zy^2$ (6-4)

Top Width: $T = b + 2Hz$ (6-5)

Wetted Perimeter: $P = b + 2y\sqrt{1 + z^2}$ (6-6)

Hydraulic Radius: $R = A / P = (by + zy^2) / [b + 2y\sqrt{1 + z^2}]$ (6-7)

Approximation: $R \approx y$, when $b \gg y$ and $3 < z < 10$ (6-7a)

Swale depth: $H = y + \text{freeboard}$ (6-8)

where:
 y = flow depth,
 b = bottom width, and
 e = side width of trapezoidal channel.

Manning's equation (6-2) can be solved for flow by combining with the continuity equation (6-1). Substituting the approximation 6-7a into equations 6-4 and 6-7, and then substituting into Manning's equation for flow, the bottom width, b , for the trapezoid swale can be computed using the following approximation:

$$b = (Qn / y^{1.67} S^{0.5}) - zy \quad (6-9)$$

Equation 6-9 is an approximation based on the approximation of equation 6-7a. The bottom width of the trapezoid cannot be solved directly so the approximation has been used to avoid an iterative process; however, with the advent of the spreadsheet with iterative capabilities and the ability to vary only certain variables, it is recommended that the approximation not be used. If the approximation of equation 6-7a is used, the side slope (z) used should be at least 3:1 (horizontal:vertical) and width, b , should be checked against A , equation 6-4, for design and peak flow (this is detailed

in the example below). *This approximation should not be used directly as it may underestimate peak velocity and peak flow.*

Typically, flow depth, y , is set at 75 to 100 mm (3 to 4 in.). Flow depth can also be estimated by subtracting 50 mm (2 in.) from the expected grass height, if the grass type and the height it will be maintained is known. Values lower than 75 to 100 mm (3 to 4 in.) can be used, but doing so will increase the computed width (T or b) of the swale (Washington State Department of Transportation, 1995). Flow depth is subject to a stability check as described below.

The computed bottom swale width should be between 0.6 to 2.4 m (2 to 8 ft). Relatively wide swales (those wider than 2.4 m [8 ft]) are more susceptible to flow channelization and are less likely to have uniform sheet flow across the swale bottom for the entire swale length. The maximum widths for swales is on the order of 3 m (10 ft), however widths greater than 2.4 m (8 ft) should be evaluated to consider the effectiveness of the flow spreading design used, and the likelihood of maintaining evenness in the swale bottom. A practical minimum swale width for trapezoidal swales should also be established for ease of maintenance, e.g., to facilitate swale mowing with standard lawn mowers. Therefore, if b for a trapezoid swale is greater than 2.4 m (8 ft), investigate either the (a) probability for channelization given flow spreader device(s) to be used and swale maintenance practices, or (b) methods by which the design flow (Q) can be reduced. Since length may be used to compensate for width reduction (and vice versa) so that the area is maintained, the swale width can be arbitrarily set to 2.4 m (8 ft) to continue with the analysis. If $b < 0.6$ m (2 ft), set $b = 0.6$ m (2 ft) and continue. Narrower widths can be used if space is very constrained. Sometimes when the flow rate is very low, the equation above can generate a negative value for b . Since this is not possible, the bottom width (b) should be set to 0.3 m (1 ft) when this occurs.

Step 5: Calculate Cross-Sectional Area of Flow

Compute the cross-sectional area (A) for the design flow, using equation 6-4.

Step 6: Calculate the Velocity of the Channel Flow

Using the continuity equation (6-1), the channel flow velocity can be calculated. The channel flow velocity should be less than 0.27 m/s (0.9 ft/s) to prevent grasses from being flattened, which reduces filtration. A velocity lower than this maximum value is recommended to achieve the 9-min hydraulic residence time criterion, particularly in shorter swales (at $V = 0.27$ m/s, a 148 m swale is needed for a 9-min hydraulic residence time and a 82 m swale for a 5-min residence).

If the value V suggests that a longer swale will be needed than space permits, investigate how the design flow Q can be reduced, or increase flow depth (y) and/or swale bottom width (b) up to the maximum allowable values and repeat the analysis.

Step 7: Calculate Swale Length

Compute the swale length (L) using the following equation:

$$L = Vt_r (60s / min) \tag{6-10}$$

where: t_r = Hydraulic residence time (in minutes).

Use $t_r = 9$ min for this calculation. Swale length may be a matter of local regulation, however length is directly related to achieving the goal of a 9-min hydraulic residence time. This criterion has been shown to be the optimum value for good removal of particulates, oil, and grease. Performance data from research has indicated that shorter residence times cause reduction in pollutant removal rates. Longer times may be required if expected pollutant removal efficiency for solids is to exceed 80%.

If a biofilter length greater than the space will permit results, investigate how the design flow Q can be reduced or increased by increasing flow depth (y) and/or swale width (b) up to the maximum allowable values and repeat the analysis. If all of these possibilities are checked and space is still insufficient, t_r can be reduced, but to no less than 5 min. If the computation results in L less than 30 m (100 ft), set $L = 30$ m and investigate possibilities in width reduction. This is possible through recalculating V at the 30-m length, recalculating A , and ultimately adjusting the swale width b using the appropriate equation.

Step 8: Select Swale Location

Options for swale locations may be limited, or may be decided through processes outside the control of the designer. If this is the case, swale geometry should be maximized by the designer, using the above equations, and given the area to be utilized. If the location has not yet been chosen, it is advantageous to compute the required swale dimensions and then select a location where the calculated width and length will fit. If locations available cannot accommodate a linear swale, a wide-radius curved path can be used to gain length. Sharp bends should be avoided to reduce erosion potential. Regardless of when and how site selection is performed, consideration should be given to the following site criteria:

Soil Type

Soil characteristics in the swale bottom should be conducive to grass growth. Soils that contain large amounts of clay cause relatively low permeability and result in standing water, and may cause grass to die. Where the potential for leaching into potable groundwater supply exists, the swale bottom may need to be sealed with clay to protect from infiltration into the resource. Compacted soils will need to be tilled before seeding or planting. If topsoil is required to facilitate grass seeding and growth, use 150 mm (6 in.) of the following recommended topsoil mix: 50 to 80% sandy loam, 10 to 20% clay, and 10 to 20% composted organic matter (exclude animal waste).

Slope

The natural slope of the potential location will determine the nature and amount of regrading, or if additional measures to reduce erosion and/or increase pollutant removal are required. Biofilters should be graded carefully to attain uniform longitudinal and lateral slopes, and to eliminate high and low spots. If needed, grade control checks should be provided to maintain the computed longitudinal slope and limit maximum flow velocity (UDFCD, 1999).

Natural Vegetation

The presence and composition of existing vegetation can provide valuable information on soil and hydrology. If wetland vegetation is present, inundated conditions may exist at the site. The presence of larger plants, trees and shrubs, may provide additional stabilization along the swale slopes, but also may shade any grass cover established. Most grasses grow best in full sunlight, and prolonged shading should be avoided. It is preferable that vegetation species be native to the region of application, where establishment and survival have been demonstrated.

Step 9: Select Vegetative Cover

A dense planting of grass provides the filtering mechanism responsible for water quality treatment in swales. In addition, grass has the ability to grow through thin deposits of sediment and sand, stabilizing the deposited sediment, and preventing it from being resuspended in runoff waters. Few other herbaceous plant species provide the same density and surface per unit area. Grass is by far the most effective choice of plant material in swales, however not all grass species provide optimum vegetative cover for use in swale systems. Dense turf grasses are best for vegetative cover. Table 6-4 is provided as an example of the variations in grass species. A local horticulturist or the local cooperative extension can provide information on the recommended or optimum turf grass species most suitable to your area, based on suitability in terms of cold tolerance, heat tolerance, mowing height adaptation, drought tolerance, and maintenance cost and effort.

The type of grass cover can be selected at any earlier stage in the design process. Often if grass cover is known, optimum height can be established and flow depths can be set accordingly. In areas of poor drainage, wetland species can be planted for increased vegetative cover. Use wetland species that are finely divided like grass and relatively resilient. Use

of invasive species should be avoided to eliminate proliferation in the swale and downstream. Certain regions of the country are also encouraging the use of native over exotic species in planting specifications.

Table 6-4 Example Criteria for Turf Grass Cover (Young et al., 1996)

	Cold Tolerance	Heat Tolerance	Mowing Height	Drought Tolerance	Maintenance
High	Creeping bentgrass Kentucky bluegrass Red fescue Colonial bentgrass Highland bentgrass	Zoysia grass Hybrid bermuda grass Common bermuda grass St Augustine grass Kikuyu grass	Tall fescue	Hybrid bermuda grass Zoysia grass Common bermuda grass	Creeping bentgrass Dichondra
		Tall fescue Dichondra Creeping bentgrass	Red fescue Kentucky bluegrass Perennial ryegrass Weeping alkali grass	St Augustine grass Kikuyu grass	Hybrid bermuda grass
		Kentucky bluegrass	St. Augustine grass Common bermudagrass		Kentucky bluegrass Colonial bentgrass Perennial ryegrass
	Tall fescue Weeping alkali grass	Highland bentgrass Perennial ryegrass Colonial bentgrass	Dichondra Kikuyugrass Colonial bentgrass Highland bentgrass Zoysiagrass	Tall fescue Red fescue	St. Augustine grass Highland bentgrass Zoysia grass
			Hybrid bermudagrass		
Low	Dichondra Zoysia grass Common bermuda grass Hybrid bermuda grass Kikuyu grass St. Augustine grass	Weeping alkaligrass Red fescue	Creeping bentgrass	Kentucky bluegrass Perennial ryegrass Highland bentgrass Creeping bentgrass Colonial bentgrass Weeping alkaligrass Dichondra	Tall fescue Common bermuda grass Kikuyu grass

Woody or shrubby plants can be used for landscaping on the edge of side slopes, but not in the swale treatment area. Trees and shrubs can provide some additional stabilization, but also mature and shade the grass. In addition, leaf or needle drop can contribute unwanted nutrients, create debris jams, or interfere with water flow through the system. If landscape plantings are to be used, selection and planting processes should be carefully planned and carried out to avoid these potential problems.

Step 10: Check Swale Stability

The stability check is performed for the combination of highest expected flow and least vegetation coverage and height. Stability is normally checked for flow rate (Q) for the 100-yr, 24-h storm unless runoff from larger such events will bypass the swale. Q can be determined using the same methods mentioned for the initial design storm computation.

The maximum velocity, V_{max} in m/s, that is permissible for the vegetation type, slope and soil conditions should be obtained. Table 6-1 provides maximum velocity data for a variety of vegetative covers and slopes.

The estimated degree of retardance for different grass coverage ("good" or "fair") should be obtained for the selected vegetation height. Estimation should be based on coverage and height will first receive flow, or whenever coverage and height are at their lowest. Table 6-5 provides qualitative degree of retardance for coverage and grass height.

Table 6-5 Grass Coverage, Height, and Degree of Retardance*

Average Grass Height (mm [inches])	Degree of Retardance
Coverage = "Good"	
> 760 (30)	A. Very high
280 - 610 (11-24)	B. High
150 - 270 (6-10)	C. Moderate
50 - 150 (2-6)	D. Low
>50 (>2)	E. Very low
Coverage = "Fair"	
> 760 (30)	B. High
280 - 610 (11-24)	C. Moderate
150 - 270 (6-10)	D. Low
50-150 (2-6)	D. Low
>50(>2)	E. Very low

*from Horner, 1988, based on Chow, 1959.

Select a trial Manning's n value for poor vegetation cover and low height. A good initial choice is $n = 0.04$. Using the alphabetic code assigned for the degree of retardance and the chosen n value, consult the graph in Figure 5-9 to obtain a first approximation for VR (velocity times hydraulic radius).

The graph in figure 5-9 was derived based on English units. For precision, the VR value obtained from the graph, in units of ft^2/s , should be converted to metric units by multiplying by a factor of 0.09290 to obtain VR in m^2/s . After conversion, compute the hydraulic radius, using the V_{max} determined for vegetation type and slope, by applying the following equation:

$$R = VR / V_{max} \tag{6-11}$$

$$VR = (R^{1.67} S^{0.5}) / n \tag{6-12}$$

Once the actual VR is determined, compare this value with the first approximation for VR obtained through Figure 5-9. If they do not agree within 5%, adjust Manning's n value and repeat the process until acceptable agreement is reached. If $n < 0.033$ is needed to get agreement, set $n = 0.033$, solve VR again using Manning's equation above, and proceed.

The actual velocity for the final design conditions should be computed using the following equation:

$$V = VR / R \quad (6.13)$$

The actual velocity V should be less than or equal to the maximum value obtained from Table 6-1. The area required for stability should be computed using the continuity equation (6-1).

The area value obtained in this procedure should be compared with the area value obtained in the design flow analysis. If less area is required for stability than is provided for design flow, the design is acceptable. If more area is required for stability, use the area value obtained in the stability analysis to recalculate channel dimensions and recalculate the depth of flow, solving equation 6-4 for y .

This stability flow depth, if needed, should be compared to the depth used in the design flow. The larger of the two values should be used, plus 0.3 m of freeboard, to obtain the channel depth (equation 6-8).

A final check for capacity should be performed based on the stability check and the maximum vegetation height and cover to ensure that capacity is adequate if the largest expected event coincides with the greatest retardance. Use Manning's equation with Manning's n value used for design flow and the calculated channel dimension (including freeboard) to compute the flow capacity of the channel. If the flow capacity is less than the flow rate of the stability check, increase the channel cross-sectional area as needed for this conveyance, and specify the new channel dimensions.

Horner (1988) advocated using a parabolic shape for design even if design a trapezoidal shape is initially used in construction. A check using the parabolic shape may give an indication of performance at some later date.

If there is insufficient space for the biofilter as designed, possibilities include dividing the flow among several swales, installing detention to control release rate upstream, increasing longitudinal slope, increasing side slopes, increasing vegetation height and design depth of flow (design should ensure vegetation remains standing during design flow) and reducing developed surface area to reduce runoff coefficient value and gain space for biofiltration (Horner, 1988).

Design Example 6.2: Trapezoidal Grassed Swale

Find: The appropriate swale dimensions for design flow, stability and capacity.

Given: Flow rate (Q) for the 2-yr, 24-h storm is $0.014 \text{ m}^3/\text{s}$ ($0.5 \text{ ft}^3/\text{s}$) and is $0.045 \text{ m}^3/\text{s}$ ($1.6 \text{ ft}^3/\text{s}$) for the 100-yr, 24-h storm. The longitudinal slope is 2%, the side slope (z) is 3, and vegetation will be one of the recommended grass mixes. The winter grass height is determined to be 125 mm (5 in) and the design flow depth is 0.076 m (3 in.). Since the swale will be mowed regularly, a Manning's n value of 0.2 should be used.

Solution:

Step 1. Determine the bottom width (b) for the trapezoid swale using equation 6-9 based on the approximation of R . y (equation 6-7):

$$b = (0.014)(0.2) / \left[(0.076)^{2/3} (0.02)^{1/2} \right] - (3)(0.076)$$

$$b = 1.2 \text{ m} (4 \text{ ft})$$

Step 2. The cross sectional area is calculated using equation 6-4:

$$A = (1.22)(0.076) + 3(0.076)^2 = 0.11m^2 (1.19ft^2)$$

Step 3. Determine the flow velocity in the channel using the continuity equation (6-1):

$$V = 0.014 / 0.11 = 0.13 m / s (0.42 ft / s)$$

Because the computed velocity, **V**, is less than the maximum 0.27 m/s (0.9 ft/s), the design can proceed.

Step 4: Compute the required length of the swale using equation 6-10:

$$L = (0.13)(60)(9) = 70 m (227 ft)$$

Because **b** is less than the maximum value, it may be possible to reduce the length (**L**) by increasing **b**. Set **L** = 55 m (180 ft) and solve equation 6-10 for velocity:

$$V = 55 / [(60)(9)] = 0.10 m / s (0.33 ft / s)$$

The cross sectional area of flow is re-calculated using the continuity equation (6-1):

$$A = 0.014 / 0.10 = 0.14 m^2$$

Then by substituting variables in equation 6-9, solve for **b**:

$$b = [0.14 - (3)(0.076)^2] / 0.076 = 1.6m (5.2ft)$$

Step 5: Check for stability at the computed dimensions:

First calculate **Q** for the 100-yr, 24-h storm. Base the check on a grass height of 76 mm (3 in.) with "fair" coverage. From Table 5-5, the degree of retardance is category D. Assume soil analysis has established soils as erosion resistant, and the maximum velocity (**V_{max}**) is 1.5 m/s (5 ft/s). Select a trial Manning's **n** value of 0.04 which corresponds to a **VR** value (velocity times hydraulic radius) of 3 using Figure 5-9. Convert the **VR** value from English to metric units:

$$VR_{metric} = VR_{English} \times 0.0929 = 3 ft^2 / s \times 0.0929 = 0.28 m^2 / s$$

Calculate the hydraulic radius (**R**) using the following equation using equation 6-11:

$$R = 0.28 / 1.5 = 0.19 m (0.6 ft)$$

Using the computed hydraulic radius, obtain the actual **VR** by using equation 6-12:

$$VR = (0.19)^{1.67} (0.02)^{0.5} / 0.04 = 0.21 m^2 / s (2.24 ft^2 / s)$$

In this example, the estimated **VR** value is not within 5% of the computed **VR** value above. If a new trial Manning's **n** value of 0.038 is used, referring back to Figure 5-9, the new estimated **VR** = 0.37 m²/s (4 ft²/s), the recalculated **R** from

equation 6-10 is 0.25 m (0.82 ft), and the recalculated **VR** from equation 6-10 is 0.37 m²/s (4 ft²/s). The new value is within 5% of the estimated value, and the stability check can proceed.

The actual velocity for the new design is re-computed using equation 6-13:

$$V = 0.37 / 0.25 = 1.48 \text{ m / s } (4.86 \text{ ft / s})$$

The actual velocity is less than the estimated maximum velocity of 1.5 m/s (5 ft/s) from Table 6-1 and the stability check can proceed.

Calculate the cross-sectional area to test stability using the continuity equation (6-1):

$$A = 0.045 / 1.48 = 0.030 \text{ m}^2 (0.34 \text{ ft}^2)$$

The stability area of 0.030 m² (0.34 ft²) is less than the original calculated flow area of 0.14 m² (1.52 ft²) and the capacity check can proceed. If the stability area was larger, it would be necessary to select a new trial size for width and flow depth (based on space and other considerations) and recalculate the cross-sectional area of flow until this condition is met.

The channel dimensions, including freeboard, are used to compute the flow capacity of the channel. The greater of the two flow depths from the design flow or stability check should be used, in this case the flow depth at design flow can be used. Using equation 6-8:

$$H = 0.076 \text{ m} + 0.30 \text{ m} = 0.38 \text{ m} (1.25 \text{ ft})$$

Using Manning's equation, the Manning's **n** value selected in the design flow design, and the channel dimensions, recompute the flow capacity for the channel. Using equation 6-4 and (with **H** for **y**):

$$A = (1.6)(0.38) + (3)(0.38)^2 = 1.04 \text{ m}^2 (11.79 \text{ ft}^2)$$

Using equation 6-6. substituted into equation 6-7 (with **H** for **y**):

$$R = A / P = 1.04 / [1.6 + (2)(0.38)(1 + 3^2)^{0.5}] = 0.26 \text{ m} (0.86 \text{ ft})$$

Using equations 6-1 and 6-2:

$$Q = (1.04)(0.26)^{0.667} (0.02)^{0.5} / 0.2 = 0.30 \text{ m}^3 / \text{s} (10.6 \text{ ft}^3 / \text{s})$$

The flow capacity of 0.30 m³/s of the swale is greater than the stability check rate, 0.045 m³/s (1.6 ft³/s) for the 100-yr storm, which was provided in the problem statement. If this was not the case, the cross-sectional area should be increased as needed for this conveyance, and new channel dimensions specified.

The top width can be calculated using equation 6-5. The final channel dimensions for the Trapezoidal swale are:

$$\begin{aligned} H &= 0.38 \text{ m (1.25 ft)} \\ T &= 3.88 \text{ m (12.7 ft)} \\ b &= 1.6 \text{ m (5.25 ft)} \\ z &= 3 \text{ and } S = 0.02. \end{aligned}$$

The IDEAL Model Analysis Procedures for Vegetative Biofilters

The IDEAL model provides a scientifically robust analytical procedure for the design of vegetative biofilters (Hayes et al., 2001). This model builds upon the earlier work on the design of VFS by Barfield and Hayes (1988), Hayes et al. (1984) and Haan et al. (1994). Routines involved in computing the effectiveness of vegetative biofilters including both VFS and grassed swales include hydraulic routing, sediment routing, and pollutant routing.

The IDEAL model is a relatively complex model compared to the design approaches described above and many regulatory agencies at the State and local level may not want to require this degree of complexity in BMP design. However, the method can also be used to verify the accuracy of simpler design methods for swales, and can also be useful to evaluate the cumulative effectiveness of BMP practices at the watershed scale.

The IDEAL model procedure for grassed filter strip and grass swale is presented in Section 5. A complete example problem of the vegetated filter strip was presented in Section 5. A brief example problem of the application of the IDEAL model to the design of a grass swale is presented below.

Example Problem 6.3: Hydraulic Design of a Bioswale

Design a trapezoidal bioswale to transmit a maximum flow of 30 ft³/s on a slope of 4%. Assume that the vegetation is Bermuda grass which is routinely mowed to a height of 0.2 ft and kept in good condition. Also assume that the bottom width is a minimum of 10 ft due to construction considerations and that side slopes of 5:1 will be used. The soil is a sandy loam soil.

Solution

1. Developing Input Values.

From Table 5-5 the retardance class is either B, C or D. Assume class C first and design for maximum stability. After that design is complete, additional flow capacity will be added, using the same bottom width and side slopes, to transport the flow if the storm occurs with a retardance class of B. The permissible velocity for this retardance class with good vegetation on sandy loam soil is 3.5 ft/s from Table 5-5. From Table 5-4 the *I* value for retardance class C for equation 5-18 is 5.601, thus:

$$n = \exp \left[5.601 \left(0.01329 \{ \ln(VR) \}^2 - 0.09543 \ln\{VR\} + 0.2971 \right) - 4.16 \right]$$

Using equations 6-4 and 6-7 (or formulations from Figure 5-8), the area and hydraulic radius for a trapezoidal channel are:

$$A = by + zy^2 = by + 5y^2$$

$$R = \frac{A}{P} = \frac{by + zy^2}{b + 2y\sqrt{z^2 + 1}} = \frac{by + 5y^2}{b + 2y\sqrt{5^2 + 1}} = \frac{by + 5y^2}{b + 10.19y}$$

Also, for a trapezoidal channel, the discharge given by Manning's equation (equation 6-2) is:

$$V = \frac{1.49}{n} R^{2/3} S^{1/2} = \frac{1.49}{n} R^{2/3} (0.2)$$

2. Solving for Dimensions of the Channel.

The equations above were programmed into a spreadsheet and solved to minimize the area subject to the constraints that the bottom width be \$ 10 ft, the area, **A**, be a minimum, and the velocity, **V**, be the allowable velocity of 3.5 ft/s for retardance class C. A solver within Excel was used for arriving at the solution. The following values were obtained with **Q** = 30 ft³/s:

$$b = 12.0 \quad y = 0.575 \quad VR = 2.70 \quad n = 0.0521$$

For situations where two retardance classes are applicable (for example mowed and unmowed grass), the channel should first be designed for stability based on the lower retardance and then additional depth added to the channel to accommodate the flow when the retardance increases. An analysis was made for the maximum depth, assuming retardance class B, which has a higher **n** value. For this case, the value for **l** in equation 5-18 is 7.643, as determined from Table 5-4. Using this value in the spreadsheet, the new depth would be 0.74 ft. After adding a freeboard of 0.3 ft or 20% of the depth, whichever is greater, the final design is **b** = 12.0 ft, and **y** = 1.04 ft.

Swale Enhancements

Check Dams

Check dams are utilized in swales for two reasons: to increase pollutant removal efficiency and/or to compensate for steep longitudinal slope. The dams should be installed perpendicular to the direction of flow and anchored into the slope of the channel. The side slopes of the check dams should be between 5:1 and 10:1 to facilitate mowing operations. The berm height should not exceed 0.6 m (2 ft) and water ponded behind the berm should infiltrate into the soils within 24 hr (Colorado Department of Transportation, 1992). Figure 6-7 shows an example of check dams erected at regular intervals to maintain a shallower, uniform slope (VA DEC, 1999). With this configuration, energy dissipating and flow spreading riprap is often used across check dams, and for a short distance downstream at the toe of the drops. Check dams should be spaced so that the toe of the upstream dam is at the same elevation as the top of the downstream dam. Check dams can be constructed using earth, riprap, gabions, railroad ties or pressure-treated wood logs. Figure 6-8 provides typical checkdam configurations for a riprap and a half round corrugated metal pipe check dam (VA DEC, 1999). For best performance, check dams should have a level upper surface, rather than the uneven surface of a riprap check dam. Earthen check dams are not recommended due to erosion potential and high maintenance effort.

Design Example 6.4: Grassed Swale with Check Dams

A swale needs to be designed for a row of houses in a residential development. Some additional computations need to be performed when using one or more check dams. Assume the following dimensions and hydrology have been obtained for a swale:

depth of swale = 0.3 m (1 ft)
 swale bottom width = 3 m (10 ft)
 side slope ratio = 3:1
 longitudinal slope = 0.03
 length of swale = 105 m (347 ft)
 top width = 4.9 m (16 ft)

The number of check dams required for maximum ponding needs to be computed, by first determining the length behind each check dam:

$$L_d = H_d / s \quad (6-14)$$

where: L_d = the length behind the check dam,
 H_d = the depth of the swale, and
 s = longitudinal slope.

Solving equation 6-14:

$$L_d = 0.3 / 0.03 = 10 \text{ m (33 ft)}$$

The number of check dams required is calculated by the following simple relationship between total swale length, L , and L_d :

$$\# \text{ of check dams} = L / L_d \quad (6-15)$$

Solving equation 6-15:

$$\# \text{ of check dams} = 105 / 10 = 10$$

The top width (T) for each check dam is computed by substituting H_d equation 6-5 :

$$T = b + 2H_d z$$

$$T = 3 + 2 \times 0.3 \times 3 = 4.9 \text{ m (16 ft)}$$

Level spreaders

Level spreaders are diminutive check dams used to provide a uniform flow distribution across the swale bottom. The hydraulic design of the swale assumes a uniform distribution, which is difficult to attain without the aid of level spreading devices. The device, placed at the swale inlet, may consist of a shallow weir across the channel bottom, a stilling basin, or perforated pipe. A sediment clean-up area should be provided for ease of maintenance.

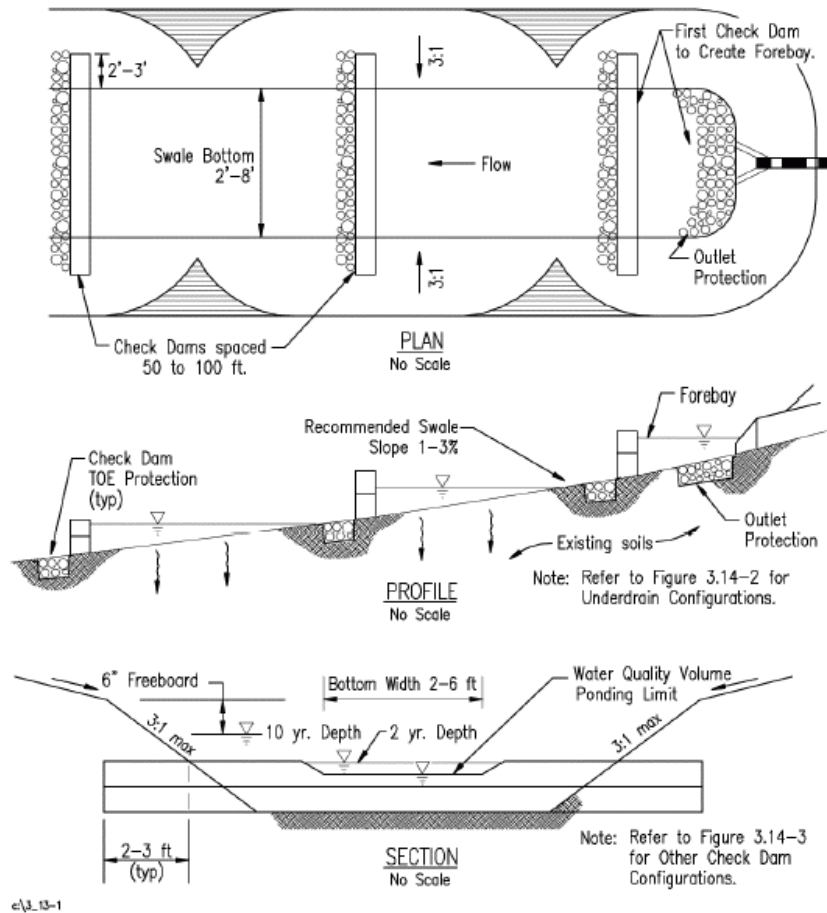

Figure 6-7 Typical Swale with Check Dam Configuration (VA DEC, 1999)

Flow Bypass

Flow bypass should be considered for high flow events to avoid erosion and channelization. Flow bypass also allows diversion of flows during swale maintenance, regrading, and vegetation establishment. Flow can be bypassed by installing a pipe parallel to the swale and a flow regulating device inside the inlet structure. High flow bypasses may be of two types: "first-flush" treatment or design flow treatment. The "first-flush" treatment is based on the principal that storm event pollutants are more concentrated during the "first-flush." Biofiltration swales can be designed for treating stormwater only from this initial portion of the storm event, and would require bypassing stormwater flow around the swale during higher portions of flow. More typically, swale bypasses are designed to treat the design flow throughout the storm event, bypassing only the flows in excess of the design flow.

Riprap

Riprap is used as an energy dissipation or erosion control device in grassy swales. Riprap pads, consisting of 152 to 228 mm (6 to 9 in.) rocks fit tightly across the bed are used as an energy dissipater at the swale inlet, and continuing for a distance of 1.5 to 3 m (5 to 10 ft) downstream. Riprap can also be used to line the swale channel if erosion and/or channelization of the swale bottom are of concern. Riprap is also used with check dams as described above.

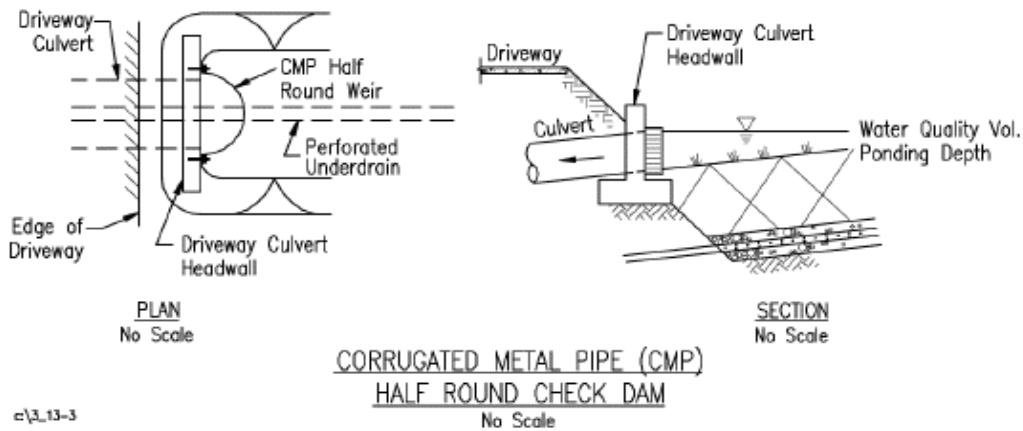
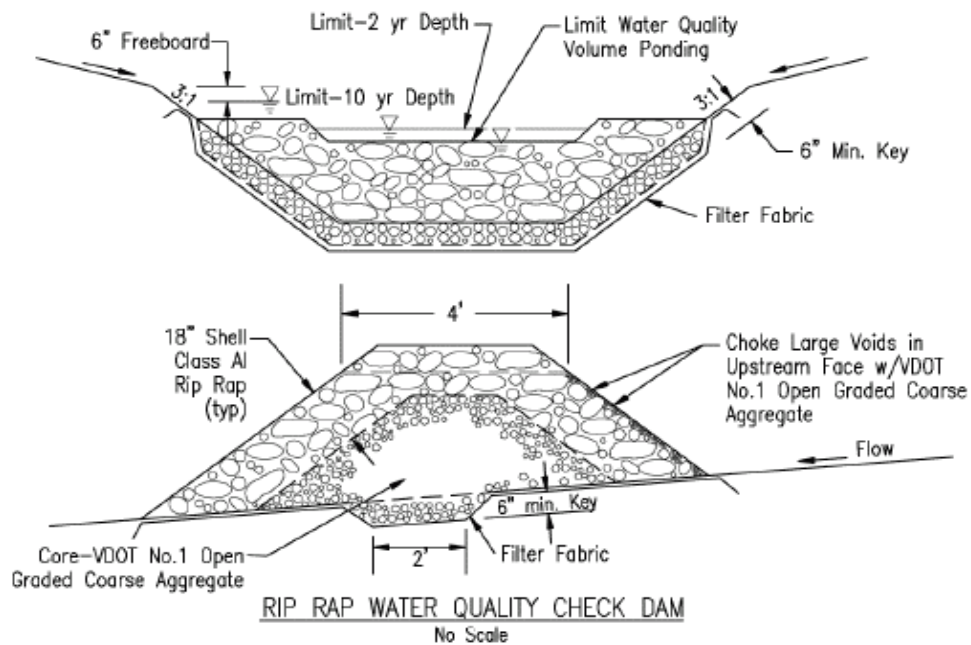

c\3.13-3

Figure 6-8 Typical Check Dam Configurations (VA DEC, 1999)

BMP Combinations

BMP combinations can be used with grassy swales. A frequently used combination is a swale with a check dam and an infiltration trench. The trench should be constructed under the swale. The pool created by the check dam increases the volume of surface runoff infiltrating into the trench.

Maintenance

Maintenance for grassed swales is minimal, and is largely aimed at keeping the grass cover dense and vigorous. Maintenance practices and schedules should be developed and included as part of the original plans to alleviate maintenance problems in the future. Recommended practices include 1) seasonal mowing and lawn care, 2) inspection, 3) debris and litter removal, 4) sediment removal and 5) grass re-seeding and mulching.

Seasonal Mowing and Lawn Care

Lawn mowing should be performed routinely, as needed, throughout the growing season. Grass height should be maintained at 5 mm (2 in.) above the design depth. Grass cuttings should be collected and disposed offsite, or a mulching mower can be used. Regular mowing should also include weed control practices, however herbicide use should be kept to a minimum (UDFCD, 1999). Healthy grass can be maintained without using fertilizers because runoff usually contains sufficient nutrients. Watering may be necessary, particularly in the first few months after establishment, or during times of drought (Driscoll and Mangarella, 1990). If nutrient control is an objective, mowing should be performed at the end of the growing season before grass goes dormant to avoid remobilization of nutrients held by vegetation (Khan, 1993).

Inspection

An annual inspection is suggested. However, additional inspection after periods of heavy runoff is most desirable. The swale should be checked for uniformity of grass cover, debris and litter, and areas of sediment accumulation (Driscoll and Mangarella, 1990). More frequent inspections of the grass cover during the first few years after establishment will help to determine if any problems are developing, and to plan for long-term restorative maintenance needs.

Debris and Litter Removal

Trash tends to accumulate in swale areas, particularly along highways. Any swale structures (i.e., check dams) should be kept free of obstruction to reduce floatables being flushed downstream and for aesthetic reasons. The need for this practice is determined through periodic inspection, but should be performed no less than twice per year.

Sediment Removal

Sediments accumulating near culverts and in channels needs to be removed when they build up to 100 mm (4 in.) at any spot, or cover vegetation. Excess sediment should be removed by hand or with flat-bottomed shovels. If areas are eroded, they should be filled, compacted, and re-seeded so that the final grade is level with the bottom of the swale (Khan, 1993). Sediment removal should be performed periodically, as determined through inspection. Estimate the need to remove sediment from 3 to 10% of the total length per year (UDFCD, 1999). Depending on the type of pollutants accumulated, some sediments may be considered hazardous waste or toxic material, and are therefore subject to restrictions for disposal in landfills. If this is a possible concern, State or local agencies can assist in obtaining testing requirements, and pollutant concentration standards.

Grass Re-seeding and Mulching

A healthy dense grass should be maintained in the channel and side slopes. Grass damaged during the sediment removal process should be promptly replaced using the same seed mix used during swale establishment. If possible, flow should be diverted from the damaged areas until the grass is firmly established (Khan, 1993). This practice is performed as needed based on annual inspection (UDFCD, 1999).

Private homeowners are often responsible for roadside swale maintenance. Unfortunately, overzealous lawn care on the part of homeowners can present some problems. For example, mowing the swale too close to the ground, or excessive application of fertilizer and pesticides are detrimental to the performance of the swale (Driscoll and Mangarella, 1992). Pet waste can also be a problem in swales, and should be removed to avoid contamination from fecal coliforms and other waste-associated bacteria. The delegation of maintenance responsibilities to individual land owners is a cost benefit to the locality. However, localities should provide an active educational program to encourage the recommended practices (Northern Virginia Planning District Commission and Engineers Surveyors Institute, 1992).

Cost Considerations

Typically, grassed swales cost less to construct than curb and gutters, and underground pipe. Costs for developing the vegetative cover are most variable, depending on the type of grass species chosen, and the method by which they are applied. Structural enhancements will also add to the cost. Costs may run from \$16 to \$49 per linear meter (\$5 to \$15

per linear foot), depending on local conditions, swale dimensions and the degree of internal storage provided (i.e., check dams) (DC, 2002). Swale design is relatively standard, and usually no special permitting costs are incurred. Regular maintenance costs for conventional swales are minimal (Schueler et al., 1992).

Section Seven Bioretention

Introduction

The bioretention concept was originally developed for the Prince George's County, Maryland, Department of Environmental Resources in the early 1990's as an alternative to traditional BMP structures (Clar et al., 1993). Bioretention is a practice to manage and treat stormwater runoff using a conditioned planting soil bed and planting materials to filter runoff stored within a shallow depression. The system consists of a flow regulation structure, a pretreatment filter strip or grass channel, a sand bed, pea gravel overflow curtain drain, a shallow ponding area, a surface organic layer of mulch, a planting soil bed, plant material, a gravel under drain system, and an overflow system (Figure 2-5). This BMP incorporates most of the available pollutant removal processes including settling within the shallow ponding area, physical filtering through the several layers of the filter, adsorption and cation exchange with biologically active organic materials in the filter, and phytoremediation by the plant materials in the filter.

Bioretention is a very versatile, highly flexible, multi-functional, micro-scale BMP. Also referred to as a “raingarden,” it can easily be incorporated into the landscape to address and maintain any or all of the essential hydrologic functions including: canopy interception, evapotranspiration, groundwater recharge, water quality control, runoff volume and peak discharge control. Because of its multi-functional and micro-scale characteristics, bioretention is one of the important BMP tools for the application of the LID technology for controlling runoff volume and pollutants (EPA, 2000a and b).

The drainage area to an individual cell should be kept very small, typically an acre or less. This encourages the use of a distributed micro-scale approach to SWM that first reduces the extent of hydrologic alterations for a given site, and secondly makes the management of the remaining impacts easier, more effective and less costly.

Alternative Applications

Bioretention can be applied to both new and existing development conditions, especially urban conditions (where pervious surfaces are likely to be limited to 10 to 20 % or less) (Clar, 2001).

Figure 7-1 provides schematic illustrations of a range of applications. The concept is applicable for residential land uses, either on private lots (Figure 7-2), or within common open space, and is certainly applicable for treating parking lot runoff for new development as shown in Figure 7-3, or to retrofit existing parking lots as shown in Figure 7-4. Bioretention is currently being integrated into the landscaping of institutional facilities (schools, libraries and other public buildings), as well as industrial and commercial sites. The practice is also applicable for roadways, where adequate space is available within the right of way, as shown in Figure 7-5. Bioretention facilities are also good candidates for pervious surface treatment, such as golf courses and parks.

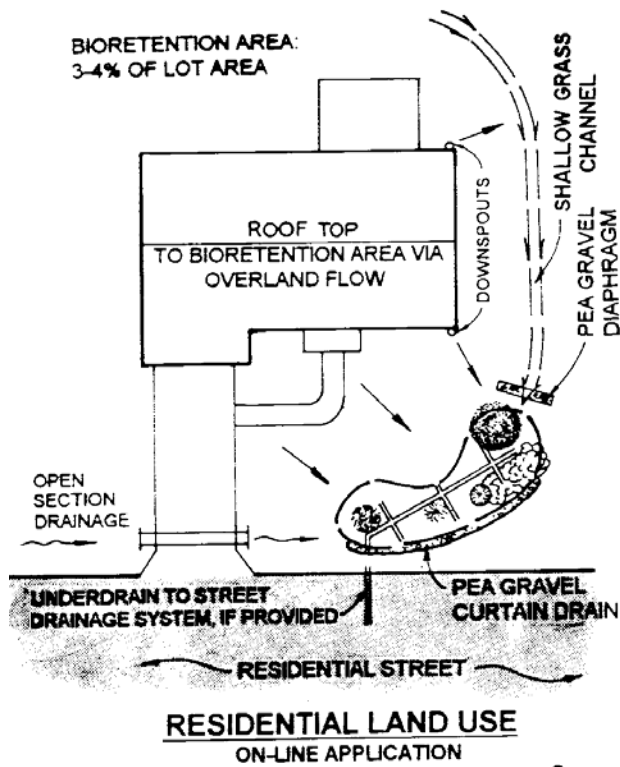

a

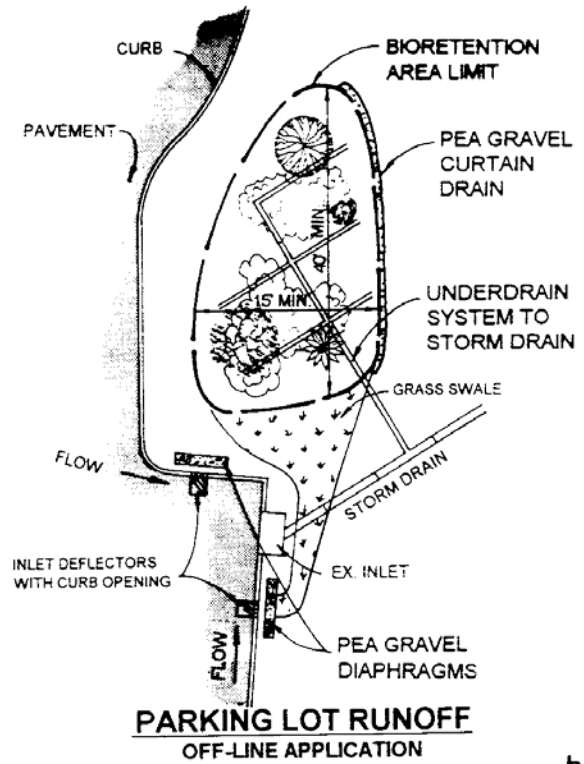

b

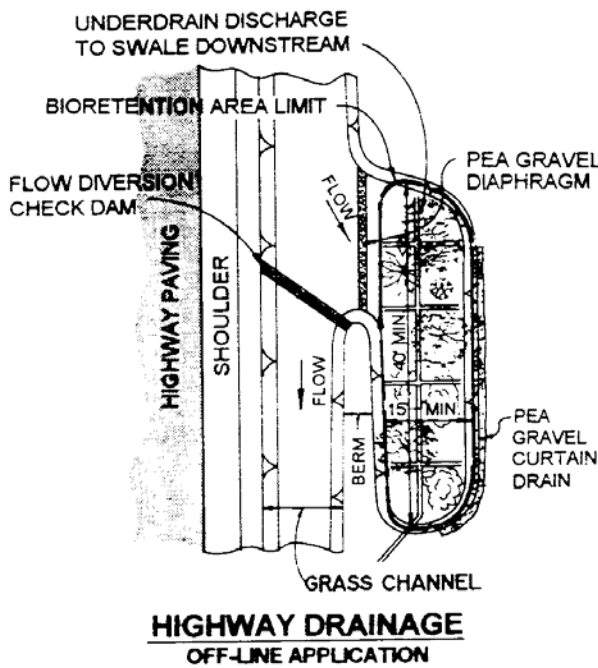

c

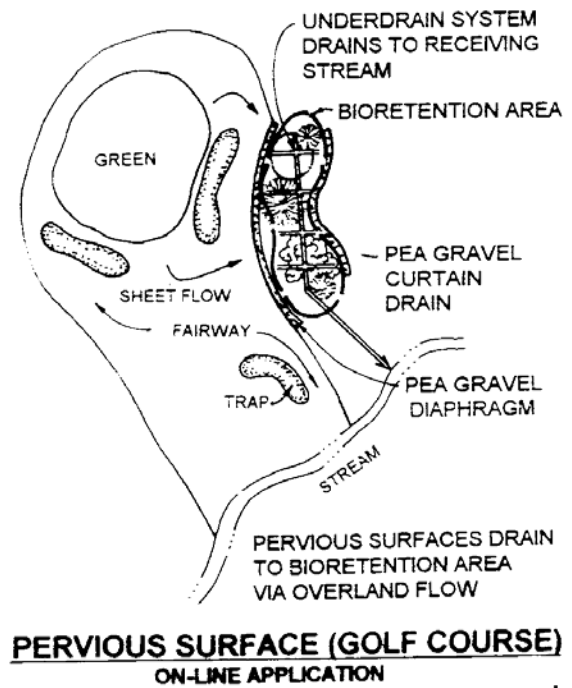

d

Figure 7-1 Typical Applications of Bioretention Systems (Clar and Green, 1993 and CRC, 1996 used with permission)



Figure 7-2 Bioretention Application on a Single Family Lot

Pollutant Removal

Not surprisingly, since this is a relatively new BMP, the available data on the pollutant removal performance of bioretention cells is still relatively scarce. The preliminary reports from field monitoring activities such as those conducted at the Beltway Plaza location in Prince George’s County, Maryland (Figure 7-3) summarized in Table 7-1, are verifying that this BMP not only met local water quality control criteria, but actually ranked as one of the most effective pollutant removal BMPs available. In addition, the initial success of this site suggested that bioretention could be an effective retrofit BMP for existing urban areas.

Table 7-1 Pollutant Removal Performance of Bioretention Practices (% Removal Rates) (Davis et al., 1998)

	Cu	Pb	Zn	P	TKN	NH₄	NO₃	TN
Upper Zone	90	93	87	0	37	54	-97	-29
Middle Zone	93	99	98	73	60	86	-194	0
Lower Zone	93	99	99	81	68	79	23	43



Figure 7-3 Bioretention Application on New Parking Lot



Figure 7-4 Bioretention Application to Retrofit an Existing Parking Lot



Figure 7-5 Bioretention Application in a Roadway Median

The University of Virginia, Charlottesville, VA initiated a long term study of on the performance of bioretention. This study differs from the bioretention study conducted in Maryland that monitored a single storm event (3 in. of rainfall). The University of Virginia study (Yu et al., 1999) provided performance data based on an annual hydrologic budget analysis. Initial, first year results indicate that the performance of the bioretention cells will exceed expectations, with results as follows: 86% for TSS, 90% for TP, 97% for COD, and 67% for oil and grease.

System Components

The bioretention cell incorporates the following components:

1. flow regulation and/or intake
2. pretreatment
3. shallow ponding area
4. surface mulch (organic) layer
5. planting soil bed
6. plant material
7. sand bed (optional)
8. gravel under drain system
9. overflow system.

Each component of the bioretention system is integral to the long term success of the practice and must be evaluated carefully in the overall design.

Flow Regulation and/or Intake

The intake structure is equally important for both offline and on-line applications to insure non-erosive velocities with adequate protection against clogging. For off-line applications, this element is responsible for ensuring that the design volume, i.e., groundwater recharge, water quality and peak discharge control, is captured and diverted to the practice for treatment.

Pretreatment

This component is optional, but is highly recommended where the site has sufficient space. Pretreatment reduces incoming velocities and captures coarser sediment particles which extends the design life and reduce replacement maintenance of the bioretention system. The pretreatment method may include a VFS or incorporate other techniques, such as a sand or gravel diaphragm to aid in extending the design life of the practice.

Shallow Ponding Area

The shallow ponding area just above the mulch layer and vegetation root zone provides surface storage for the design volume. This area also allows for particulate settling during the detention period allowing finer particles to settle on the surface of the mulch layer.

Surface Mulch Layer

The mulch layer provides an environment for plant growth by maintaining moisture and allowing for the decomposition of organic matter. The surface layer acts as a filter for finer particles still in suspension and maintains an environment for the microbial community to help breakdown urban runoff pollutants. Recent monitoring data indicates that the mulch layer is very effective in trapping and mobilizing metals (Davis et al., 1998).

Planting Soil Bed

The planting soil bed provides the region for water and nutrients for the planting material above. The voids within the soil provide additional storage for the runoff volume. The soil particles filter and trap pollutants, and can also adsorb various pollutants through cation exchange.

Planting Material

The plant material takes up some nutrients and other pollutants through the phytoremediation process, and available water through evapotranspiration. The use of native plant material, combined with a minimum planting area size, provides cover for wildlife and creates a micro environment within the urban landscape.

Sand Bed

The sand bed is optional, but is recommended to keep finer soil particles from washing out through the under drain system, and it provides an aerobic sand filter as a final “polishing” treatment media. A nominal thickness of 1 ft is suggested.

Gravel Under Drain System

This component is utilized to collect and distribute treated excess runoff. A properly designed under drain system helps keep the soil from becoming saturated. The under drain system consists of a gravel layer with a 4 or 6 in. perforated piping system (maintaining a 2 in. cover of gravel over the pipe). The under drain system can be either connected to an overflow system, such as a storm drain inlet, or it can be day lighted.

Overflow System

The overflow system provides a means to convey larger storm flow volumes to the downstream receiving waters or drainage system. This component usually consists of a conventional drainage catchbasin, inlet, or overflow channel located slightly above the shallow ponding limit.

Flow Regulation

The basic flow regulation design objective is to capture and/or divert the design volume or storm to the bioretention area. The larger storms can be designed to either flow through or “bypass” to the downstream storm drainage system, detention pond or receiving water. In some cases, utilizing bioretention structures for treating the design volume or storm throughout a site or subcatchment may also provide significant runoff attenuation to effectively manage smaller “quantity control” storms as well. Therefore, the need for downstream detention facilities may be reduced and/or eliminated. The LID approach to stormwater management design recognizes and builds upon this concept (PGC, 1997 and EPA, 2000a and b).

Street or Parking Lot Runoff

Runoff from curbed pavements can be diverted using a curb opening (Clar and Green, 1993) combined with a 6 in. drop below the curb, with a pea gravel diaphragm, as illustrated in Figure 7-6. For steeper slopes a curb opening with slotted deflector grooves in the gutter pan can be used to improve runoff capture, as shown in Figure 7-7 (Clar and Green, 1993).

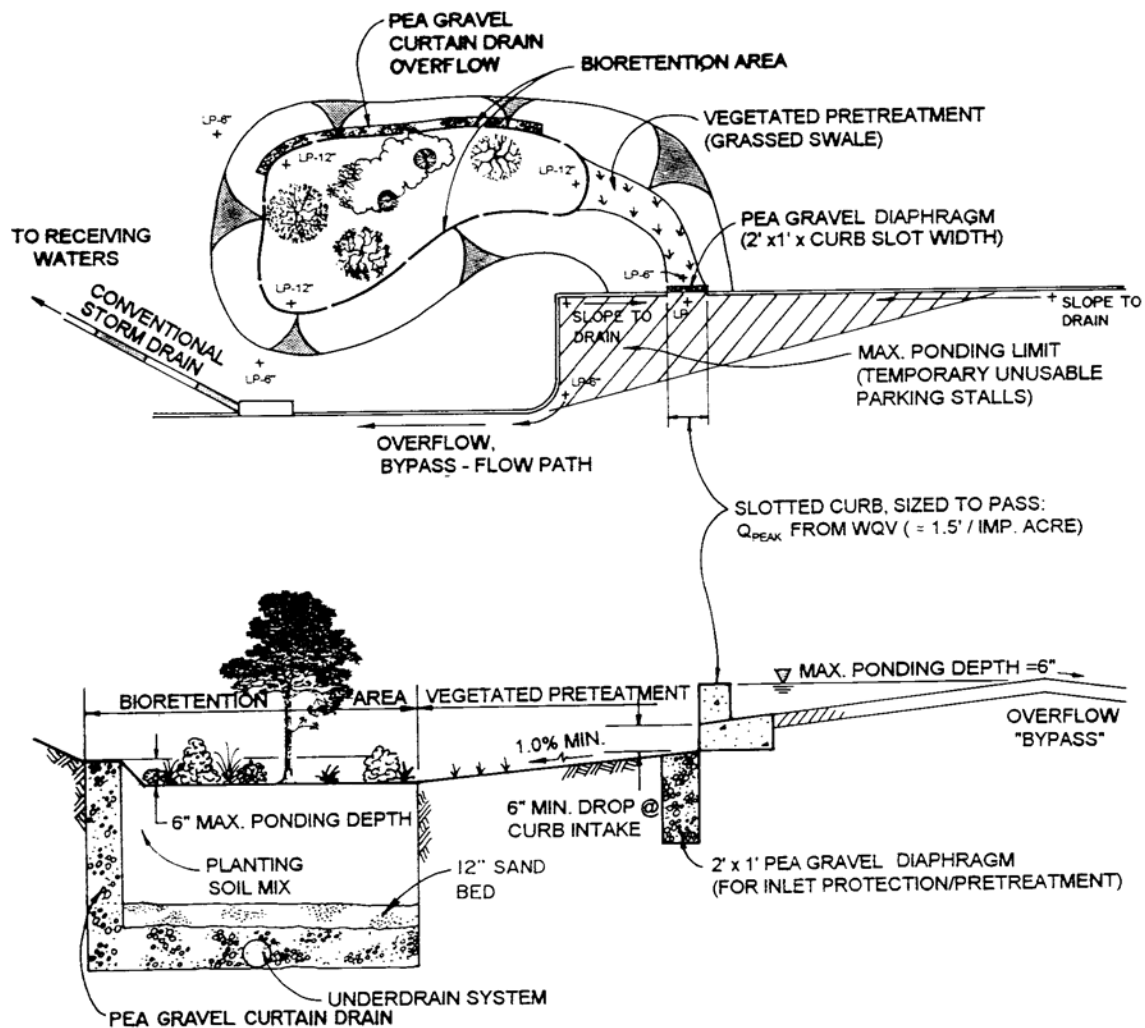

Figure 7-6 Bioretention Area with Slotted Curb Flow Diversion System (Clar and Green, 1993 and CRC, 1996 used with permission)

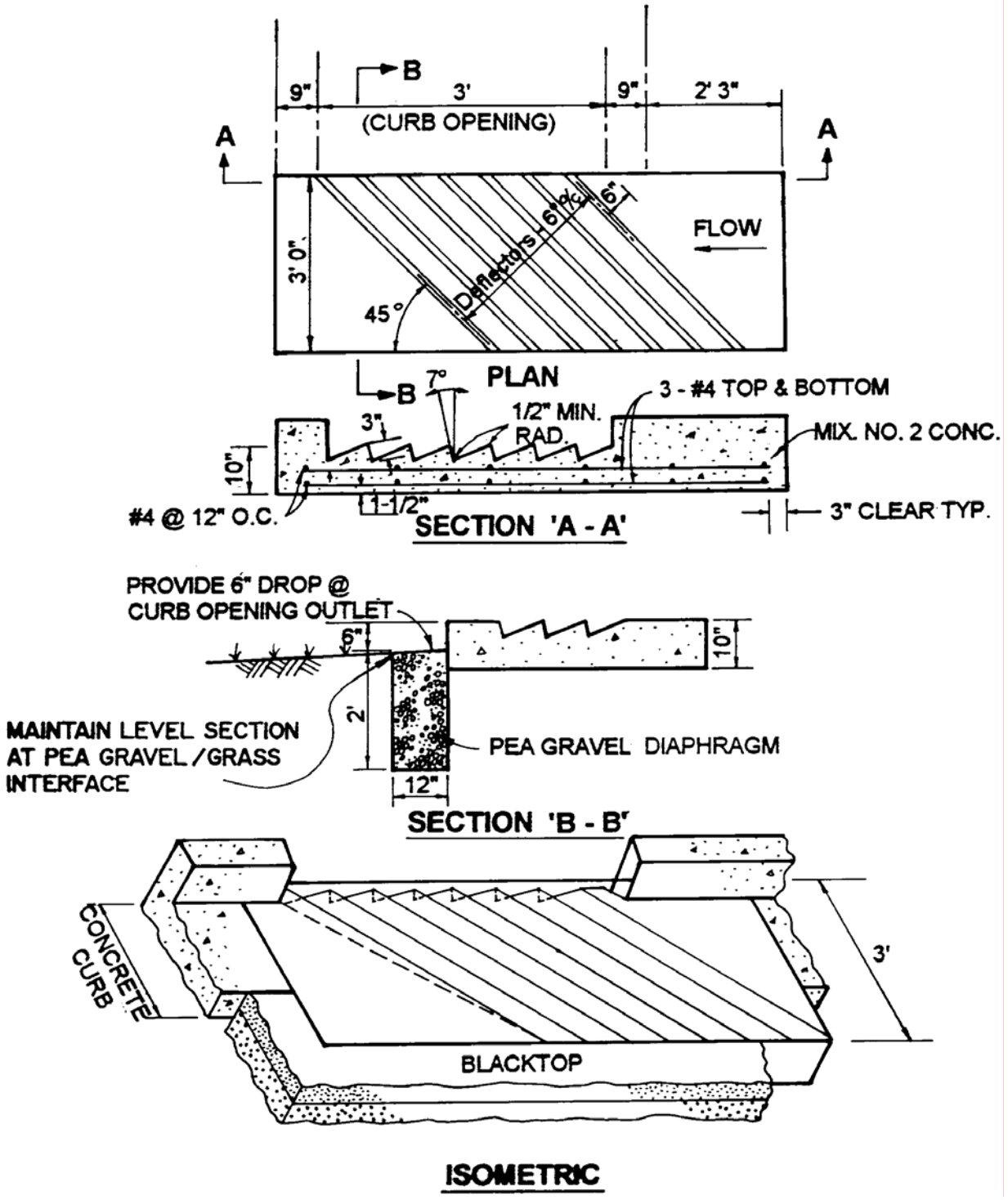

Figure 7-7 Inlet Deflector Detail (Clar and Green, 1993 and CRC, 1996 used with permission)

Channel Flow

Runoff from open conveyance channels can be diverted into bioretention area. A log, concrete curb stop or other structural measure in the form of a check dam, backs-up flowing water to a 6 to 9 in. maximum depth which then flows into the adjacent bioretention area. Once the ponded water reaches the design capacity, the water overflows the checkdam and proceeds downstream (See Figure 7-1c for application of this technique).

Pretreatment

Pretreatment for bioretention areas is an optional design feature. The original design guidance (Clar and Green, 1993) specified the use of a filter strip for pretreatment. However design and operational experience has demonstrated that pretreatment is not essential to the proper functioning of these BMPs. Space constraints in the design of bioretention systems as parking lot islands eliminated the use of the pretreatment filter strip. Operational experience and observation has revealed that with minimal maintenance these systems function well without the pretreatment. The drainage area to the bioretention systems is severely limited. It is recommended that drainage area be kept under 1 acre of impervious surface for optimum performance. This allows the bioretention systems to be designed as an on-line system without raising undue concern for the impacts associated with larger storms, including erosion problems at the inflow points, disruption of the mulch layer, and otherwise negatively affecting the plant material. It is recommended to design these systems on-line, preferably, immediately above the first storm drain inlet. The designs should incorporate adequate overflow measures to accommodate larger flows. A yard inlet storm drainage structure, with the throat opening held 6 to 9 in. above the top of the mulch layer is one technique for handling overflow. This approach has many benefits that include increased groundwater recharge, reduction in curve number (**CN**) value, reduction in the runoff volume, increase in the time of concentration and corresponding decrease in the peak discharge value.

The pea gravel diaphragm is designed to slow the velocity and aid in spreading out the flow entering the practice. In addition, this component captures the coarser-grained sediments. It is anticipated that the pea gravel diaphragm will exhibit clogging within the first three to four years after installation and may require periodic flushing and/or replacement. If pretreatment is used the maintenance schedule of the facility should reflect this requirement.

Shallow Ponding Area

Bioretention facilities can be sized to handle a specified volume as either a filtering or an infiltrating bed. Guidance for these two approaches is provided below, after the minimum sizing guidance.

Minimum Sizing Guidance

In order to maintain a suitable micro-environment and to help simulate conditions which exist within an existing forest community, bioretention facilities are recommended to provide a minimum area coverage. The sizing criteria presented above ensures the necessary treatment area and volume to accommodate the V_{wQ} , but additional criteria (Table 7.2) were developed for Prince George's County, MD to assure the survival and success of the planted material.

The minimum width allows for random spacing of trees and shrubs, it also permits planting densities which help create a micro-environment where stresses from urban stormwater pollutants are minimized. The maximum ponding depth of 6 to 12 in. provides surface storage for stormwater runoff (approximately 40% of V_{wQ}) but is not so deep as to adversely affect plant health. The shallow depth also will dissipate within a reasonable time (less than 2 days) which maintains flexibility in species selection, and minimizes the likelihood that the bioretention area will become a breeding ground for mosquitoes. The 2 to 4 ft planting soil bed depth is sized to provide adequate storage for the design volume, suitable capacity for root system growth and adequate moisture in the soil during dryer periods (Clar and Green, 1993).

Table 7-2 Recommended Sizing Guidance for Bioretention Facilities (Adapted from Clar and Green, 1993)

Dimension	Size Range (ft)
Minimum width	6 - 10
Minimum length	10 - 15
Maximum shallow ponding dept	0.5 - 1
Minimum planting soil bed depth (optional sand bed)	2 - 4 (1)

Filter Bed Design

The filter bed design is based on the use of Darcy's Law as derived by the City of Austin TX (City of Austin, TX, 1988). Since the bioretention concept incorporates a gravel under drain system and a porous soil filter medium and sand bed, runoff entering the shallow ponding area will slowly percolate through the soil bed in a fashion similar to other filter practices.

Equation 7-1 is utilized to estimate the minimum surface area and then the volume capacity is checked against that design volume capacity. When used as a filter, only the water quality volume (V_{WQ}) is used for design purposes.

$$A_f = V_{WQ} \frac{(d_b)}{k} (h + d_b) (t_f) \tag{7-1}$$

where: A_f = surface area of the bioretention planting bed (ft²),
 V_{WQ} = water quality treatment volume (ft³),
 d_b = planting soil-bed depth (ft),
 k = coefficient of permeability for planting soil bed (ft/day),
 h = average height of water above the bioretention bed (ft) with average $h = \frac{1}{2}$ maximum h , and
 t_f = time required for the water quality treatment volume (V_{WQ}) to filter through the planting soil bed.

The following design notes apply to this approach:

1. V_{WQ} is computed using the Short Cut method described in the AppendixB of Volume 1
2. $d_b = 4$ ft
3. $k = 0.5$ ft/day
4. h is equal to 3 in., assuming a maximum ponding depth of 6 in. above the planting soil bed
5. a value of 72 hr is recommended for the filter drawdown time (t_f).

The following equation can be used for sizing the bioretention surface area:

$$A_f = A_d \times 5.0\% \times R_v \tag{7-2}$$

where: A_f = the required surface area of the bioretention facility, and
 A_d = the drainage area.

The volumetric runoff coefficient, R_v , is computed using the Short Cut method.

The sizing criteria for a bioretention facility (Clar and Green, 1993; modified by CRC, 1996) based on a 1 acre site that is 100% impervious ($R_v = 0.95$) is as follows:

$$\begin{aligned}
 V_{wQ} &= [1.0 \text{ in.}(0.95)/12 \text{ in/ft}] \times (43,560 \text{ ft}^3/\text{acre}) = 3,449 \text{ ft}^3 \\
 k &= 1.0 \text{ ft/day} \\
 d_f &= 4 \text{ ft} = (3 \text{ ft soil and 1ft sand bed}) \\
 h &= 3 \text{ in.} = 0.25 \text{ ft} \\
 t_f &= 3 \text{ days} \\
 A_f &= (3,449\text{ft}^3)(5\text{ft}) / [(0.5 \text{ ft/day})(4.25\text{ft})(3 \text{ days})] = 2,164 \text{ ft}^2 \\
 \% \text{ of site area} &= 2,164 \text{ ft}^2 / 43,560 \times 100 = 5.0.
 \end{aligned}$$

Infiltration Bed Design

There are two general types of situations where bioretention cells can be designed as an infiltration practice. First, one may be interested in the dimensions of a bioretention cell that is required to provide storage of the design storm volume for groundwater recharge (Re_v), water quality control (V_{wQ}), or peak discharge control (q_p). Second, site conditions may dictate the layout and capacity of the bioretention cell, and one might be interested in determining the level of control provided by such a layout. In the latter case, control may not be sufficient, and additional control, possibly using other acceptable BMPs, may be required. It is important to emphasize that the same principles of design apply to both cases.

The design procedure for an infiltration trench can be used to size a bioretention cell that is designed for infiltration. The design procedure of an infiltration trench is based on the textural class of the soils underlying the trench or bioretention cell, such that a feasible design is possible. The design of an infiltration trench is also based on the maximum allowable depth of the trench (d_{max}). The maximum allowable depth should meet the following criteria:

$$d_{max} = fT_s / n \tag{7-3}$$

where: f = the final infiltration rate of the cell area in in/hr,
 T_s = the maximum allowable storage time in hr, and
 n = the porosity (V_v/V_t) of the soil media reservoir.

A bioretention cell can be sized to accept the design volume that enters the cell (V_w) plus the volume of rain that falls on the surface of the cell (PA_t) minus the exfiltration volume(fTA_t) out of the bottom of the cell. Based on the NRCS hydrograph analysis, the effective filling time for most infiltration trenches (T) will generally be less than 2 hr. The volume of water that must be stored in the cell (V) is defined as:

$$V = V_w + PA_t - fTA_t \tag{7-4}$$

where: P = the design rainfall event (ft), and
 A_t = the cell surface area (ft²).

For most design storm events, the volume of water due to rainfall on the surface area of the cell (PA_t) is small when compared to the design volume (V_w) of the cell and may be ignored with little loss in accuracy to the final design. The volume of rainfall and runoff entering the trench can be defined in terms of trench geometry. The gross volume of the trench (V_t) is equal to the ratio of the volume of water that must be stored (V) to the porosity (n) of the stone reservoir in the trench; V_t is also equal to the product of the depth (d_t) and the surface area (A_t) as follows:

$$V_t = V / n = d_t A_t n \tag{7-5}$$

Combining equations 7-4 and 7-5 yields the following relationship:

$$d_t A_t n V_w = f T A_s \quad (7-6)$$

Because both dimensions of the trench are unknown, this equation may be rearranged to determine the area of the trench (A_t) if the value of d_t were set based on either the location of the water table or the maximum allowable depth of the trench (d_{max}):

$$A_t = V_w / (n d_t + f T) \quad (7-7)$$

Surface Mulch Layer

The mulch layer plays an important role in the performance of the bioretention system. The mulch layer helps maintain soil moisture and avoids surface sealing which reduces permeability. Mulch helps prevent erosion, and provides a micro environment suitable for soil biota at the mulch/soil interface. It also serves as a pretreatment layer, trapping the finer sediments which remain suspended after the primary pretreatment.

Mulch should be placed to a uniform thickness of 2 to 3 in. Shredded hardwood mulch is the only accepted mulch. Pine mulch and wood chips will float and move to the perimeter of the bioretention area during a storm event. The mulch layer should be uniform in color, and free of other materials, such as weed seeds, soil, roots, etc. Fresh grass clippings should not be used as a mulch, or added to mulch material. Shredded mulch must be well aged (6 to 12 months) for acceptance.

Planting Soil Bed Characteristics

The characteristics of the soil for the bioretention facility are perhaps as important as the facility location, size, and treatment volume. The soil must be permeable enough to allow runoff to filter through the media, while having characteristics suitable to promote and sustain a robust vegetative cover crop. In addition, much of the nutrient pollutant uptake (nitrogen and phosphorus) is accomplished through adsorption and microbial activity within the soil profile. Therefore, the soils must balance soil chemistry and physical properties to support biotic communities above and below ground.

The planting soil should be a sandy loam or loamy sand (USDA), or a loam/sand mix (should contain a minimum 50 to 70% sand, by volume). The clay content for these soils should be less than 10% by volume. Soils should fall within the SM, ML, SC classifications or the Unified Soil Classification System (USCS). A permeability of at least 1.0 ft/d (0.5 in/hr) is required (a conservative value of 0.5 ft/d is used for design). The soil should be free of stones, stumps, roots, or other woody material over 1 in. in diameter. Brush or seeds from noxious weeds (e.g., Johnson Grass, Mugwort, Nutsedge, and Canada Thistle or other noxious weeds as specified under COMAR 15.08.01.05.) should not be present in the soils. The specific characteristics are presented in Table 7-3.

It is very important to minimize compaction of both the base of the bioretention area and the required backfill. When possible, use excavation hoes to remove original soil. If bioretention areas are excavated using a loader, the contractor should use wide track or marsh track equipment, or light equipment with turf type tires. Use of equipment with narrow tracks or narrow tires, rubber tires with large lugs, or high pressure tires will cause excessive compaction resulting in reduced infiltration rates, and therefore, is not acceptable. Compaction will significantly contribute to design failure.

Table 7-3 Planting Soil Characteristics (Clar et al., 1993)

Parameter	Value
pH Range	5.2 - 7.0
Organic Matter	20 - 50%
Magnesium	35 lb / acre, minimum
Phosphorous	75 lb / acre, minimum
Potassium	85 lb / acre, minimum
Soluble Salts	<500 ppm
Silt/Clay	<10%
Sand	50-70%

Compaction can be alleviated at the base of the bioretention facility by using a primary tilling operation such as a chisel plow, ripper, or subsoiler. These tilling operations are to refracture the soil profile through the 12 in. compaction zone. Substitute methods must be approved by the engineer. Rototillers typically do not till deep enough to reduce the effects of compaction from heavy equipment. Rototill 2 to 3 in. of sand into the base of the bioretention facility before backfilling the required sand layer. Pump any ponded water before preparing (rototilling) base. When backfilling the topsoil over the sand layer, first place 3 to 4 in. of topsoil over the sand, then rototill the sand/topsoil to create a gradation zone. Backfill the remainder of the topsoil to final grade.

When backfilling the bioretention facility, place soil in lifts 12 to 18 in.. Placement of the planting soil should be in lifts of 12 to 18 in., loosely compacted (tamped lightly with a dozer or backhoe bucket).

Soil Amendments

The performance of the bioretention system can be greatly improved by adding organic materials such as leaf compost or peat moss to the soil mix. These materials can be mixed into the soil materials in proportions ranging from at least 20% to a maximum of 50%. The addition of these amendments improve the permeability of the soil mix and also enhance the removal of pollutants through cation exchange and adsorption processes. Ongoing research into the improvement of design methods and models for bioretention is evaluating the benefits of multi layered bioretention design concepts (Vogel et al., 2001). A typical soil mix recommendation that incorporates these soil amendments:

- 30% by volume of leaf compost
- 70% by volume of sand with only 5 % of clay/silt mix
- the proportion by volume of sand and leaf composting shall be in a ration of 3:1
- soil mixture shall have a pH indicator of 6.0 to 6.5.

Planting Material

Plant material selection should be based on the goal of simulating a terrestrial forested community of native species. Bioretention simulates an ecosystem consisting of an upland-oriented community dominated by trees, but having a distinct community or sub-canopy of under story trees, shrubs and herbaceous materials. The intent is to establish a diverse, dense plant cover to treat stormwater runoff, and withstand urban stresses from insect and disease infestations, drought, temperature, wind, and exposure.

The proper selection and installation of plant materials is key to a successful system. There are essentially three zones within a bioretention facility (Figure 7-8). The lowest elevation supports plant species adapted to standing and fluctuating water levels. The middle elevation supports a slightly drier group of plants, but still tolerates fluctuating water levels. The outer edge is the highest elevation and generally supports plants adapted to dryer conditions.

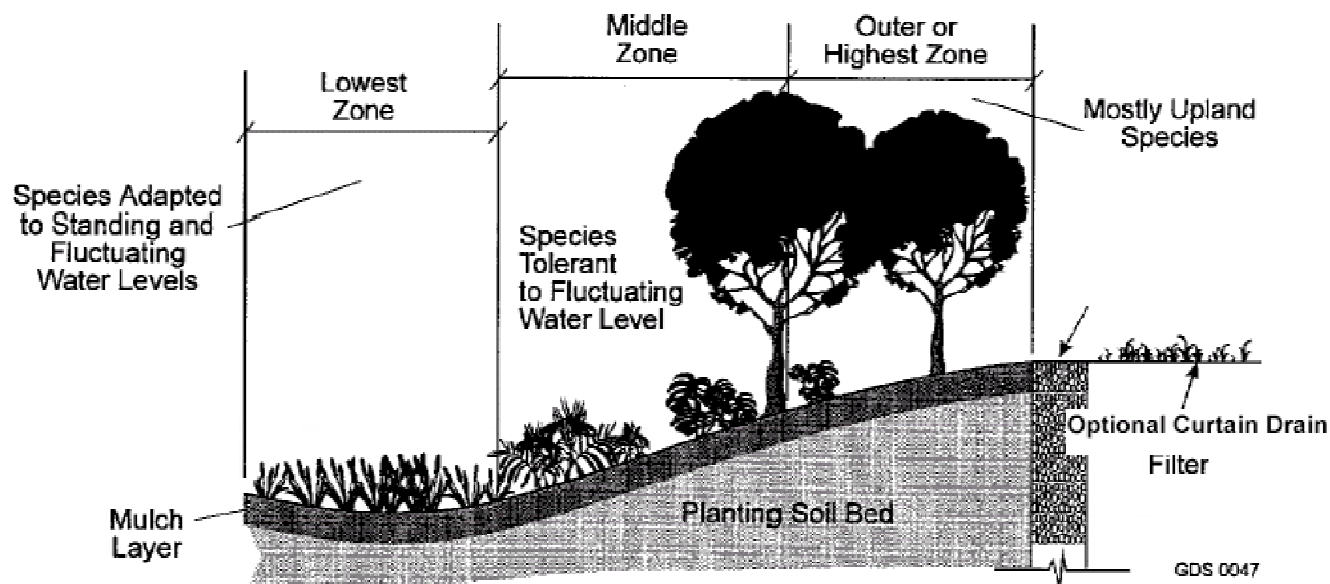

Figure 7-8 Planting Zones for Bioretention Facilities (MDE, 2000)

Appropriate plant materials for bioretention facilities for the Mid Atlantic Region are presented in are included in Table 7-4. This list was adapted from the work by Prince George's County, Department of Environmental Resources (Clar and Green, 1993). For other areas of the country, designers should refer to their local landscape and plant materials specifications.

The layout of plant material should be flexible, but should follow the general principals described in Table 7-5. The objective is to have a system which resembles a random and natural plant layout, while maintaining optimal conditions for plant establishment and growth.

Plant materials should conform to the American Standard Nursery Stock, published by the American Association of Nurserymen, and should be selected from certified, reputable nurseries. Planting specifications should be prepared by the designer and should include a sequence of construction, a description of the contractor's responsibilities, a planting schedule and installation specifications, initial maintenance, and a warranty period and expectations of plant survival. Table 7-6 presents some typical issues for planting specifications.

Table 7-4 Commonly Used Species for Bioretention Areas (MDE, 2000)

Trees	Shrubs	Herbaceous Species
<i>Acer rubrum</i> Red Maple	<i>Aesculus parviflora</i> Bottlebrush Buckeye	<i>Andropogon virginicus</i> Broomsedge
<i>Betula nigra</i> River Birch	<i>Cephalanthus occidentalis</i> Buttonbush	<i>Eupatorium perpurea</i> Joe Pye Weed
<i>Juniperous virginiana</i> Eastern Red Cedar	<i>Hamamelis virginiana</i> Witch Hazel	<i>Scirpus pungens</i> Three Square Bulrush
<i>Chionaminus virginicus</i> Fringe-tree	<i>Vaccinium corymbosum</i> Highbush Blueberry	<i>Iris versicolor</i> Blue Flag
<i>Nyssa sylvatica</i> Black Gum	<i>Ilex glabra</i> Inkberry	<i>Lobelia cardinalis</i> Cardinal Flower
<i>Diospyros virginiana</i> Persimmon	<i>Ilex verticillata</i> Winterberry	<i>Panicum virgatum</i> Switchgrass
<i>Platanus occidentalis</i> Sycamore	<i>Viburnum dentatum</i> Arrowwood	<i>Dichanthelium scoparium</i> Broom Panic Grass
<i>Quercus palustris</i> Pin Oak	<i>Lindera benzoin</i> Spicebush	<i>Rudbeckia laciniata</i> Tall Coneflower
<i>Quercus phellos</i> Willow Oak	<i>Myrica pennsylvanica</i> Bayberry	<i>Scirpus cyperinus</i> Woolgrass
<i>Salix nigra</i> Black willow		<i>Vernonia noveboracensis</i> New York Ironweed

Table 7-5 Planting Plan Design Considerations (MDE, 2000)

- Native plant species should be specified, no exotic or foreign species
- Appropriate vegetation should be selected based on zone of hydric tolerance
- Species layout should generally be random and natural
- A canopy should be established with an underscore of shrubs and herbaceous materials
- Woody vegetation should not be specified in the vicinity of the inflow locations
- Trees should be planted primarily along the perimeter of the bioretention area
- Urban stressors (e.g. wind, sun, exposure, insect and disease infestation, drought) should be considered when laying out the planting plan
- Noxious weeds should not be specified
- Aesthetics and visual characteristics should be a prime consideration
- Traffic and safety issues must be considered
- Existing and proposed utilities must be identified and considered

Table 7-6 Planting Specification Issues (MDE, 2000)

Specification Element	Elements
Sequence of Construction	Describe site preparation activities, soil amendments, etc. Address erosion and sediment control procedures. Specify step-by-step procedure for plant installation through site clean up.
Contractor's Responsibilities	Specify the contractor's responsibilities, such as watering, care of plant material during transport, timeliness of installation, repairs due to vandalism, etc.
Planting Schedule and Specifications	Specify the plants to be installed, the type of materials (e.g., balled and burlap, bare root, containerized), time of year of installations; sequence of installation of types of plants, fertilization, stabilization seeding (if required), watering and general care.
Maintenance	Specify inspection periods, mulching frequency (annual mulching is most common), removal and replacement of dead and diseased vegetation, treatment of diseased trees, watering schedule after initial installation (once per day for 14 days is common), and repair and replacement of staking and wires
Warranty	Specify the warranty period, the required survival rate and expected condition of plant species at the end of the warranty period.

Plant Installation

Root stock of the plant material shall be kept moist during transport and on-site storage. The plant root ball should be planted so 1/8th of the ball is above final grade surface. The diameter of the planting pit shall be at least 6 in. larger than the diameter of the planting ball. Set and maintain the plant straight during the entire planting process. Thoroughly water ground bed cover after installation.

Trees shall be braced using 2 by 2 (in.) stakes only as necessary and for the first growing season only. Stakes are to be equally spaced on the outside of the tree ball.

Grasses and legume seed should be drilled into the soil to a depth of at least 1 in. Grass and legume plugs shall be planted following the non-grass ground cover planting specifications. The topsoil specifications provide enough organic material to adequately supply nutrients from natural cycling. The primary function of the bioretention structure is to improve water quality. Adding fertilizers defeats, or at a minimum, impedes this goal. Only add fertilizer if wood chips or mulch are used to amend the soil. Rototill urea fertilizer at a rate of 2 lb per 1000 ft².

Gravel Underdrains

Underdrains are to be placed on a 3 ft wide section of filter cloth. Pipe is placed next, followed by the gravel bedding. The ends of underdrain pipes not terminating in an observation well shall be capped.

The main collector pipe for underdrain systems shall be constructed at a minimum slope of 0.5%. Observation wells and/or clean-out pipes must be provided (one minimum per every 1000 ft² of surface area).

The under drain system design includes the following considerations:

- a perforated pipe (4 in. minimum) system within an 8 in. gravel bed
- the pipe should have 3/8 in. perforation, spaced at 6 in. centers, with a minimum of 4 holes per row
- the pipe should be spaced at a maximum of 10 ft on-center and a minimum grade of 0.5% should be maintained
- at least one clean out per run should be provided.
- the under drain system should be connected to the conventional drainage system, or should daylight to a suitable, non-erosive outfall.

Overflow System

The overflow component of the bioretention system consists of the gravel under drain system, as specified above, and a high flow overflow structure.

The high flow overflow system usually consists of a yard drain catch basin (see Figure 7-1), but any number of conventional drainage practices may be used, including an open vegetated or stabilized channel. The system should be designed to convey the design peak discharge, if the system is located offline, and should be set above the shallow pending limit if the facility is located on-line, the high flow overflow should be designed as a conventional storm drainage structure, or channel. The overflow system should be connected to the site drainage system, or should outfall to a suitable, non-erosive location.

Material and Other Bioretention Specifications

Table 7-7 and 7-8 identify many of the material specifications necessary for bioretention facilities. Designers should refer to their local landscape and plant materials specifications.

The bioretention facility may not be constructed until all contributing drainage area has been stabilized.

Table 7-7 Materials Specifications (MDE, 2000)

Parameter	Specification	Size	Notes
Planting Soil	Refer to Table 7-3	N/A	Refer to Table 7- 4 for suitable species
Mulch	Shredded hardwood mulch	uniform thickness of 2 to 3 in.	Aged 6 to12 months, minimum
Pea gravel diaphragm	ASTM D 448 size no.6	Varies (1/8 to 1/4 in.)	Use clean bank-run pea gravel
Under drain gravel	AASHTO M-43	½ to 2 in.	Use clean bank-run gravel
PVC Piping	AASHTO M-278	4 to 6 in. rigid schedule 40	3/8 in. perf. @ 6 in. centers, 4 holes per row

Table 7-8 Bioretention Planting Specifications (modified MDE 2000, adapted from Clar and Green, 1993)

Root stock of the plant material shall be kept moist during transport from the nursery.
Planting pits should follow local guidelines e.g. Landscape Contractors Association, MD - DC - VA (LCA) planting guidelines.
The diameter of the planting pit must be 6 in. larger than the diameter of the ball.
The planting pit should be deep enough to allow 1/8 in. of the ball to be above existing ground. Tamp loose soil at the bottom of the pit by hand.
Set and maintain the plant straight during the entire planting process.
Backfill the pit with existing soil.
Trees shall be braced using 2 by 2 (in.) stakes only as necessary and for the first growing season only. Stakes are to be equally spaced on the outside of the tree ball.
Planting non-grass ground cover:

- Dig holes through the mulch with hand trowel, shovel, bulb planter, or hoe.
- Split biodegradable pots and remove non-biodegradable pots.
- Surround the roots with soil below the mulch.
- Set potted plants so that the top of the pot is even with existing grade.
- Cover bare root plants to the crown
- Thoroughly water the entire ground cover bed.

Grasses and legumes seed shall be tilled into the soil to a depth of at least 1 in. Grass and legume plugs shall be planted following the non-grass ground cover planting specifications

Maintenance Guidelines

The following general maintenance guidance is recommended for bioretention systems. Although these systems are designed to simulate some of the functions of a natural forested plant community, the fact is, that these facilities are located within an urban setting and will be exposed to a wide array of conditions, many of which will tend to compromise the effectiveness of the system. Bioretention facilities will require a reasonable amount of routine maintenance (not too different from conventional landscaping maintenance) to ensure that the system both functions well as a stormwater BMP, and maintains an aesthetic element compatible with the surrounding land uses.

Inspections are an integral part of any maintenance program. Bioretention facilities should be inspected on a semi-annual basis for the first year, and after major storm events. After the first year annual inspections should be sufficient. Since the practice is relatively new, longer term maintenance issues may become apparent which are currently not well understood. There are, however, several maintenance objectives common to all filtering practices, plus some common sense issues specific to bioretention facilities. The following guidance is provided.

Mulch Layer

Bi-annual mulching, as part of a regular landscape contract, is recommended. The previous mulch may be removed and discarded to an appropriate disposal area or retained if it is decayed. Mulch depths should not exceed 3 in. Seeded ground cover or grass areas should not receive mulching.

Planting Soil Bed

The soils of the planting bed should be tested on an annual basis for pH to establish acidic levels. If the pH is below 5.2, limestone should be applied. If the pH is above 7.0 to 8.0 iron sulfate plus sulfur can be added to reduce the pH.

The soil bed may experience some erosion, particularly at the inflow points, periodic inspection and correction of erosion may be necessary. The surface of the bed may become clogged with fine sediments over time. Core aeration or cultivating of unvegetated areas may be required to ensure adequate filtration.

Planting Materials

Annual inspection of plant materials is necessary. Dead or severely diseased species should be replaced. Replacement of particular species should be considered for species which fail to establish.

Woody vegetation may require periodic pruning, depending on the adjacent land uses, to avoid conflicts with overhead utilities, or hazards with adjacent people and property. Pruning should follow the standard pruning practices (ANSI A300, National Arborist Association, Inc., 1995).

Remove plant stakes after the first growing season.

Pretreatment, Inflow Locations and Overflow

The pea gravel diaphragm should be inspected annually for clogging. Sediment build-up should be removed, as needed. Replacement of the diaphragm after three to four years may be warranted (or when the voids are obviously filled with sediment and water is no longer infiltrating).

The vegetated filter strip or grassed channel should be inspected for erosion rill or gulleys and corrected, as needed. Bare areas should be seeded, or sodded, as necessary.

The inflow location should be inspected annually for clogging. Sediment build-up is common problem with many practices where runoff leaves an impervious surface and enters a vegetative or earthen surface. Any built-up sediment should be removed to avoid runoff by-passing the facility.

The overflow structure should be inspected annually to ensure that it is functioning. Accumulated trash and debris should be removed as necessary.

Cost Considerations

Every site is unique, requiring specific cost estimating to account for the variability. In estimating the cost of using bioretention, a number of factors need to be considered that include:

- site restrictions- both physical and regulatory
- availability of materials, equipment and labor
- scheduling of tasks for efficiency.

There are also indirect cost benefits of utilizing bioretention that should be factored into the cost savings. These benefits include:

- the reduction or elimination of conventional stormwater management BMPs
- bonding and overall project cost reductions
- reduced stormwater conveyance costs
- reduced design costs with simplistic design
- reduced maintenance and liability costs
- aesthetic appeal not usually attributed to stormwater facilities
- multi functional landscaping.

A number of technical documents have attempted to define cost benefit ratios based on variables such as the contributing drainage area controlled, storage area provided or surface area required. The methodology typically employed attempts to derive cost formulas that a designer can use to quickly calculate stormwater costs for their project. This approach can provide insufficient criteria for BMP selection, however if the factors listed above are not included in the cost benefit analysis. A better approach is to analyze anticipated costs of project tasks and sub-tasks within project phases, might be to evaluate specific costs of material, equipment, and labor with respect to the project schedule.

Table 7-9 provides a range of typical costs associated with various applications of the bioretention BMP, including: 1) a homeowner installation of residential rain garden, 2) bioretention applications within a residential lot subdivision, 3)

bioretention application on a single lot basis, 4) a bioretention application on a commercial lot and 5) a bioretention retrofit on a commercial lot (Winogradoff, 2001). The costs are broken down by the various phases of the project schedule. The assumptions used in the cost estimate are detailed below.

Table 7-8 Typical Bioretention Costs (Winogradoff, 2001)

Task/Activity Description	Residential Rain Garden	Residential lot - Subdivision	Single Residential Lot	Commercial - New	Commercial - Retrofit
<i>Total Cost</i>	\$ 1075	\$ 3790	\$ 7775	\$ 10357	\$ 12355
<i>Planning Phase</i>	\$ 25	\$ 95	\$ 200	\$ 845	\$ 350
<i>Design Phase</i>	\$ 100	\$ 340	\$ 875	\$ 3600	\$ 2410
<i>Construction</i>	\$ 950	\$ 3225	\$ 5750	\$ 5237	\$ 7943
<i>Close Out</i>	NA	\$ 130	\$ 950	\$ 675	\$ 1652

Assumptions Used in Cost Estimates

Residential Rain Garden

- Shallow-type rain garden incorporating in-situ soils and no under drain system i.e., infiltration type bioretention
- Planting materials moderately expensive
- Labor costs are negligible, i.e., homeowner, garden group, or volunteers provide labor
- No heavy construction equipment utilized, i.e., mostly hand labor or small power equipment
- Disturbed area is small enough to avoid permits and fees - considered homeowner landscaping project
- Contributing drainage area assumed to be 1 acre.

Residential Lot in Subdivision

- Average cost per facility installed, assuming 100 lot subdivision
- All facilities have under drain systems
- Planning, design, and construction costs are all pro-rated as portion of the overall site cost work
- Sediment control, permits, fees, and technical plan approval are required
- Many facilities will be constructed simultaneously.

Residential Lot Single Lot

- Site planning costs increased, but no subdivision review or preliminary plan costs included
- On-lot sediment control devices required (sediment control plan costs not included)
- Design costs increased substantially due to small scale of project requiring same level of engineering
- 4. Closeout costlier due to as-built requirements.

Commercial - New

- Facility costs for site lower than single residential lot because of the greater amount of other site work
- Drainage area to the proposed facility is no greater than 1 acre
- There are no removal costs attributable to the bioretention area
- Storm drainage discharge system not part of bioretention costs- associated with general site costs.

Commercial – Retrofit

- Cost data information derived from proprietary software
- Resource data information (salaries, materials & duration) included in each task and sub-task to find final cost
- Retrofit costs higher than new construction cost due to economies of scale
- Design costs are less expensive because existing drainage conveyance system already in place
- Preliminary Plan costs are not included in the cost calculations.

Section Eight References

American Society of Civil Engineers (ASCE), 1985. *Final Report of the Task Committee on Stormwater Detention Outlet Structures*, ASCE, New York, NY.

American Society of Civil Engineers (ASCE) and Water Environment Federation (WEF), 1992. *Design and Construction of Urban Stormwater Management Systems*, ASCE, Manuals and Reports of Engineering Practice, No. 77, New York, NY and Water Environment Federation, Manual of Practice No. FD-20, Alexandria, VA.

American Society of Civil Engineers (ASCE) and Water Environment Federation (WEF), 1998. *Urban Runoff Quality Management*, ASCE, Manuals and Report of Engineering Practice No. 87, Reston, VA. WEF, Manual of Practice No. 23, Alexandria, VA.

Arnold, J. A., D. E. Line, S. W. Coffey and J. Spooner (Ed.), 1993. *Stormwater Management Guidance Manual*. North Carolina Cooperative Extension Service and North Carolina Division of Environmental Management, Raleigh, NC, 1993.

Barfield, B. J., R. Warner and C. T. Haan, 1981. *Applied Hydrology and Sedimentology for Disturbed Lands*. Oklahoma Technical Press, Stillwater, OK.

Barfield, B. J. and J. C. Hayes, 1988. Design of Grass Waterways for Channel Stabilization and Sediment Filtration. In *Handbook of Engineering in Agriculture*, Vol. II, *Soil and Water Engineering*, CRC Press, Boca Raton, FL.

Barfield, B. J., J. C. Hayes, A. W. Fogle and K. A. Kranzler, 1996. The SEDIMOT III Model of Watershed Hydrology and Sedimentology. Proceedings of Sixth Federal Interagency Sedimentation Conference, March, 1996.

Barret, M.E., R. D. Zuber, E. R. Collins, J. F. Malina, R. J. Charbeneau and G. H. Ward, 1993. A Review and Evaluation of Literature Pertaining to the Quantity and Control of Pollution from Highway Runoff and Construction, Center for Research in Water Resources, Bureau of Engineering Research, University of Texas at Austin, Austin, TX.

Boutiette, L. N. and C. L. Duerring, 1994. Massachusetts Nonpoint Source Management Manual. The Megamanual: A Guidance Document for Municipal Officials, Massachusetts Department of Environmental Protection, Office of Watershed Management, Nonpoint Source Program, Boston, MA.

Chapra, S. C., 1997. *Surface Water Quality Modeling*. McGraw Hill, New York.

Chesapeake Bay Program, 1995. Water Quality Functions of Riparian Forest Buffer Systems in the Chesapeake Bay Watershed. Technology Transfer Report CBP / TRS 134/95. Annapolis, MD.

Chesapeake Research Consortium (CRC), 1996. Design of Stormwater Filtering Systems, prepared by the Center for Watershed Protection, Silver Spring, MD, for the Chesapeake Research Consortium, Inc., Solomons Island, MD.

City of Austin, TX, 1988. Water Quality Management. In Environmental Criteria Manual. Environmental and Conservation Services. Austin, TX

Chow, V. T., 1959. Open-Channel Hydraulics, McGraw Hill, New York, NY.

Clar, M. L. and R. Green, 1993. Design Manual for Use of Bioretention in Storm Water Management, prepared for the Department of Environmental Resources, Watershed Protection Branch, Prince George's County, MD, prepared by Engineering Technologies Associates, Inc. Ellicott City, MD, and Biohabitats, Inc., Towson, MD.

Clar, M., L. Coffman, R. Green and S. Bitter, 1994. Development of Bioretention Practices for Storm Water Management, Chapter 2, In: *Current Practices in Modeling the Management of Storm Water Impacts*, William James (Ed.), Lewis Publishers.

Colorado Department of Transportation, 1992. Erosion Control and Stormwater Quality Guide, Colorado Department of Transportation.

Davis, A., M. Shokouhian, H. Sharma and C. Minami, 1998. Optimization of Bioretention Design for Water Quality and Hydrologic Characteristics. Report 01-04-31032. Final report to Prince George's county, MD, Environmental Engineering Program, University of Maryland, College Park, MD.

DeGroot, W. G., 1982. Stormwater Detention Facilities, ASCE, New York, NY.

Dillaha, T., J. Sherrad and D. Lee, 1989. Long-term Effectiveness of Vegetative Buffer Strips. *Water Environment and Technology*, 1:418-421.

Dillaha, T.A., R. B. Reneau, S. Mostaghimi and D. Lee, 1989. "Vegetative Filter Strips for Agricultural Nonpoint Source Pollution Control." *Transactions ASAE*, Blacksburg, VA.

Driscoll, E. D., D. DiToro, D. Gaboury and P. Shelly, 1986. Methodology for Analysis of Detention Basins for Control of Urban Runoff Quality. Report No. EPA 440/5-87=01 (NTIS No. PB87-116562), EPA, Washington, DC.

Driscoll, E. D., G. E. Palhegyi, E. W. Strecker and P. E. Shelley, 1989. Analysis of Storm Events, Characteristics for Selected Rainfall Gauges throughout the United States. EPA, Washington, DC.

Driscoll, E. and P. Mangarella, 1990. Urban Targeting and BMP Selection. EPA, Contract No. 68-C8-0034, Woodward-Clyde Consultants, Oakland, CA.

Florida Department of Transportation, 1994. Water Quality Impact Evaluation Manual Training, Course No. BT-05-0009, Florida Department of Transportation.

Foster, G. R., R. A. Young and W. H. Neibling, 1985. Sediment Composition for Nonpoint Source Pollution Analyses. *Transactions ASAE*, 28(1):133-146.

GKY and Associates, Inc., 1991. BMP Facilities Manual, for the Rappahannock Area Development Commission, Fredericksburg, VA.

-
- Guo, C.Y. and B. R. Urbonas, 1995. Special Report to the Urban Drainage and Flood Control District on Stormwater BMP Capture Volume Probabilities in United States, Denver, CO.
- Haan, C. T. and B. J. Barfield, 1978. Hydrology and Sedimentology of Surface Mined Lands. College of Engineering, University of Kentucky, pp. 296.
- Haan, C. T., B. J. Barfield and J. C. Hayes, 1994. Design Hydrology and Sedimentology for Small Catchments. Academic Press, San Diego, CA.
- Hartigan, J. P., 1988. Basis for Wet Detention Basis BMP's, paper presented in the Proceedings of an Engineering Foundation Conference on Current Practice and Design Criteria for Urban Quality Control, Potosi, MO. L. Roesner, B. Urbonas, and M. Sonnen (Ed.), ASCE, New York, NY.
- Hayes, J. C., B. J. Barfield, and R. I. Barnhisel, 1984. Performance of Grass Filters under Laboratory and Field Conditions. Transactions ASAE, 27(5): 1321-1331.
- Hayes, J. C., B. J. Barfield, K. F. Holbrook and B. Bates, 2001. Loading and Best Management Model for South Carolina Office of Coastal Resource Management. Report submitted to SCOCRM by Woolpert, Inc. of Charlotte, NC, December 31, 2001.
- Horner, R. R., 1988. Biofiltration for Storm Runoff Water Quality Control, prepared for the Washington State Department of Ecology, Center for Urban Water Resources Management, University of Washington, Seattle, WA.
- Huber, W. C. and R. C. Dickinson, 1988. Storm Water Management Model. User's Manual, Version 4 EPA 600/3-88/001a (NTIS PB88-236641/AS), EPA, Cincinnati, OH.
- Hydrologic Engineering Center, 1975. Storage, Treatment, Overflow, Runoff Model, STORM, User Manual. Generalized Computer Program 723-S8-L7520, Hydrologic Engineering Center, U.S. Army Corps of Engineers, Davis, CA.
- Johanson, R. C., J. C. Imhoff, J. L. Kittle and A. S. Donigian, 1984. Hydrologic Simulation program—Fortran (HSPF): User Manual. Release 8, EPA 600/3-84-006, EPA, Athens, GA.
- Jones, R.C., A. Via-Norton, and D.R. Morgan, 1997. Bioassessment of BMP Effectiveness in Mitigating Stormwater Impacts on Aquatic Biota. In L. A. Roesner (Ed.), Effects of Watershed Development and Management on Aquatic Ecosystems, ASCE, New York, NY.
- Khan, Z., C. Thrush, P. Cohen, L. Kuzler, R. Franklin, D. Field, J. Koon, and R. Homer, 1993. Biofiltration Swale Performance Recommendations and Design Considerations, Washington Department of Ecology, University of Washington, Seattle, WA.
- Knisel, W. G., 1980. CREAMS: A Field Scale Model for Chemicals, Runoff, and Erosion from Agricultural Management Systems. Conservation Research Report No. 26, U.S. Department of Agriculture, Washington, DC.
- Knisel, W. G., 1985. Use of Computer Models in Managing Nonpoint Pollution from Agriculture. Proceedings, Non-point Pollution Abatement Symposium, V. Novotny (Ed.), Marquette University, Milwaukee, WI.
- Kouwen, N., R. M. Li and D. B. Simons, 1981. Flow Resistance in Vegetated Waterways. Transactions of the ASAE, 24(3):684-690.

-
- Lafren, J. M., L. J. Lane and G. R. Foster, 1991. WEPP—A New Generation of Erosion Prediction Technology. *Journal of Soil and Water Conservation*. 46(1):34-38.
- Lane, L. J., and M. A. Nearing (Ed.), 1989. USDA—Water Erosion Prediction Project: Hillslope Profile Model Documentation. NSERL Rep. No. 2, USDA ARS National Soil Erosion Research Laboratory, West Lafayette, IN.
- Leonard, R. A. and W. G. Knisel, 1986. Selection and Application of Models for Nonpoint Source Pollution and Resource Conservation. *Agricultural Source Pollution: Model Selection and Application*. A Giorgini and F. Zingales, (Ed.), Elsevier, Amsterdam.
- Lindley, M. R., B. J. Barfield, J. C. Ascough II, B. N. Wilson and E. W. Stevens, 1998. The Surface Impoundment Element for WEPP. *Transactions ASAE*, 14(3):249-256.
- Magette, W., R. Brinsfield, R. Palmer and J. Wood, 1989. Nutrient and Sediment Removal by Vegetated Filter Strips. *Transactions of the American Society of Agricultural Engineers*. 32(2):663-667
- Maryland Department of the Environment (MDE), 2000. 2000 Maryland Stormwater Design Manual, Volumes I & II, prepared by the Center for Watershed Protection and the Maryland Department of the Environment, Water Management Administration, Baltimore, MD.
- Maxted, J. and E. Shaver, 1997. The Use of Retention Basins to Mitigate Stormwater Impacts on Aquatic Life. In L. A. Roesner (Ed.), *Effects of Watershed Development and Management on Aquatic Ecosystems*, ASCE, New York, NY.
- McCuen, R.H., G. Moglen, E. Kistler and P. Simpson, 1987. Policy Guidelines for Controlling Stream Channel erosion with Detention Basins, prepared by the Department of Civil Engineering, University of Maryland, College Park, MD, prepared for the Water Management Administration, Maryland Department of the Environment, Baltimore, MD.
- Meadows, M. E. and E. W. Ramsey III, 1991. South Carolina Regional Synthetic Unit Hydrograph Study: Methodology and Results. Project Completion Report, Volume II Submitted to U.S. Geological Survey, Reston, VA. College of Engineering, University of South Carolina, Columbia, SC, 33pp.
- Meadows, M. E., 1991. Extension of SCS TR-55 and Development of Single Outlet Detention Pond Performance Charts for Various Unit Hydrograph Peak Rate Factors. Project Completion Report, Volume III. Submitted to U. S. Geological Survey, Reston, VA. College of Engineering, University of South Carolina, Columbia, SC.
- Meadows, M. E., 2000. Personal communication to B. J. Barfield, OK State University, Stillwater, OK on use of PRF factors. Dept. of Civil Engineering, University of South Carolina Columbia, SC.
- Metropolitan Washington Council of Governments, 1993. Guidance Report 1: Riparian Buffer Programs, A Guide to Developing and Implementing a Riparian Buffer Program as an Urban Stormwater Best Management Practice. Washington, DC.
- Nearing, M. A., G. R. Foster, L. J. Lane and S. C. Finker, 1989. A Process-based Model for USDA Water Erosion Prediction Project technology. *Transactions ASAE* 32(5): 1587-93
- Northern Virginia Planning District Commission and Engineers Surveyors Institute, 1992. Northern Virginia BMP Handbook, A Guide to Planning and Designing Best Management Practices in Northern Virginia, Annandale, VA.

-
- Pitt, R., 1994. Small Storm Hydrology. University of Alabama-Birmingham. Unpublished manuscript. Presented at design of stormwater quality management practices, Madison, WI.
- Prince George's County (PGC), Maryland, 1997. *Low-Impact Development Design Manual*, prepared by Tetra Tech, Inc, Laurel, MD, prepared for Prince George's County, MD.
- Ree, W. O., 1949. Hydraulic Characteristics of Vegetation for Vegetated Waterways. *Agricultural Engineer*. 30:184-189.
- Renard, K. G., G. R. Foster, G. R. Weesies, D. K. McCool and D. C. Yoder, 1992. Predicting Soil Erosion by Water, a Guide to Conservation Planning with the Revised Universal Soil Loss Equation. ARS Publication.
- Rushton, B. (2004). Photograph of parking lot filter strip, Tampa Bay Aquarium, Southwest Florida Water Management District, Brooksville, FL.
- Schueler, T., 1987. Controlling Urban Runoff: A Practical Manual for Planning and Designing Urban BMPs. Metropolitan Washington Council of Governments, Washington, DC.
- Schueler, T. R., F. J. Galli, L. Herson, P. Kumble and D. Shepp, 1991. Developing Effective BMP Systems for Urban Watersheds. Urban Nonpoint Workshops. New Orleans, LA, January 27-29, 1991.
- Schueler, T. R. and M. Helfrich, 1988. Design of Extended Detention Wet Pond Systems, paper presented in the Proceedings of an Engineering Foundation Conference on Current Practice and Design Criteria for Urban Quality Control, Potosi, MO, L. Roesner, B. Urbonas, and M. Sonnen (Ed.), ASCE, New York, NY.
- Schueler, T. R. and J. Lugbill, 1990. Performance of Current Sediment Control Measures at Maryland Construction Sites. Metropolitan Washington Council of Governments, pp. 90.
- Schueler, T. R., P. Kumble, and M. Heraty, 1992. A Current Assessment of Urban Best Management Practices: Techniques for Reducing Nonpoint Source Pollution in the Coastal Zone, Anacostia Research Team, Metropolitan Washington Council of Governments, Washington, DC.
- Schueler, T., 1995. The Architecture of Urban Stream Buffers. *Watershed Protection Techniques*, Vol 1, No. 4. Silver Spring, Maryland: Center for Watershed Protection, 1995.
- Schueler, T. R. and H. K. Holland, 2000. The Practice of Watershed Protection – Article 17. Center for Watershed Protection, 8391 Main Street, Ellicott City, MD 21043.
- Stribling, J. B., 2001. “Relating Instream Biological Condition to BMP Activities in Watersheds”, paper presented at the Conference on Linking Stormwater BMP Designs and Performance to Receiving Water Impacts Mitigation, Snowmass, CO, United Engineering foundation, New York, NY.
- Stahre, P. and B. Urbonas, 1990. Storm Water Detention for Drainage, Water Quality, and CSO Management. Prentice-Hall, Englewood Cliffs, NJ.
- Tapp, J. S., A. D. Ward and B. J. Barfield, 1982. Designing Sediment Ponds for Theoretical Detention Time. Proceedings of the ASCE, 108(HY1):17-24, 1982.
- Temple, D.M., K. M. Robinson, R. M. Ahring and A.G. Davis, 1987. Stability Design of Grass-Lined Open Channels. ARS Agricultural Handbook 667. US Department of Agriculture, Washington, DC

Terstriep, M. L. and J. B. Stall, 1974. The Illinois Urban Drainage Area Simulator, ILLUDAS. ISWS-74-Bul 58. State of Illinois, Department of Registration and Education, Urbana, IL.

Thomson, N. R., E. A. Mcbean, W. Snodgrass, and I. B. Monstrenko, 1997. Highway Storm Water Runoff Quality – Development of Surrogate Parameter Relationship. *Water, Air, and Soil Pollution*. 94(3-4):307-347.

Tollner, E. W., B. J. Barfield, C. T. Haan, and T. Y. Kao, 1976. Suspended Sediment Filtration Capacity of Simulated Vegetation. *Transactions ASAE*, 19(4): 678-672.

Tollner, W. W., B. J. Barfield, and J. C. Hayes, 1982. Sedimentology of Erect Vegetal Filters. *Proceedings ASCE* 108 (HY12):1518-1531.

U.S. Department of Agriculture (USDA), 1972, 1973. Hydrology, Sect. 4, Soil Conservation National Engineering Handbook, USDA, Soil Conservation Service, Washington, DC.

U.S. Department of Agriculture (USDA), 1973. A Method for Estimating Volume and Rate of Runoff in Small Watersheds. SCS-TP-149, USDA, Soil Conservation Service, Washington, DC.

U.S. Department of Agriculture (USDA), 1979. Engineering Field Manual. USDA, Soil Conservation Service, Washington, DC.

U.S. Department of Agriculture (USDA), 1985. National Engineering Handbook. Section 4, Chapter 7. National Resources Conservation Service. <http://www.wcc.nrcs.usda.gov/water/quality/common/neh630/630ch7.pdf>.

U.S. Department of Agriculture (USDA), 1986. Urban Hydrology For Small Watersheds. Soil Conservation Service, Engineering Division. Technical Release 55 (TR-55).

U.S. Department of Agriculture (USDA), 1982. Project Formulation - Hydrology. Soil Conservation Service, Engineering Division. Technical Release 20 (TR-20).

U.S. Environmental Protection Agency (EPA), 1983. Results of Nationwide Urban Runoff Program (NURP), Final Report. EPA, Water Planning Division, Washington, DC.

U.S. Environmental Protection Agency (EPA), 2000a. Low Impact Development Design Strategies: An Integrated Design Approach. Prepared by Tetra Tech, Inc., Fairfax, VA. Prepared for Department of Environmental Resources, Prince George's County, MD, funding provided by the EPA, Washington, DC.

U.S. Environmental Protection Agency (EPA), 2000b. Low Impact Development Hydrologic Analysis. Prepared by Tetra Tech, Inc., Fairfax, VA Prepared for Department of Environmental Resources, Prince George's County, MD, funding provided by the EPA, Washington, DC.

Urban Drainage and Flood Control District (DUDFCD), 1999. Urban Storm Drainage Criteria Manual, Volume 3, Best Management Practices, B. Urbonas (Ed.), Urban Drainage Flood Control District, Denver, CO, 1992, revised and updated 1999.

Urbonas, B. R., C.Y. Guo and S. Tucker, 1990. Optimization of Stormwater Quality Capture Volume, In Urban Stormwater Quality Enhancement - Source Control, Retrofitting, and Combined Sewer Technology. ASCE, New York, NY.

Urbonas, B.R. and P. Stahre, 1993. Stormwater - Best Management Practices Including Detention. Prentice Hall, Englewood Cliffs, NJ.

Virginia Department of Conservation and Recreation (VA DEC), 1999. Virginia Stormwater Management Handbook. Virginia Department of Conservation and Recreation, Division of Soil and Water Conservation.

Vogel, J., B.J. Barfield and J. C. Hayes. 2001. A Three Layer Bioretention Cell. Paper presented at the 2001 Annual Meeting of the American Institute of Hydrology. Minneapolis, MN.

Washington State Department of Transportation. 1995. Highway Runoff Manual, Washington State Department of Transportation.

Whipple, W. and Hunter, J.V. 1981. Settleability of Urban Runoff Pollution, Journal of the Water Pollution Control Federation, 53, 1726.

Williams, J. R. and A. D. Brandt, 1972. Sediment Yield Computed with Universal Equation. Proceedings ASCE. 98 (HY12): 2087-2098

Wilson, B. N., B. J. Barfield and I. D. Moore. 1982. A Hydrology and Sedimentology Watershed Model. Part I. Modeling Technique. Department of Agricultural Engineering, University of Kentucky, Lexington, KY.

Winer, R., 2000. National Pollutant Removal Performance Database for Stormwater Treatment Practices, 2nd Edition, prepared by the Center for Watershed Protection, Ellicott City, MD, prepared for the EPA Office of Science and Technology, Washington, DC.

Winogradoff, D., 2001. Bioretention Manual, Draft, Programs and Planning Division, Department of Environmental Resources, Prince George's County, MD.

Wong, S. L., and R. H. McCuen, 1981. "The Design of Vegetative Buffer Strips for Runoff and Sediment Control," Report to the Maryland Coastal Zone Management Program, University of Maryland, College Park, Maryland, 1981. (Also Appendix J, in Stormwater Management in Coastal Areas, ASCE, NY, NY, 1982).

Wong, T. H. F. Duncan, H. P., Fletcher, T. D. and Jenkins, G.A. 2001. A Unified Approach to Modeling Urban Stormwater Treatment, Proceedings of the 2nd South Pacific Stormwater Conference, Auckland, New Zealand, 27-29, June, 2001, pp. 319-327.

Yousef, Y.A., M. P. Wanielista, H. H. Harper, D. B. Pearce and R. D. Tolbert, 1985. Best Management Practices - Removal of Highway Contaminants by Roadside Swales, FL-ER-30-85, Florida Department of Transportation, University of Central Florida, Department of Civil Engineering and Environmental Sciences, Tallahassee, FL.

Young, G. K., S. Stein, P. Cole, T. Kammer, F. Graziano and F. Bank, 1996. Evaluation and Management of Highway Runoff Water Quality, U.S. Department of Transportation, Federal Highway Administration, Publication No. FHWA-PD-96-032.

Yu, S.L. and R. J. Kaighn, 1992. VDOT Manual of Practice for Planning Stormwater Management, Federal Highway Administration, FHWA/VA-R13, Virginia Department of Transportation, Virginia Transportation Research Council, Charlottesville, VA.

Yu, S.L., S. L. Barnes and V. W. Gerde, 1993. Testing of Best Management Practices for Controlling Highway Runoff, FHWA/VA-93-R16, Virginia Department of Transportation, Virginia Transportation Research Council, Charlottesville, VA.

Yu, S.L., 1993. Stormwater Management for Transportation Facilities, National Cooperative Highway Research Program, Synthesis of Highway Practice, 174. Transportation Research Board, National Research Council, Washington, DC.

Yu, S.L., X. Zhang, A. Earles, and M. Sievers, 1999. "Field Testing of Ultra-urban BMPs". Proceedings of the 26th Annual Water Resources Planning and Management Conference, E. Wilson (Ed.), ASCE, June 6-9, 1999, Tempe AZ.

Appendix A General Landscaping Guidance for Best Management Practices

Introduction

Landscaping is a critical element to improve both the function and appearance of stormwater BMPs. This Appendix provides general landscaping Guidance for all stormwater BMPs which has been adopted from Appendix A of the Maryland Stormwater Design Manual (MDE 2000). The MDE (2000) design manual also provides guidance for specific stormwater practices, plant selection, key factors in selecting plant material for stormwater landscaping (including hardiness zones, physiographic regions, and hydrologic zones), and a detailed list of native woody and herbaceous species.

The MDE (2000) design manual Appendix A as a whole provides suitable landscaping for the mid Atlantic region. For other regions of the country, similar but more regionally relevant or State and municipal specific guidance should be used. The excerpt contains general information suitable for a large portion of the country.

General Landscaping Guidance for All Stormwater BMPs

- - Trees, shrubs, and/or any type of woody vegetation are not allowed on an embankment.
- Plant trees and shrubs at least 15 ft away from the toe of slope of a dam.
- Trees or shrubs known to have long taproots should not be within the vicinity of the earth dam or subsurface drainage facilities.
- Plant trees and shrubs at least 25 ft away from perforated pipes.
- Plant trees and shrubs at least 25 ft away from a principal spillway structures.
- Provide 15 foot clearance from a non-clogging, low flow orifice.
- Herbaceous embankment plantings should be limited to 10 inches in height.
- Use erosion control mats and fabrics in channels to reduce the potential for erosion.
- Stabilize all emergency spillways with plant material that can withstand strong flows. Root material should be fibrous and substantial but lacking a taproot.
- Sod channels that are not stabilized with erosion control mats.
- Divert flows temporarily from seeded areas until stabilized.
- Check water tolerances of existing plant materials prior to inundation of area.
- Stabilize aquatic and safety benches with emergent wetland plants and wet seed mixes.
- Do not block maintenance access to structures with trees or shrubs.
- To reduce thermal warming, shade inflow and outflow channels as well as southern exposures of ponds.
- Avoid plantings that will require routine or intensive chemical applications (i.e. turf area).
- Have soil tested to determine if there is a need for amendments.

-
- Native plant species should be specified over exotic or foreign species because they are well adapted to local on-site soil conditions and require little or no additional amendments.
 - Decrease the areas where turf is used. Use low maintenance ground cover to absorb run-off.
 - Plant stream and water buffers with trees, shrubs, ornamental grasses, and herbaceous materials where possible, to stabilize banks and provide shade
 - Maintain and frame desirable views. Be careful not to block views at entrances, exits, or difficult road curves. Screen unattractive views into the site. Aesthetics and visual characteristics should be a prime consideration.
 - Use plants to prohibit pedestrian access to pools or steeper slopes.
 - The designer should carefully consider the long-term vegetation management strategy for the BMP, keeping in mind the "maintenance" legacy for the future owners. Provide a planting surface that can withstand the compaction of vehicles using maintenance access roads. Make sure the facility maintenance agreement includes requirements to ensure vegetation cover in perpetuity.
 - If a BMP is likely to receive excessive amounts of deicing salt, salt tolerant plants should be used.
 - Provide signage for:
 - % SWM areas to help educate the public
 - % wildflower areas, when possible, to designate limits of mowing
 - % avoid the overuse of any plant materials
 - % preserve existing natural vegetation when possible.

It is necessary to test the soil in which you are about to plant in order to determine the following:

- pH - whether acid, neutral, or alkaline
- major soil nutrients - nitrogen, phosphorus and potassium
- minerals - such as chelated iron, lime.

Have soil samples analyzed by experienced and qualified individuals, such as those at the local Agricultural Extension Office, who will explain in writing the results, what they mean, as well as what soil amendments would be required. Certain soil conditions, such as marine clays, can present serious constraints to the growth of plant materials and may require the guidance of qualified professionals. When poor soils can not be amended, seed mixes and plant material must be selected to establish ground cover as quickly as possible.

Areas that recently have been involved in construction can become compacted so that plant roots cannot penetrate the soil. Also seeds will lie on the surface of compacted soils and are often washed away or eaten by birds. For planting success, soils should be loosened to a depth of 3 to 5 in. Hard soils may require disking to a deeper depth. The soil should be loosened regardless of the ground cover. This will improve seed contact with the soil, increase germination rates, and allow the roots to penetrate the soil. For areas to be sodded, disking is necessary so that the roots can penetrate the soil. Providing good growing conditions can prevent poor vegetative cover. This saves money because vegetation will not need to be replanted. Whenever possible, topsoil should be spread to a depth of 4 to 8 in. and lightly compacted to minimum thickness of 4 in. This provides organic matter and important nutrients for the plant material. The use of topsoil allows vegetation to become established faster and roots to penetrate deeper. This ensures quicker and more complete stabilization, making it less likely that the plants will wash out during a heavy storm.

If topsoil has been stockpiled in deep mounds for a long period of time, it is necessary to test the soil for pH as well as microbial activity. If the microbial activity has been destroyed, it is necessary to inoculate the soil after application.

Remember that newly installed plant material requires water in order to recover from the shock of being transplanted. Be sure that some source of water is provided, especially during dry periods. This will reduce plant loss and provide the new plant materials with a chance to establish root growth.

Appendix B Specifications for Grassed Swales and Filter Strips

Material Specifications

The recommended construction materials for open channels and filter strips are taken from the Maryland Stormwater Design Manual (2000) and are further detailed in Table B-1. Designers should refer to local guidance, if available.

Dry Swales

Specifications for dry swales are:

- permeable soil mixture (20 to 30 in. deep) should meet the bioretention “planting” soil specifications
- check dams, if required, placed as specified.
- system to have 6 in. of freeboard, minimum above 2-yr water surface elevation
- side slopes to be 3:1 minimum (4:1 or flatter is preferred)
- no gravel or perforated pipe under driveways
- bottom of facility to be above the seasonably high water table
- seed with flood/drought resistant grasses
- longitudinal slope to be 4% maximum
- bottom width to be 2 ft minimum and 8 ft maximum to avoid braiding; larger widths may be used if a proper berm is specified.

Wet Swales

Follow above information for dry swales, with the following exceptions:

- the seasonally high water table may inundate the swale; but not above the design bottom of the channel [NOTE: if the water table is stable within the channel, the V_{wQ} storage may start at this point]
- excavate into undisturbed soils
- do not use an under drain system.

Filter Strips

Specifications for filter strips are

- construct pea gravel diaphragms 1 ft wide minimum, and 2 ft deep minimum
- pervious berms to be a sand/gravel mix by adding 20% gravel and reducing clay component (<10%) accordingly (see Table 7-3 for bioretention planting media specifications).
- berms to have overflow weirs with 6 in. minimum head
- slope range to be 2% minimum to 6% maximum.

Plant Selection

Recommended grass species for use in establishing permanent ground cover are provided in Table B-2.

Operation and Maintenance of Vegetative Biofilters

The following is adopted from ASCE/WEF (1998) manual of practice:

To keep biofilters operating properly, keep all inlet flow spreaders even and free of debris. Remove debris for aesthetic reasons. Mow grass-covered biofilters regularly during the growing season to promote growth and pollutant uptake. Remove cuttings and dispose of them properly or through composting. If the objective is to prevent nutrient transport, mow grasses or cut emergent wetland plants to a low height, but still above the maximum flow depth at the end of the growing season. For trapping floatables and debris pollution control objectives, let the plants stand at a height exceeding the design water depth by at least 50mm (2in.) at the end of the growing season.

Remove sediment by hand with a flat-bottomed shovel during the summer months whenever sediment covers vegetation or begins to reduce the biofilter's capacity. Reseed damaged or recently maintained areas immediately with a mix used for initial establishment or use grass plugs from adjacent up-slope areas. If possible, redirect flow until new grass is firmly established. Otherwise, cover the seeded areas with a high-quality erosion control fabric.

Inspect biofilters periodically, preferably monthly, especially after heavy runoff. Maintain clean curb cuts to avoid soil and vegetation buildup. Educate local residents about the importance of keeping biofilters free of lawn debris and pet waste. Base roadside ditch cleaning on hydraulic analysis. Remove only the amount of sediment necessary to restore needed hydraulic capacity, leaving as much of the vegetation in place as possible. Eventually, sufficient sediment will be trapped that the entire biofilter will need to be removed with the sediment and reconstructed to begin a new cycle of stormwater quality control.

Table B-1 Materials Specifications for Grass Swale and Filter Strips (MDE, 2000)

Material	Specification	Size	Notes
<i>Dry swale soil</i>	USCS; ML, SM, SC	n/a	soil with a higher percent organic content is preferred
<i>Dry Swale sand</i>	ASTM C-33 fine aggregate concrete sand	0.02 to 0.04 in.	
<i>Check Dam (pressure treated)</i>	AWPA Standard C6	6 by 6 or 8 by 8 in.	do not coat with creosote; embed at least 3 ft into side slopes
<i>Check Dam (natural wood)</i>	Black Locust, Red Mulberry, Cedars, Catalpa, White Oak, Chestnut Oak, Black Walnut	6 to 12 in. diameter; notch as necessary	do not use the following, as these species have a predisposition towards rot: Ash, Beech, Birch, Elm, Hackberry, hemlock, Hickories, Maples, Red and Black Oak, Pines, Poplar, Spruce, Sweetgum, Willow
<i>Filter strip sand/gravel pervious berm</i>	sand: per dry swale sand gravel; AASHTO M-43	sand: 0.02 to 0.04 in. gravel: ½ to 1 in.	mix with approximately 25% loan soil to support grass cover crop; see Bioretention planting soil notes for more detail.
<i>Pea gravel diaphragm and curtain drain</i>	ASTM D 448	varies (No. 6) or (1/8 to 3/8 in.)	use clean bank-run gravel
<i>Underdrain gravel</i>	AASHTO M-43	0.25 to 0.75 in.	
<i>Under drain</i>	F 758, Type PS 28 or AASHTO M-278	4 to 6 in. rigid schedule PVC or SDR35	3/8" perforations every 6 in. on center, 4 bodes per row; minimum of 3 in. of gravel over pipes: not necessary underneath pipes
<i>Geotextile</i>	Class "C" – apparent opening size (ASTM-D-4751), grab tensile strength (ASTM-D- 4632), puncture resistance (ASTM-D-4833)	n/a	
<i>Riprap</i>	Use local public works agency standards	size per local public works requirements based on 10-yr design flows	

Table B-2 Common Grass Species for Open Channels (MDE, 2000)

Common Name	Scientific Name	Notes
Big Bluestem	<i>Andropogon gerardii</i>	Warm, not for Wet Swale
Creeping Bentgrass	<i>Agrostis palustris</i>	Cool
Red Fescue	<i>Festuca rubra</i>	Cool, not for Wet Swale
Reed Canary grass	<i>Phalaris arundinacea</i>	Cool, Wet Swale
Redtop	<i>Agrostis alba</i>	Cool
Smooth Brome	<i>Bromus inermis</i>	Cool, not for Wet Swale
Switch grass	<i>Panicum virgatum</i>	Warm

Note 1: These grasses are sod-forming and can withstand frequent inundation, and are thus ideal for the swale or grass channel environment. Most are salt-tolerant, as well.

“Cool” refers to cool season grasses and “Warm” refers to warm season grasses.

Note 2: Where possible, one or more of these grasses should be in the seed mixes.

Note 3. Other grasses may be more suitable for other parts of the country.

Appendix C Testing Requirements for Subsoils for Infiltration

The following was adopted from the Maryland Stormwater Design Manual, Appendix D.1 (2000) and was entitled “Testing Requirements for Subsoils for Infiltration, Bioretention and Sand Filter Subsoils.”

General Notes Pertinent to All Testing

For infiltration trench and basin practices, a minimum field infiltration rate (*i*) of 0.52 in/hr is required; lower rates preclude the use of these practices. For bioretention practices, no minimum infiltration rate is required if these facilities are designed with a “day-lighting” underdrain system; otherwise these facilities also require a 0.52 in/hr rate.

The number of required borings is based on the size of the proposed facility. Testing is done in two phases: (1) Initial Feasibility and (2) Concept Design.

Testing is to be conducted by a qualified professional as per local jurisdiction.

Infiltration testing data shall be documented, and include a description of the infiltration testing method. This is to ensure that the tester understands the procedure.

Initial Feasibility Testing

Feasibility testing is conducted to determine whether full-scale testing is necessary, screen unsuitable sites, and reduce testing costs. A soil boring is not required at this stage. However, a designer or landowner may opt to engage Concept Design Borings per Table C-1 at their discretion, without feasibility testing.

Initial testing involves either one field test per facility, regardless of type or size, or previous testing data, such as one or more of the following:

- on-site septic percolation testing, within 200 ft of the proposed BMP location, and on the same contour which can establish initial rate, water table and/or depth to bedrock
- geotechnical report on the site prepared by a qualified geotechnical consultant
- NRCS County Soil Mapping showing an unsuitable soil group such as a hydrologic group “D” soil in a low-lying area or the presence of expansive clays.

If the results of initial feasibility testing as determined by a qualified professional show that an infiltration rate of greater than 0.52 in/hr is probable, then the rate of Concept Design test pits is described in Table C-1. An encased soil boring may be substituted for a test pit, if desired.

Table C-1 Infiltration Testing Summary

Type of Facility	Initial Feasibility Testing	Concept Design Initial Testing Yields	
		Rate greater than 0.52 in/hr	Rate lower than 0.52 in/hr
Infiltration trench	1 field percolation test, test pit not required	1infiltration test and 1 test pit per 50 ft of trench	not acceptable practice
Infiltration basin	1 field percolation test, test pit not required	1 infiltration test and 1 test pit per 200 ft ² of basin area	not acceptable practice
Bioretention	1 field percolation test, test pit not required	1 infiltration test and 1 test pit per 200 ft ² of filter area (no underdrains required)*	underdrains required

* underdrain installation is still strongly recommended

Test Pit/Boring Requirements

- Excavate a test pit or dig a standard soil boring to a depth of 4 ft below the proposed facility bottom
- Determine depth to groundwater table (refer to Table C-2) upon initial digging or drilling, and again 24 hr later
- Conduct Standard Penetration Testing (SPT) every 2 ft to a depth of 4 ft below the facility bottom
- Determine USDA or Unified Soil Classification (USC) System textures at the proposed bottom and 4 ft below the bottom of the proposed BMP
- Determine depth to bedrock (if within 4 ft of proposed bottom)
- The soil description should include all soil horizons
- The location of the test pit or boring shall correspond to the BMP location
- Test pit/soil boring stakes should be left in the field for inspection purposes and should be clearly labeled as such.

Table C-2 Minimum Depth to Seasonably High Water Table

Region	Depth to water table for infiltration
Coastal Plain	2
Other Regions	4

Infiltration Testing Requirements

- Install casing (solid 5 in. diameter, 30 in. length) to 24 in. below the proposed BMP bottom (see Figure C-1).
- Remove any smeared soiled surfaces and provide a natural soil interface into which water may percolate. Remove all loose material from the casing. Upon the tester’s discretion, a 2 in. layer of coarse sand or fine gravel may be placed to protect the bottom from scouring and sediment. Fill casing with clean water to a depth of 24 in. and allow to pre-soak for 24 hr.
- After 24 hr, refill casing with another 24 in. of clean water and monitor water level (measured drop from the top of the casing) for 1 hr. Repeat this procedure (filling the casing each time) three additional times, for a total of four observations. Upon the tester’s discretion, the final field rate may either be the average of the four observations, or the value of the last observation. The final rate shall be reported in in/hr.
- May be done through a boring or open excavation.
- The location of the test shall correspond to the BMP location.
- Upon completion of the testing, the casings shall be immediately pulled, and the test pit shall be back-filled.

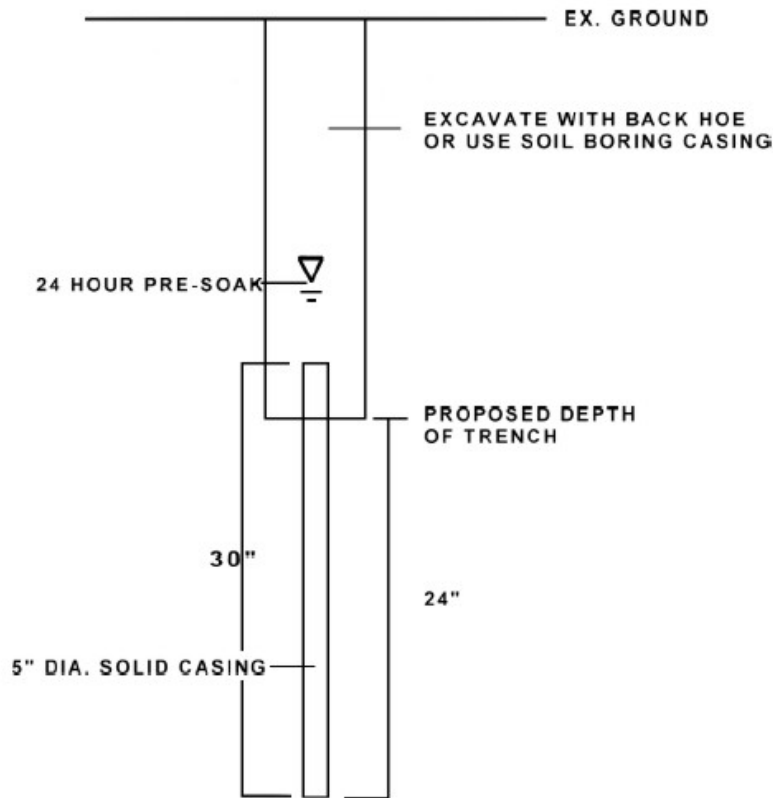

Figure C-1 Infiltration Testing Requirements (MDE, 2002)

Laboratory Testing

Use grain-size sieve analysis and hydrometer tests (where appropriate) to determine USDA soils classification and textural analysis. Visual field inspection by a qualified professional may also be used, provided it is documented. Laboratory test cannot be used to establish infiltration rates.

Bioretention Testing

All areas tested for application of biofiltration facilities shall be back-filled with a suitable sandy loam planting media. The borrow source of this media, which may be the same or different from the bioretention area location itself, must be tested as follows:

- If the borrow area is undisturbed soil, one test is required per 200 square ft of borrow area.
- The test consists of “grab” samples at one foot depth intervals to the bottom of the borrow area.
- All samples at the testing location are then mixed, and the resulting sample is then lab-tested to meet the following criteria:
 - < USDA minimum textural analysis requirements. A textural analysis is required from the site stockpiled topsoil. If topsoil is imported, then a texture analysis shall be performed for each location where the topsoil was excavated. Minimum requirements:

-
- sand 60 - 80% and silt/clay 20 - 40% (#10% clay)
- < Soil shall be a uniform mix, free of stones, stumps, roots or other similar objects larger than one inch.
 - < Consult the bioretention construction specifications (Section 7) for further guidance on preparing the soil for a bioretention area.